

GUIDE

RF-651

REVISED VERSION
SEPTEMBER 2010



SAFEGUARDING OF HYDRAULIC POWER PRESS BRAKES

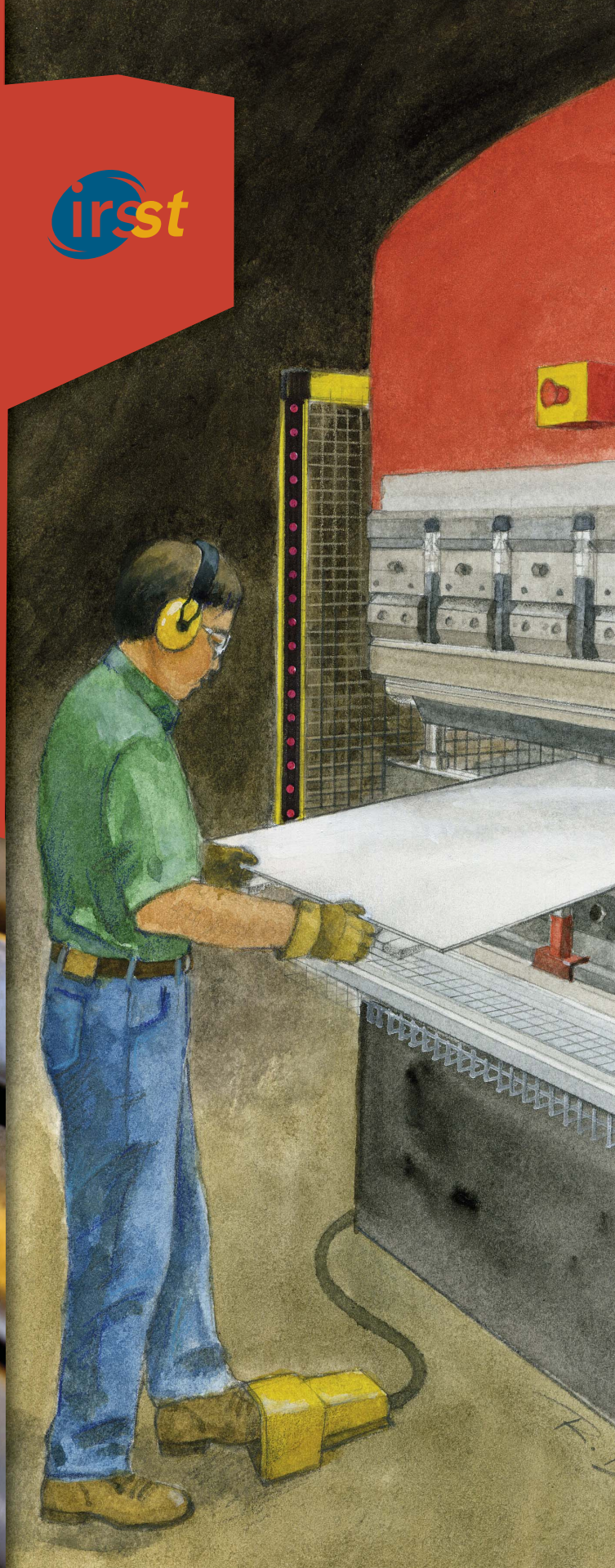
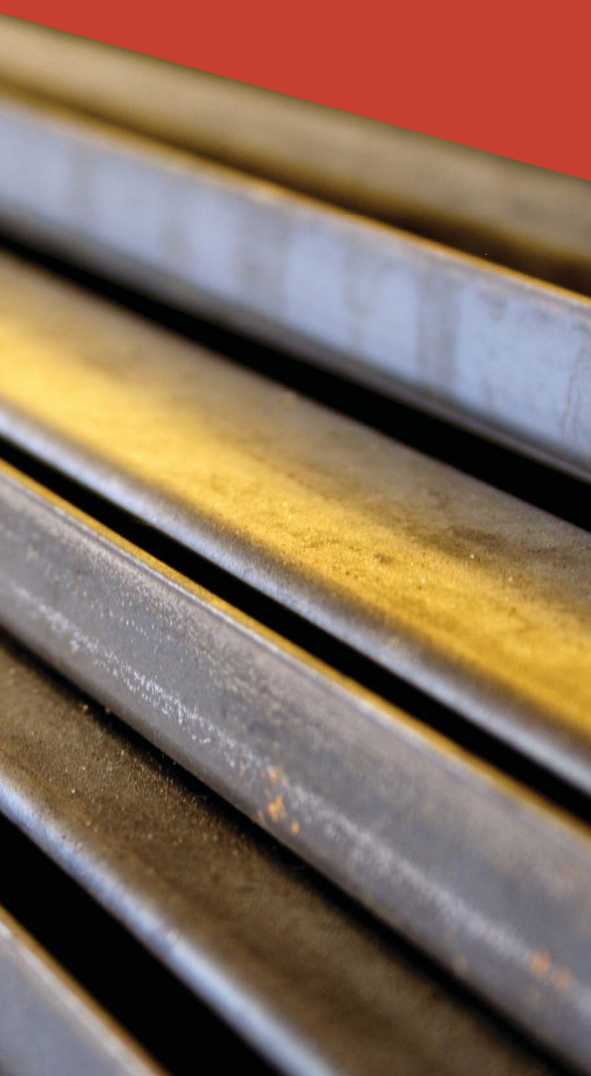

GUIDE

RF-634

REVISED VERSION
SEPTEMBER 2010

SAFEGUARDING OF HYDRAULIC POWER PRESS BRAKES

Page 18 of this document was corrected in September 2010.

All IRSST documents and related updates,
if any, are available on IRSST's Web site.



SAFEGUARDING OF HYDRAULIC POWER PRESS BRAKES

Authors

Damien Burllet-Vienney, Sabrina Jocelyn and Renaud Daigle, IRSST
Serge Massé, Sécurité-Machines S. Massé

Coordination

Laurent Gratton and Marie-France d'Amours, Knowledge Transfer and Partner Relations Department, IRSST

Collaboration

Marjolaine Thibeault, Communications Division, IRSST

Acknowledgements

We want to thank Guillaume Lemieux and Yuvin Chinniah for their research on the safeguarding of hydraulic power press brakes as well as the members of the follow-up committee who participated in the production of this document: Tony Venditti and Waguih Geadah, Association sectorielle fabrication d'équipement de transport et de machines; Guillaume Côté and Serge Simoneau, Association paritaire pour la santé et la sécurité du travail Secteur fabrication de produits en métal et de produits électriques et des industries de l'habillement; and Denis Leblanc, CSST.

We also want to thank the companies Venmar Ventilation Inc. and Bombardier Aerospace that did not hesitate to share their invaluable experience on the safeguarding of hydraulic power press brakes with the IRSST. Finally, we want to acknowledge the help of Mathieu Billette and Christophe Guignolet, integrators of safety devices on hydraulic power press brakes.

Legal deposit

Bibliothèque et archives nationales

September 2010

ISBN: 978-2-89631-499-7 (PDF)

ISSN: 0820-8395

IRSST - Institut de recherche Robert-Sauvé en santé et en sécurité du travail

505 de Maisonneuve Blvd. West

Montréal (Québec)

H3A 3C2

Telephone: 514 288-1551

Fax: 514 288-7636

www.irsst.qc.ca

**SAFEGUARDING
OF HYDRAULIC
POWER PRESS
BRAKES**

TABLE OF CONTENTS

1. Preamble	3
2. Knowing your hydraulic power press brake	5
3. Production variables are determining factors	8
4. Safeguarding your hydraulic power press brake: choices and compromises	10
A. Safeguarding the front zone	10
Opening reduced to 6 mm (Intrinsic prevention)	11
Safety light curtain (Protective device for everyone located in the front zone)	12
Laser beam device (Protective device for persons nearby).....	16
Two-hand control device (Protective device for the sole person using it)	20
B. Safeguarding of rear and side zones	22
Electro-sensitive devices	22
Movable guard with interlocking device	23
Fixed guard	23
5. Complementary means for risk reduction	24
6. Adapted solutions	
A. Use of the opening reduced to 6 mm	27
B. Use of an obliquely positioned safety light curtain	28
C. Use of two safety light curtains on the same press	29
7. References	30
8. Appendices	31
A. Safety distance for safety light curtains and two-hand control device on a hydraulic power press brake	31
B. Stopping distance for laser beams	31
C. Reliability of the safety-related control system	32
D. Reliability of the safety-related hydraulic system	32

MAIN DOCUMENTS FOR CONSULTATION

Québec Act and Regulation (obligations)

Quebec. *Act respecting occupational health and safety. Section 51.* R.S.Q, c. S-2.1, 2007.

Quebec. *Regulation respecting occupational health and safety. Sections 172 to 193.* S-2.1, r.19.01, 2002.

Standards (technical measures)

British Standard Institution. *Safety of machine tools – Hydraulic press brakes.* [Brussels] BS EN 12622: 2009, 2009.

Canadian Standard Association. *Safeguarding of machinery.* [Mississauga] CSA Z432-04, 2005.

Canadian Standard Association. *Code for Power Press Operation: Health, Safety, and Guarding Requirements.* [Mississauga] CSA Z142-02, 2002.

International Standard Organization. *Safety of machinery – Risk assessment. Part 1: Principles.* [Geneva] ISO 14121-1: 2007, 2007.

Guides (for information purpose only)

Centre Technique des Industries Mécaniques. *Mise en conformité des presses-plieres hydrauliques, Fiches-conseils.* CETIM 6D25, 2001, 10 p.

Institut National de Recherche et de Sécurité. *Travailler en sécurité sur les presses plieuses hydrauliques.* ED 879, 2001, 20 p.

Institut National de Recherche et de Sécurité. *Presses plieuses hydrauliques : spécifications techniques à l'usage des utilisateurs, des préventeurs et des rénovateurs.* ED 927, 2004, 64 p.

PREAMBLE

1.

Objective

The objective of this document is to inform companies about the means available for safeguarding hydraulic power press brakes, while emphasizing the two most recent solutions: the safety light curtain and the laser beam device.

Targeted users

This document is aimed at everyone involved in the decision-making process relating to the safeguarding of hydraulic power press brakes: engineers, company owners, CSST inspectors, etc. As a corollary, users of the document must have knowledge about hydraulic power press brakes in general, and about their own presses in particular.

Prerequisites

The protective devices mentioned in this document (safety light curtain, laser beam, two-hand control) are based on the ram's stopping capacity. It is therefore essential that this stopping capacity be known in terms of reliability and repeatability before considering using the devices mentioned.

Logical structure of the document

The first part of the document, *Knowing your hydraulic power press brake*, is intended to introduce certain concepts and the vocabulary. The parts that follow are developed around the idea that each job may require its own guarding method (CSA Z142-02, clause 9.6.2). In other words, one must begin by defining the production variables in order to choose the means of safeguarding that is best adapted to the front zone (see figure below). Furthermore, safeguarding of the side and rear zones must not be disregarded, and complementary risk reduction methods must be integrated, if possible, in order to improve the overall safety of the press.

Limitations of the document and its use

- This document addresses the safeguarding of a single type of press: the hydraulic power press brake.
- The information that it contains is general in nature, which makes it applicable to any type of hydraulic power press brake.
- The means of safeguarding proposed in the guide for the front zone were chosen for the production activity. By production activity, we mean the period during which the operator bends material with the press. For activities other than production (e.g., changing of dies, adjustment of safety devices, maintenance, cleaning, etc.), a risk assessment will have to be done in order to determine the appropriate means of safeguarding.

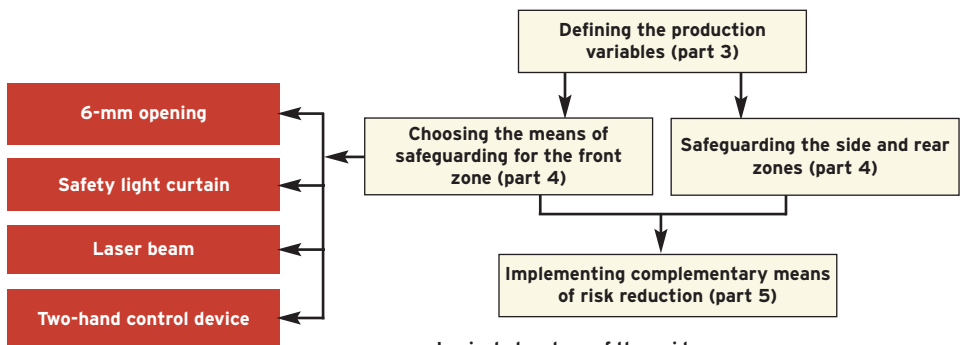

Logical structure of the guide

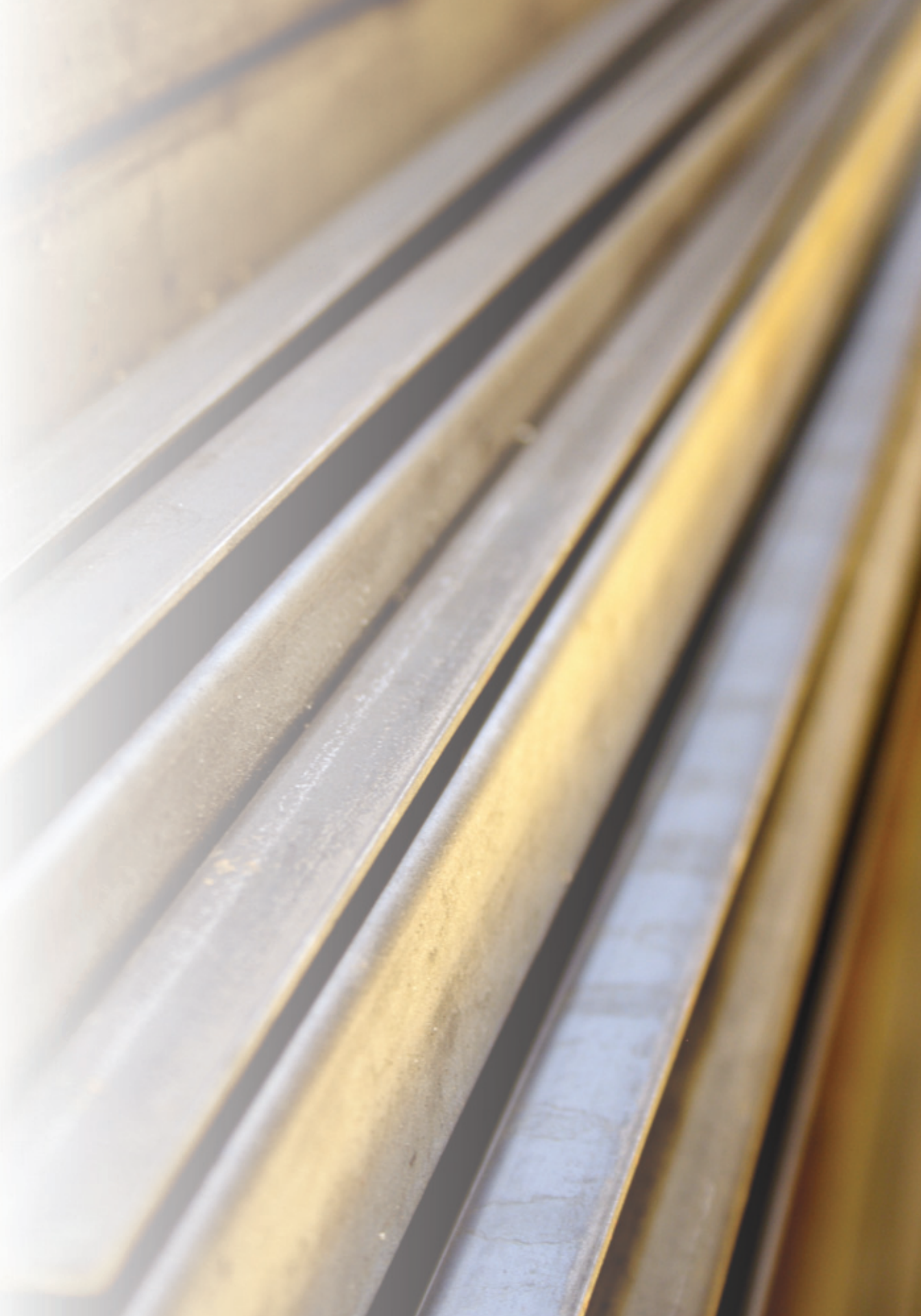

KNOWING YOUR HYDRAULIC POWER PRESS BRAKE

2.

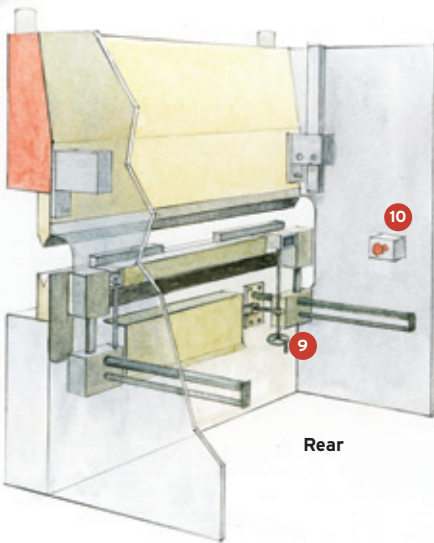

Rear

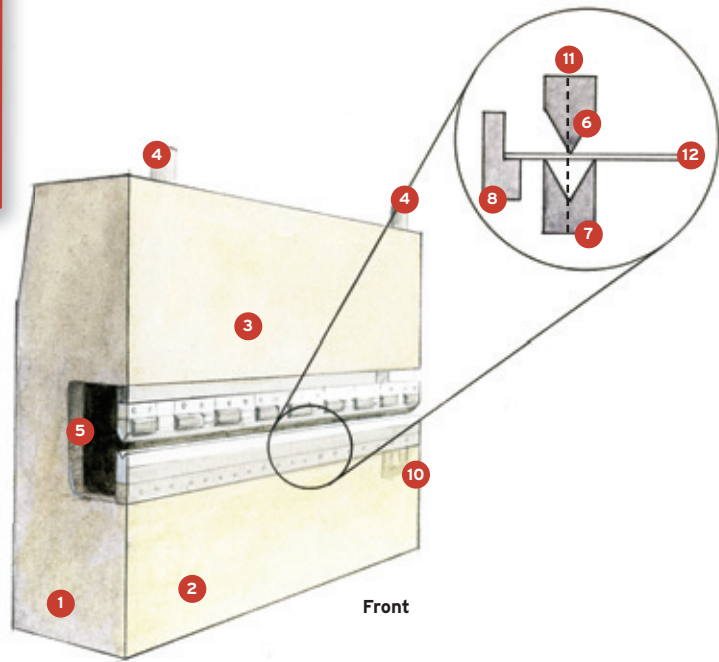

Front

Main components of a hydraulic power press brake

There are two types of hydraulic power press brakes: a power press brake with an upper ram and a power press brake with a lower ram.

The illustrations above show the main components of a hydraulic power press brake with an upper ram, without detailing the means of safeguarding since these will be discussed later.

The glossary and the explanations introduce the vocabulary for the remainder of the document.

- 1 **Machine frame:** Structure of the machine.
- 2 **Table:** Fixed part of the press brake that holds the die (here, the lower die) on a press brake.
- 3 **Ram:** Mobile part of the alternating-movement press brake that holds the die (here, the upper die) on a press brake.
- 4 **Pressure actuator (cylinder):** Actuator that uses hydraulic energy to move the ram.
- 5 **Digital control panel:** (not illustrated) Human-machine interface that allows the operator to control the press brake (e.g., Load a bending program, adjust the speed of movement of the ram and the automatic positioning of the back gauges, etc.)
- 6 **7 Die:** Tool consisting of an upper part and a lower part for bending pieces of metal.
- 8 **Back gauge:** Component, located behind the dies, that is used for depth positioning of the material to be bent.
- 9 **Back gauge adjustment mechanism:** Mechanism for adjusting the position of the back gauges. This mechanism can be manual or automatic.
- 10 **Emergency stop button:** (depending on the standard) Mushroom-shaped red button that, once depressed, immediately initiates the emergency stop sequence. It must remain depressed until the operator releases it. Its resetting must not initiate a system restart.
- 11 **Bending axis**
- 12 **Material for bending (metal sheet)**

Reference positions of the ram

- The safety point, or the point at which the electro-sensitive protective device (safety light curtain, laser beam) is programmed to be deactivated, is generally located 6 mm above the material to be bent. This concept of 6 mm above the sheet is acceptable for components whose thickness is less than 2 mm (8 mm total opening between the dies).
- The working speed switching point is the point at which the ram goes from the approach speed (Speed > 10 mm/s) to a slower speed to work the sheet (Speed < 10 mm/s). Depending on the adjustments, this point and the safety point may be the same.
- For a press brake with a lower ram, the points in the figure below would be reversed.

Mode of operation

On a hydraulic power press brake, the ram moves as the result of a continuous action by the operator on the control device, with the obligation of releasing it at the end of the cycle, for another cycle to start. During the downward motion, when the operator releases the control, the ram stops moving.

The most common control devices on a press brake are the control pedal (e.g., 2 positions, 3 positions, two pedals) or the two-hand control device.

Remember that:

1. Control pedals do not protect the worker. Their associated means of safeguarding (safety light curtain, laser beam device, etc.) will fulfill this function.
2. The two-hand control device is first a control device. It becomes a means of safeguarding only under certain conditions for the sole worker who is using it (see page 20).

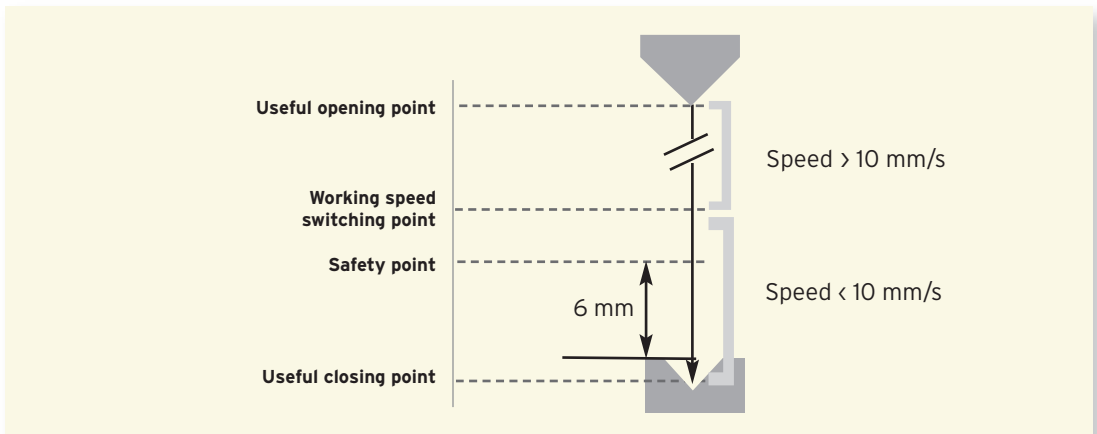

Reference positions of a press brake with upper ram

Hazards and possible damage

On a hydraulic power press brake, several zones must be protected: the rear zone, the side zones and the front zone.



Press brake zones to be safeguarded, top view

Hazards	Hazardous situations	Damage	Zones to be protected
Movement and cutting shape of the die	Being located in the pinch zone between the lower and upper dies.	Crushing Cuts Amputation Death	Front zone Rear zone Side zones
Sheet return movement	Being located near the zone between the material to be bent and the part of the press towards which the sheet return movement occurs.	Abrasions Bruises Cuts	Front zone Side zones
Movement of motorized back gauges	Being located near the back gauges and their drive mechanism.	Abrasions Bruises Cuts Fractures	Rear zone Side zones

Hazards and possible damage by a hydraulic power press brake

PRODUCTION VARIABLES ARE DETERMINING FACTORS

3.



Each job may require its own guarding method (CSA Z142-02, clause 9.6.2).

There is no single solution for safeguarding a press brake; the best-adapted means of safeguarding will depend on how the press brake is used.

Therefore, the first step before anything else is to define the production variables associated with the press brake that have a direct impact on the choice of the future means of safeguarding. For each press, the questions to ask are:

1. What parts are produced on the press brake?

The dimensions and weight of the sheets to be bent are variables to be determined to know whether:

- The sheet will have to be supported by one or more people during the approach phase and the working phase.
- The width of the sheet will be larger or smaller than that of the press, mainly when lateral means of safeguarding are present.

2. What bends are done on each part? And in what order?

The types of bends performed on the press brake are important in choosing a safeguarding device. They establish:

- the distance separating the fingers from the dies for each bend (to be compared with the safety distance [see Appendix 8.A]);
- whether the part can be introduced and removed between the dies by using the opening reduced to 6 mm;
- whether the part must be removed from a side of the die;
- whether the presence of perpendicular or complex bends could prevent the use of some safety devices.

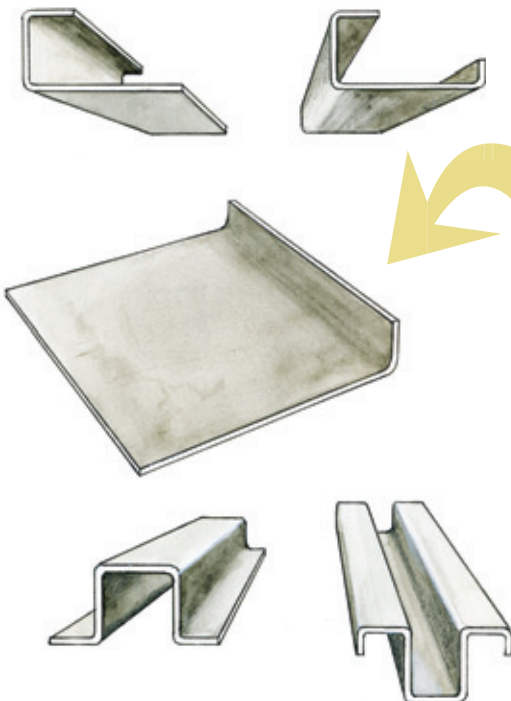

3. What is the size of the production associated with the press brake?

The quantity of identical parts to be produced in the same serie has an impact on the choice of means of safeguarding mainly because of the adjustment time between batches. The smaller the size of the batch, the greater the necessary flexibility and rapid adjustment of the means of safeguarding.

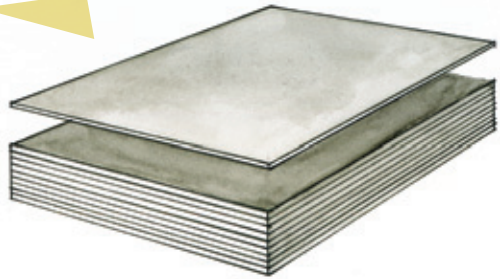

4. What is the state of the material to be bent?

The sheets to be worked can be corrugated, curved or even too flexible when they are thin, which can complicate the use of some means of safeguarding.



5. What dies are used?

The height and shape of the dies that are used must be known because they may not be compatible with some means of safeguarding (e.g., a laser beam device cannot be used with a die such as the one illustrated on the right).

Furthermore, it must be determined whether the press will be used for other activities (shaping, etc.) that use different types of dies.



SAFEGUARDING YOUR HYDRAULIC POWER PRESS BRAKE: CHOICES AND COMPROMISES

4.A SAFEGUARDING THE FRONT ZONE

SUGGESTION FOR A PROCEDURE

1. Survey

- Of all parts produced on the press brakes.
- Of all the bends on each of the parts.
- Of the bend sequence for each part to be produced.
- Of the distance of the fingers from the dies for each bend in each part.

2. Classification of parts

The parts to be produced with the same characteristics must be grouped together.

For example:

- Parts that require that fingers be very close to the dies in order to put them between the dies or support them during bending.
- Parts that require handling by more than one person (dimensions, stiffness, weight, etc.).
- Thick parts.
- Parts that can be produced in large or small lots.
- Parts that will require removal from the side of the die after the bend is executed.

3. Measurements and calculations of stopping times and distances of hydraulic power press brakes to be safeguarded (see appendices)

4. Standardization of the height of the dies in order to simplify safeguarding of the press brake (see part 5)

5. Choice of means of risk reduction by press brake, for all of the parts produced on it:

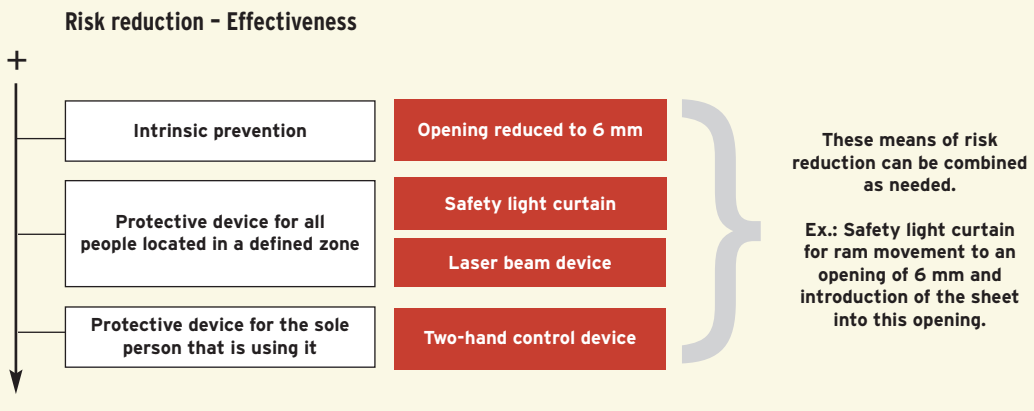

OPENING REDUCED TO 6 MM (Intrinsic prevention)

Description

The danger zone opening reduced to 6 mm is one solution that eliminates the risk at source. With this configuration, there is no longer any risk of introducing a part of the body into this danger zone.

Among the definitions of the opening reduced to 6 mm, we chose to retain the definition of the Centre technique des industries mécaniques (CETIM) and the INRS, which consider the distance between the point of the upper die and the top of the sheet to be bent (definition of the Safety point, page 6):

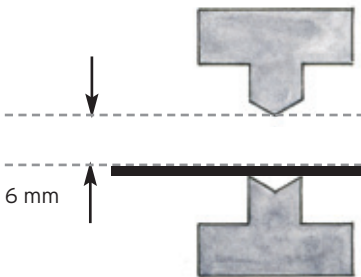

6 mm opening according to CETIM and the INRS

IMPORTANT

This concept of 6 mm above the sheet is acceptable for parts whose thickness is less than 2 mm (8 mm total opening between the dies).

Advantages of the opening reduced to 6 mm

1. Immediate solution that is easy to implement since it requires few or no changes to the press.
2. Inexpensive solution.
3. Protects everyone accessing the space between the dies.
4. Little training and very short adaptation time for operators.
5. Allows the sheet to be supported by the hands.
6. Complies with ROHS and CSA Z142-02 if correctly installed.

Modes of operation

Opening reduced to 6 mm at all times

Safeguarding the press brake by limiting the opening to 6 mm at all times is foreseeable when all the parts can be introduced and removed after the bend or bends have been made, despite this reduced opening.

Intrinsically, this solution is the most effective; however, it remains limited to targeted production: thin sheet, single bend, etc.

Opening reduced to 6 mm in combination with another means of safeguarding

One more flexible way of using the opening reduced to 6 mm is to associate it with a safety light curtain, a laser beam device or even a two-hand control device (see pages 13 and 27).



TIP

Constraints for the opening reduced to 6 mm AT ALL TIMES

1. This procedure applies only if the two conditions below are met:
 - all the parts can be introduced with an opening reduced to 6 mm above the sheet, and
 - all the parts can be removed after bending with an opening reduced to 6 mm either by tipping to the front or by sliding to the side.

SAFETY LIGHT CURTAIN (Protective device for everyone located in the front zone)

REMINDER The safeguarding offered by a safety light curtain is based on the safety distance, which is mainly a function of the ram's stopping time. It is therefore essential that this stopping time be reliable and repeatable before considering using this means of safeguarding (see Appendix 8.A).

Description

The safety light curtain is an electro-sensitive protective device. It consists of a transmitter and a receiver. The transmitter sends small infrared light beams (separated at equal distances) to the receiver. The distance between two beams gives the resolution of a light curtain. If a body crosses one of the beams, a signal to stop or reverse the hazardous movement is given. The resolution of the safety light curtain should be chosen by taking into account the thickness and shape (simple or complex) of the material to be bent.

The safety light curtain is minimally active during the hazardous phase of the cycle: approach phase of the ram until the opening is reduced to 6 mm.

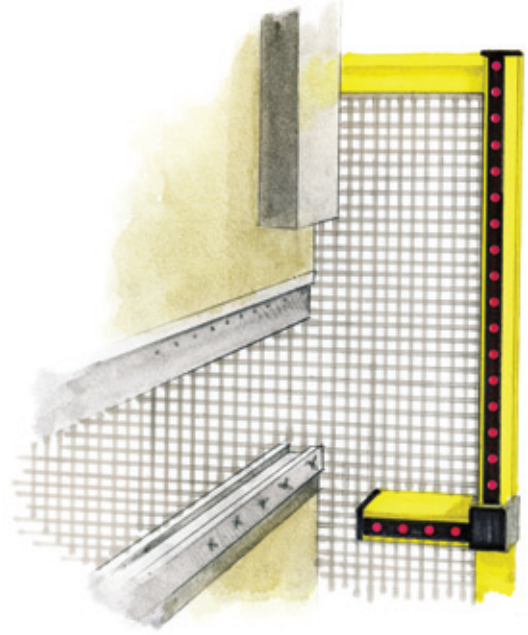

Safety light curtain

Bending modes

With a safety light curtain, a bend can be executed according to two methods described in this box, depending on whether the safety light curtain is obstructed or not, before the bend is executed.

Obstruction can be due either to the part (thickness, perpendicular bend), or to the hand of the operator holding the sheet.

Insertion of the sheet before descent of the table

1. Introduction of the sheet.

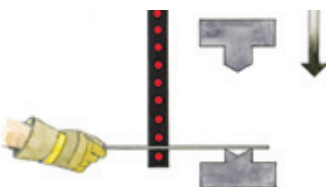

2. Descent of the ram. At 6 mm, the safety light curtain is deactivated. (If deactivation is impossible, see floating blanking later on.)

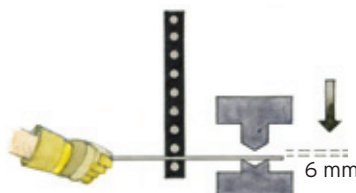

3. Bending and raising of the ram.

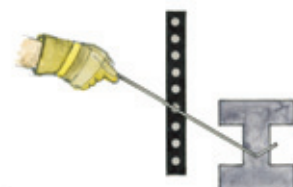

Possible configurations during installation

The safety light curtain can be configured horizontally or vertically. Sometimes these devices are installed obliquely (see page 28) or in combination (see page 29).

Curtain positioning must comply with a certain number of criteria in order to avoid their being bypassed. These criteria are stated, for example, in clause 5.3.12.2 of standard EN12622: 2001.

In all cases, its positioning must comply with a safety distance that allows the hazardous movement to be stopped before the operator can reach the zone where this movement occurs.

Information relating to the calculation of the safety distance for the vertical and horizontal positions is presented in this document's appendix.

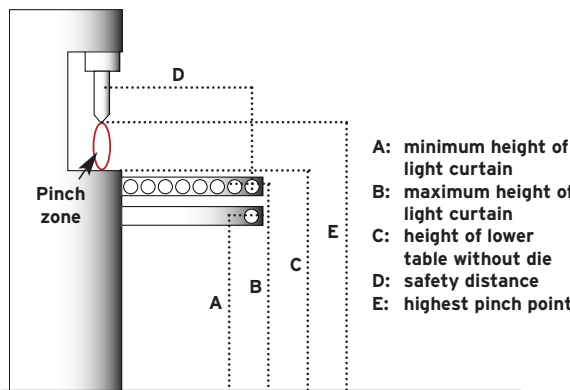

Horizontal safety light curtain

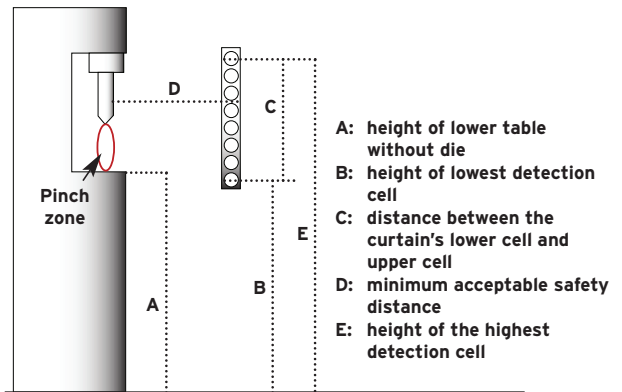

(Source: Ngô, A.D. and al., 1998)

Vertical safety light curtain

This mode of operation is useful for bending boxes or small parts that must be held close to the dies.

Insertion of the sheet into an opening reduced to 6 mm

1. Descent of the ram at high speed.

2. Automatic stop at 6 mm and deactivation of the safety light curtain.

3. Introduction of the part.

4. 2nd pedal press to initiate the descent of the ram.

5. Bending, and raising of the ram.

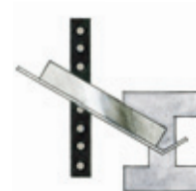
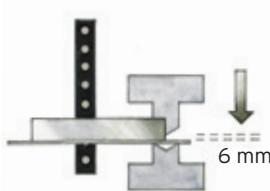
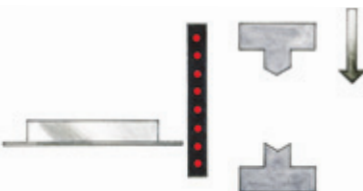

Options available on a safety light curtain

In order to alleviate some production constraints, various operating options exist for a safety light curtain.

IMPORTANT

When beam blanking is authorized or the curtain's response time is changed, **recalculation of the safety distance must be considered.**

Constraint: Permanent obstruction of beams before bending is executed.

Solution: Fixed blanking and deactivation of the safety light curtain at an opening of 6 mm.

When the safety light curtain is used in **fixed blanking mode**, only the beams that were programmed to be obstructed can be obstructed. If another beam is crossed, ram movement will be impossible.

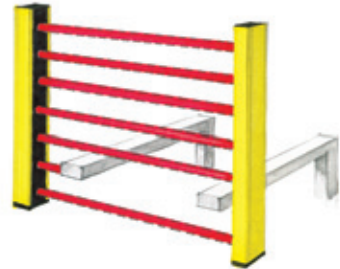

Constraint: Part with multiple bends that obstructs the curtain and that cannot be inserted at 6 mm, or even when blanking at 6 mm is not programmed or not programmable.

Solution: Floating blanking.

Note: This functionality increases the system's response time and therefore the safety distance.

When the **floating blanking mode** is chosen, a programmed number of beams out of all those in the curtain can be obstructed. If a higher number of beams is obstructed, ram movement will be impossible.

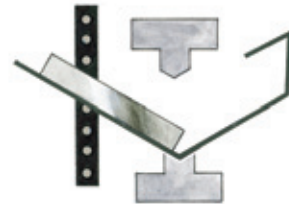

Constraint: Preventing the safety light curtain from systematically ordering the ram to stop when it is unnecessary.

Solution: Multiple scanning.

Note: This functionality increases the system's response time and therefore the safety distance.

When one of the beams is crossed, the protective device memorizes it. During the next scan, if the same beam is still crossed, the protective device orders the hazardous movement to stop or to be reversed.

Constraint: Risk of optical interference during the use of two safety light curtains near each other.

Solution: Beam coding.

Some safety light curtains offer the possibility of **beam coding**. The transmitter sends a coded light pulse train that only its receiver can interpret.

Advantages of the safety light curtain

1. Protects everyone accessing the space between the dies from the zone in front of the press.
2. Complies with ROHS (section 179) and CSA Z142-02 if correctly installed.

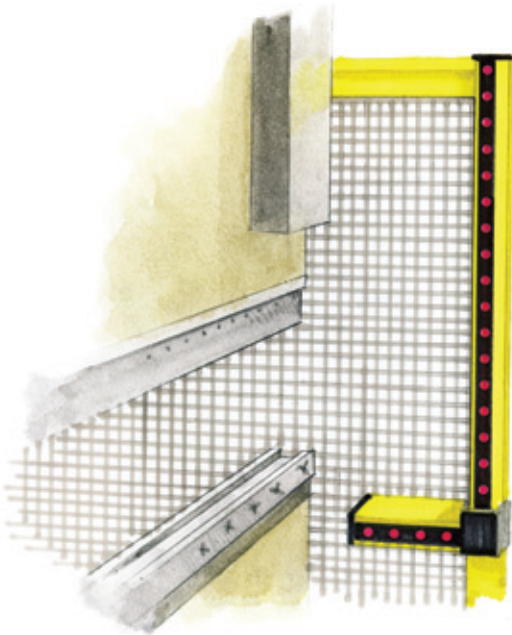

Constraints of the safety light curtain

Temporary during installation

1. Requires revision of the bending sequence, mainly for bending complex parts, so that this sequence is compatible with the mode of operation chosen for the safety light curtain.

Where a solution is foreseeable

2. Makes the bending of small parts impossible, because this requires that the curtain be crossed.
Solution: Insertion through an opening reduced to 6 mm can be considered.
3. (Vertically configured curtain only)
Disrupts production during bending of boxes or complex shapes in general because the geometry of the part causes some of its sides to interfere with the beams of the safety light curtain.
Solution: Floating blanking of the curtain can be one solution. Insertion into an opening reduced to 6 mm can be another solution because the curtain deactivates once this spacing is reached.

Permanent

4. (Vertically configured curtain only)
May represent an obstacle for a part exceeding the width of the press or for parts requiring removal from the side of the press.
5. (Horizontally configured curtain only)
May increase the amplitude of the operator's movements.

Additional information

Additional information related to safety light curtains is available in standards IEC/EN 61496 (2004) *Safety of machinery – Electro-sensitive protective equipment*, and IEC/TS 62046 (2008) *Safety of machinery - Application of protective equipment to detect the presence of persons*.



LASER BEAM DEVICE (Protective device for persons nearby)

REMINDER The safeguarding offered by a laser beam device is based on the ram's stopping distance. It is therefore essential that this stopping distance be known, reliable and repeatable before considering using this means of safeguarding (see Appendix 8.B).

Description

Laser beam devices or camera systems are electro-sensitive devices that use a LASER-type light source in the infrared spectrum. They detect any intrusion between the upper die and the lower die, until the laser beam is 6 mm from the sheet. At less than 6 mm, the laser beam device is deactivated.

The laser beam device is attached to the upper table and is height adjustable. For positioning in relation to the die on the ram, the following must be taken into account:

- the distance between the highest laser beam and the point of the upper die, which must not allow a finger to enter without it being detected,
- the ram's stopping distance.

Furthermore, the associated control device for closing the dies must be a three-position pedal control [OFF/ON/Emergency stop]. This pedal must be maintained in an intermediate position to allow the dies to close.

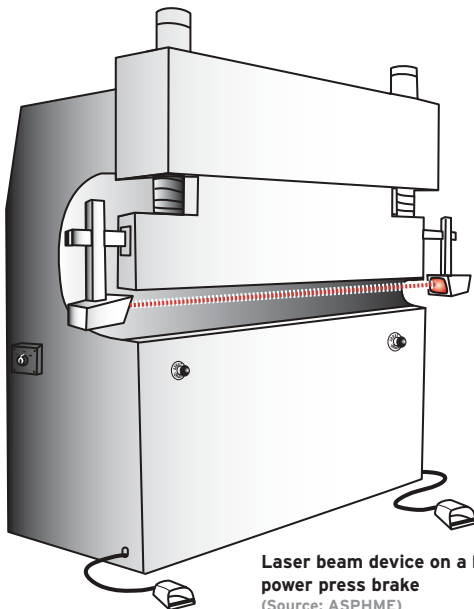

Laser beam device on a hydraulic power press brake
(Source: ASPHME)

Modes of operation

Detection under the upper die is done in three zones: front (zone 1), central (zone 2) and rear (zone 3). The modes of operation available are:

1. Regular mode in which the three detection zones are active. This figure case is possible, for example, during a first bend. The operator has maximum protection in this mode.
2. Box mode, in which the front zone is deactivated to avoid stopping due to a perpendicular bend.
3. Box and back gauges mode in which only the central zone is active. The front and rear zones are deactivated to avoid stopping due to a perpendicular bend and the presence of the back gauges as with a bend near the edge.

The last two modes should be used only when necessary because the press is being operated with reduced safety.

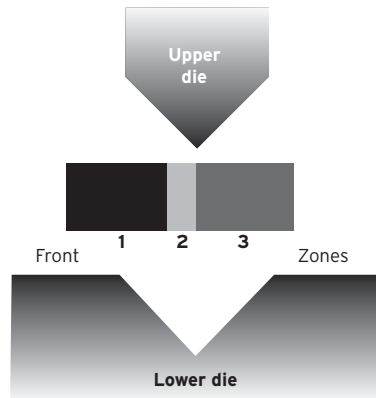

Detection zones of a laser beam device

Products available

Each manufacturer has developed his own method for protecting the operator: protection volume, vertical lines, horizontal lines, etc. In 2008, five manufacturers were identified, and their proposed products generally use the three modes of operation explained above, and can be used in category 4 safety circuits according to ISO 13849-1: 2006.

MANUFACTURERS AVAILABLE PRODUCTS/INFORMATION

FISSLER
ELEKTRONIK

AKAS I, II, III et LC

Detection:

- 3 laser beams in L formation.
- Response time of 25 ms.

Characteristics:

Automated adjustment of the height (except LC).

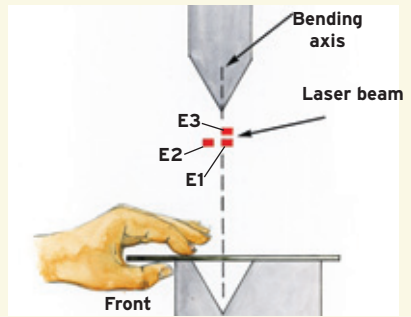

AKAS II from Finessler
Source: www.finessler.com

LAZER
SAFE

Série LZS

Detection:

- Horizontal detection line 40 mm wide divided into three.
- Response time of 12 ms.

Characteristics:

Measures the table's stopping distance.

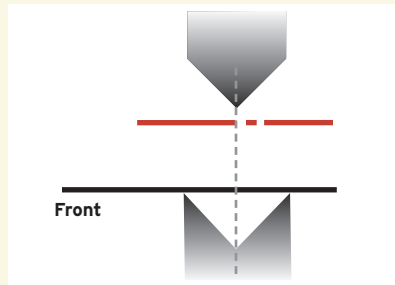

LZS-003 from Lazer Safe
Source: www.machine-outil.com

METAL
TECH

Laser Sentry

Detection:

- 3 laser beams in line.

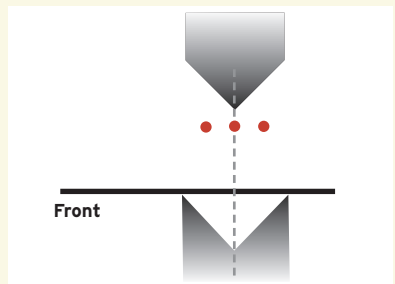

Laser Sentry from Metal Tech
Source: www.metalttechcontrols.com

NUOVA
ELETTRONICA

DFS Laser beam

Detection:

- Curved field of detection consisting of several cells.

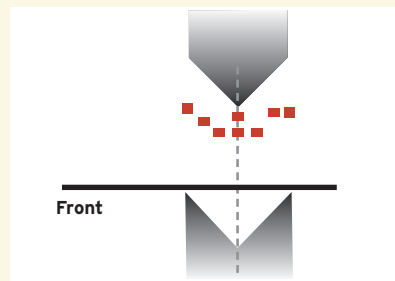

DFS Laser beam from Nuova elettronica
Source: www.trivenetaimpianti.com

MANUFACTURERS AVAILABLE PRODUCTS/INFORMATION

SICK

V4000

Detection:

- Detection volume 40 mm wide by 26 mm high divided into three zones.
- Response time of 10 ms.

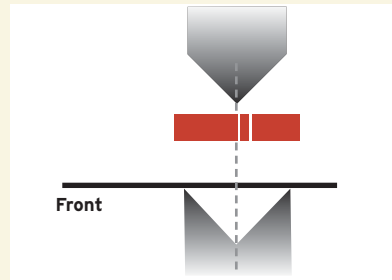

V4000 from SICK
Source: www.sick.com

IMPORTANT

Note: We do not exclude the possibility that in 2008 other manufacturers could have proposed laser beam devices. It is also possible that improvements have been made since 2008 to the different devices. The response times given measure the time between the interruption of a laser beam and the opening of the output relay contacts of the laser beam device.

Advantages of a laser beam device

1. Protects all persons accessing the space between the dies.
2. Limits the frequency of undesirable stops since the detection zone is restricted to the region located directly under the upper die.
3. Allows the sheet to be supported by the hands.
4. Adapts to the manufacture of boxes and small parts as well as to the presence of back gauges in the bending zone.
5. Complies with ROHS (section 179) and CSA Z142-02 if correctly installed.

Additional information

Additional information related to laser beam devices is available in standards IEC/EN 61496 (2004) *Safety of machinery - Electro-sensitive protective equipment*, and IEC/TS 62046 (2008) *Safety of machinery - Application of protective equipment to detect the presence of persons*.

Constraints of a laser beam device

Temporary during installation

1. Requires revision of the bending sequence, mainly for bending complex parts.

Where a solution is foreseeable

2. Height adjustment costly in time for each change:
 - of die
 - of sheet thickness.**Solution:** Some models do this adjustment automatically.
3. Increases unwanted stops when the sheets are not flat.
Solution: A magnet on the working surface of the lower table can reduce the problem.

Permanent

4. May not function with certain shapes of complex dies (e.g., die with several heights).
5. May not function for sheets exceeding the width of the press or that must be removed from a side of the press.

INTEGRATION OF A LASER BEAM DEVICE OR A SAFETY LIGHT CURTAIN

The installation of a laser beam device or a safety light curtain will require changes to your press brake. To improve your chances of having a successful integration, several actions must be considered before, during and after this step.

A successful integration and a planned knowledge transfer can optimize production on press brakes.

Actions to consider BEFORE integrating the device

1. Consult the supplier to ensure that the chosen solution is adapted and complies with Québec regulations as well as with the relevant standards.
2. Make sure that you have the manufacturer's or the supplier's technical support.
3. Have in your possession the hydraulic, electrical and mechanical plans for the press brake.
4. Evaluate:
 - the proper operation of the press brake,
 - the reliability of the safety-related control system (see Appendix 8.C),
 - the reliability of the hydraulic circuit (see Appendix 8.D),
 - the reliability of the electrical circuit,
 - the ram's stopping distance and time.
5. Make sure that you have access to the original programs of the press and that someone in the company has the relevant expertise.
6. Ensure compatibility of the electrical signals and encoders between the safeguarding device and the press brake controls.

Actions to consider WHEN integrating the device

1. Manage the different modes of operation.
2. Manage the approach and working speeds for the press brakes:
 - at a single speed,
 - at a speed varying in relation to the command.
3. Manage, during deactivation of the safeguarding device, the blocking of the press brake at slow speed (< 10 mm/s).

Actions to consider AFTER integrating the device

1. Obtain the electrical and hydraulic plans containing the modifications carried out on the press brake.
2. Receive training on the use of the device and have the user's manuals in your possession.
3. Perform the safety audits on the operation of the safeguarding device at regular intervals (including tests for the ram's stopping time and distance).



TWO-HAND CONTROL DEVICE
(Protective device for the sole person using it)

REMINDER The protection offered by a two-hand control device is based on the safety distance, which is mainly a function of the ram's stopping time. It is therefore essential that this stopping time be reliable and repeatable before considering using this means of safeguarding (see Appendix 8.A).

Description

The two-hand control device is a two-button control device, whose simultaneous and maintained action initiates the start of the ram of the hydraulic press brake and ensures its movement.

To fulfill the role of protective device for the operator who uses it, it is important that the two-hand control device be installed at a safety distance (see Appendix 8.A) that prevents all contact of the operator with the hazards identified for the zone in front of the press.

Since the operator has both hands occupied by the two-hand control device, a sheet support may be installed to support the part.

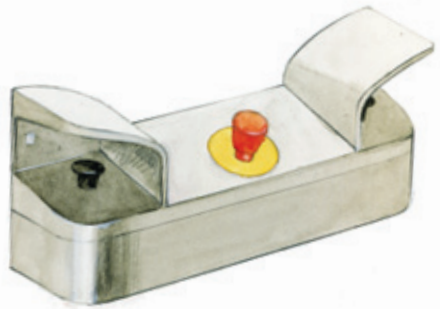

Two-hand control device

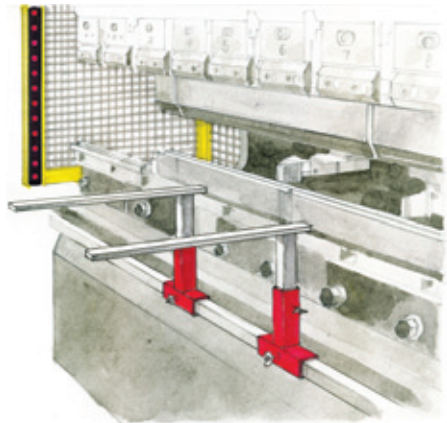

Sheet support

Modes of operation

• **Two-hand control device throughout the entire cycle:**

Bending is done by keeping the two-hand control device depressed until bending is completed.

• **Two-hand control device and pedal:**

1. Movement of the ram with the two-hand control device.
2. Automatic stopping of the ram 6 mm from the sheet to be bent.
3. Bending of the sheet with a pedal to allow the operator to support the sheet during bending.

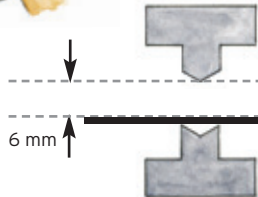

Advantages of the two-hand control device

1. Relatively simple solution.
2. Complies with ROHS (sections 180 and 181) and CSA Z142-02 if correctly installed.

Constraints of the two-hand control device

Where a solution is foreseeable

1. Its use does not allow bending of all types of parts, because the material to be bent may have to be supported by both hands before or during bending.

Solution:

- Install a sheet support (see page 25), and
- Use the two-hand control device and pedal solution to support the sheet during bending.

2. May be the reason for musculoskeletal disorders caused by repeated pushing movements on the buttons.

Solution: A touch-sensitive two-hand control device in order to reduce the effort.

3. Removable two-hand control device must be designed to comply with the safety distance.

Permanent

4. Protects only the person operating it. Plan for ways to safeguard the other people around the press.
5. If there is more than one operator, a two-hand control device is necessary for each one, with a selector switch on the control panel. The selector switch indicates the number of operators involved in bending and forces each of them to activate it for each cycle.

Additional information

When purchasing a two-hand control device, ask the manufacturer that it comply with:

- recognized ergonomic principles (e.g., compliance with CSA Z142-02: Appendix B)
 - the features prescribed by:
 - ROHS: sections 180 and 181,
 - CSA Z142-02: clause 11.3.3,
 - CSA Z432-04: clauses 9.4.7 and 10.9.

SAFEGUARDING YOUR HYDRAULIC POWER PRESS BRAKE: CHOICES AND COMPROMISES

4.B SAFEGUARDING OF REAR AND SIDE ZONES



REMINDER Rear and side zones are also zones to be safeguarded. These zones must therefore be safeguarded during production, while remaining potentially accessible for some specific operations.

ELECTRO-SENSITIVE DEVICES

Definition (ISO 12100 : 2003)

Equipment designed to detect people or parts of their bodies and to send a signal to the control system intended to reduce the risk to which the detected people are exposed. The signal can be triggered when a person or a part of his body goes beyond a pre-established limit - for example, when the person enters a danger zone - (detection of the crossing of a boundary) or while a person is detected in a previously delimited zone (presence detection), or in both cases. (Free translation of French version)

1. Electro-sensitive devices that can ensure safeguarding of the rear zone are, for example:
 - a safety light curtain,
 - a pressure-sensitive mat,
 - a laser scanner,
 - several mono-beams,
 - a combination of these devices.
2. The safety light curtain is the electro-sensitive device that can ensure safeguarding of the side zones.

N.B. These devices must comply with the requirements related to the safety distance principle stated in Appendix 8.A.

Additional information

- CSA Z142-02 clauses 11.3.2., 11.3.5, 11.3.6, 11.3.8, *Code for Power Press Operation: Health, Safety, and Guarding Requirements.*
- IEC/EN 61496-1 and -2 (2004) *Safety of machinery - Electro-sensitive protective equipment.*



**Mono-beams
for the zone behind
the press brake**

MOVABLE GUARD WITH INTERLOCKING DEVICE

Definition (CSA Z142-02)

Movable guard associated with an interlocking device, in such a way that :

- the hazardous press functions “covered” by the guard cannot operate until the guard is closed;
- if the guard is opened while hazardous press functions are operating, a stop instruction is given; and
- when the guard is closed, the hazardous press functions “covered” by the guard can operate, but the closure of the guard does not by itself initiate their operation.

Additional information

- CSA Z142-02 clauses 11.1.3.4.1 and 11.3.1, *Code for Power Press Operation: Health, Safety, and Guarding Requirements*.
- ISO 14119: 1998, *Safety of machinery – Interlocking devices associated with guards – Principles for design and selection*.
- ISO 14120: 2002, *Safety of machinery – Guards - General requirements for the design and construction of fixed and movable guards*.

FIXED GUARD

(Suggested only for the side zones where access is almost never required.)

Definition (CSA Z142-02)

A guard kept in place (i.e., closed) either permanently (by welding, etc.), or by means of fasteners (screws, nuts, etc.) making removal/opening impossible without using tools.

Additional information

- CSA Z142-02 clauses 11.1.3.2 and 11.1.3.3, *Code for Power Press Operation: Health, Safety, and Guarding Requirements*.
- ISO 14120: 2002, *Safety of machinery – Guards – General requirements for the design and construction of fixed and movable guards*.

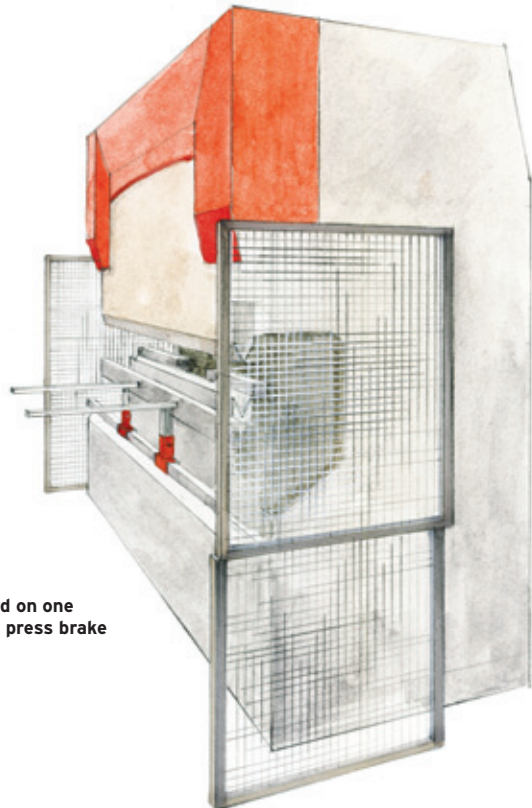

Fixed guard on one side of the press brake

COMPLEMENTARY MEANS FOR RISK REDUCTION

5.

In addition to the proposed means of safeguarding (safety light curtain, laser beam device, etc.), several other means, generally intended to improve production, can be used to reduce risks and consequently, accidents. The list below presents some of them, with their advantages and disadvantages:

BACK GAUGE

Advantages:

- Allows the sheets to be correctly and rapidly positioned with fewer risks if the height of the gauge is sufficient.
- Reduces the number of adjustment interventions when it is automated.

Disadvantage:

- Possibility of crushed fingers or hands between the back gauge and another part of the press.

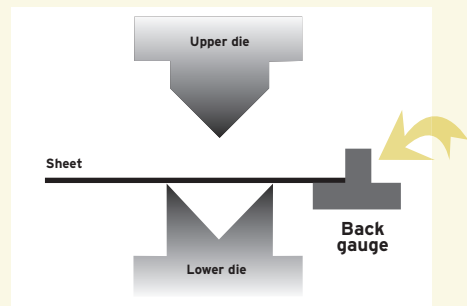

FRONT GAUGE

Advantages:

- Allows the sheets to be correctly and rapidly positioned with fewer risks.
- May also serve as a fixed sheet support.

Disadvantages:

- May disturb the proper operation of a safety light curtain.
- Possibility of pinching and crushing between the front gauge and the sheet.

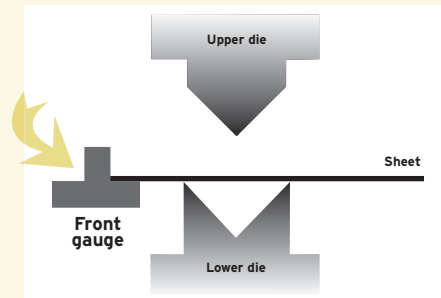

LATERAL GUIDE

Advantage:

- Allows the sheets to be correctly and rapidly positioned with fewer risks.

Disadvantages:

- May disturb the proper operation of a safety light curtain.
- Possibility of pinching and crushing between the lateral guide and the sheet.

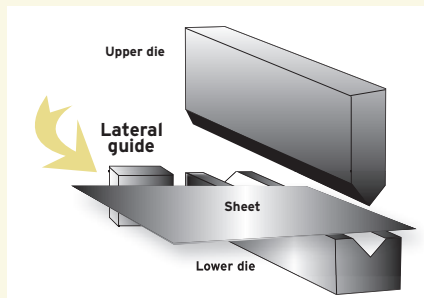

SHEET SUPPORT AT THE LEVEL OF THE LOWER DIE

Advantages:

- Facilitates the positioning of the parts without having to support them.
- If motorized, it moves to follow the movement of the sheet while supporting it during bending.
- May allow the use of a two-hand control device.

Disadvantages:

- May be detrimental to the proper operation of a safety light curtain.
- Possibility of pinching and crushing between the sheet support and the sheet.

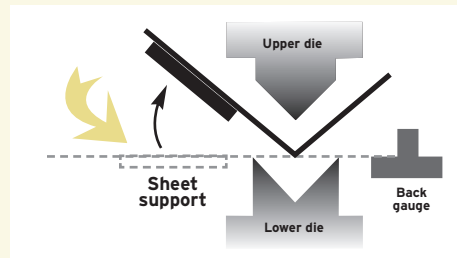
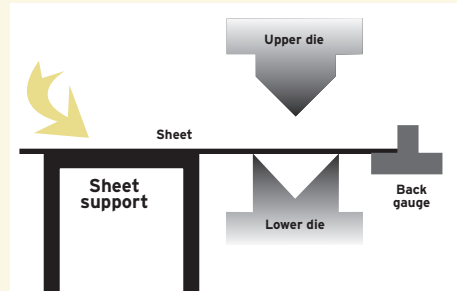

MAGNET FOR HOLDING THE SHEET

Advantages:

- Allows small parts to be held in place to start the bending.
- May allow the use of a two-hand control device.
- Eliminates the curves in the sheet if the magnet is strong enough.
- If it is an electromagnet, it can be synchronized with the bending sequence to increase its benefits.

Disadvantages:

- To remove the part, a magnet that is too powerful may force the operator to lean with one hand on one of the two dies and thus have his fingers in the danger zone.
- Magnets are not effective for bending aluminum, stainless steel or plastic materials.

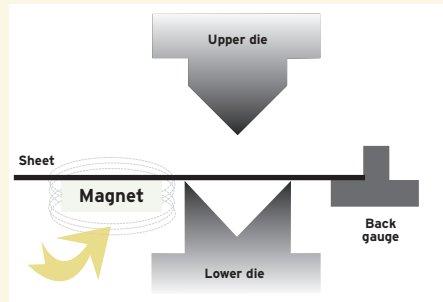

ADAPTED-WIDTH DIES TO THE SHEET

Advantage:

- Makes it possible to eliminate the crushing risks on the die sections that are not necessary for bending.

Disadvantage:

- May require frequent changes of dies for small series.

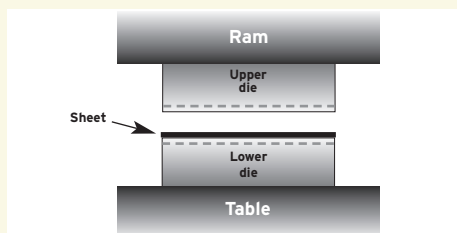

USE OF A HOIST

Advantages:

- Allows heavy parts to be handled, and also avoids certain risks of back pain, impacts, crushing, etc.
- May allow fewer operators to be mobilized.

Disadvantage:

- Requires a lot of vigilance if several operators are working together.

AVOIDING HAZARDOUS BENDING THROUGH PARTS DESIGN

Advantages:

- Eliminates bending that can be dangerous to perform. (e.g., Bends that create sheet return movement, those that are too close to the edge, etc.).
Note: Consulting press brake operators before finalizing the design of the part could be one approach to consider.
- Avoids designing large parts that have to be removed from the side, and as a result, rendering some means of safeguarding unusable (safety light curtain, laser beam device, lateral guards).

PROGRAMMING THE BENDING SEQUENCE

Advantages:

- Makes it possible to avoid situations in which the opening of the dies is larger than necessary (thickness of the part + 6 mm) to release the parts.
- Limits the blanking of some or all of the safety device (e.g., safety light curtain) to make the final bends.
- Makes it possible to avoid parts hanging behind the dies and therefore the part tipping behind the press.

UNIFORMIZATION OF DIE HEIGHT

Advantages:

- Reduces the interventions and adjustment times for dies.
- May allow several series of parts to be produced without readjusting the safety devices (e.g., laser beams).

TRAINING OF OPERATORS AND MAINTENANCE STAFF

Advantages:

- Allows accidents to be avoided through better knowledge of hydraulic power press brake operation and of the bending process.
- Helps minimize bypasses if the worker is trained in the operation and use of means of safeguarding.
- Allows personnel to be more efficient in press maintenance and operation.

SPEED REDUCED TO 10 MM/S AND 3-POSITION PEDAL [OFF/ON/EMERGENCY STOP]

The reduction of the ram's speed to 10 mm/s and the use of the 3-position pedal reduce the risk by increasing the possibility of avoiding harm.

- This measure is not a means of safeguarding, but is instead a means of risk reduction. It therefore does **not comply with ROHS** according to section 182. It is a **last resort or temporary measure** when it is impossible to safeguard the press brake in another way, or even when the existing safety device must be bypassed.

If this method is permanently installed, there must be proof that it is the only method available for risk reduction.

ADAPTED SOLUTIONS

6.A USE OF THE OPENING REDUCED TO 6 MM

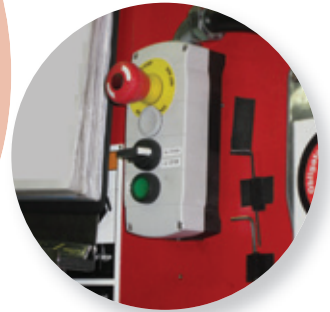

Context

1. Hydraulic power press brake with lower ram.
2. Use of a safety light curtain as means of safeguarding - Blanking of the safety light curtain 6 mm above the sheets.

Problem

Except for a few bends, those done on this press brake can be safeguarded by installing a safety light curtain. The few bends that pose a problem are called consecutive bends where the operator has his hands very close to the dies.

Solution

Combining the use of a safety light curtain and the opening reduced to 6 mm for the consecutive bends that pose a problem:

1. Closing the dies until the opening is reduced to 6 mm, with the safety light curtain active.
2. Blocking the lower ram at this opening by means of the hydraulic circuit.
3. Deactivating the safety light curtain.
4. Using the control device, selecting the number of bends at the opening reduced to 6 mm.

5. Inserting the sheet and executing the consecutive bends at an opening reduced to 6 mm.
6. Opening the dies to remove the part, and reactivating the safety light curtain.

Necessary adjustments

- Adding to the hydraulic circuit a system allowing blocking of the lower ram at an opening reduced to 6 mm.
- Adding a control device in order to select the number of consecutive bends at an opening reduced to 6 mm.

Advantages

- Safeguarding of the press brake for all bends was achieved at reduced cost.
- A gain in productivity was achieved by reducing the unnecessary movements of the ram.

ADAPTED SOLUTIONS

6.B USE OF AN OBLIQUELY POSITIONED SAFETY LIGHT CURTAIN

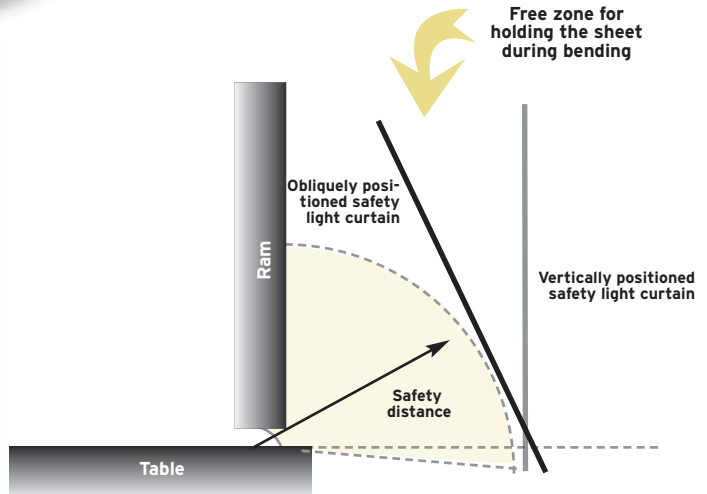

Context

1. Hydraulic power press brakes with upper ram.
2. Use of a safety light curtain as means of safeguarding
- No blanking of the safety light curtain 6 mm above the sheets.
3. Sheets longer than the safety distance.

Problem

- a) On this press brake, the safety light curtain is active throughout the entire descent of the ram. In fact, the curtain is not blanked 6 mm above the sheet due to the absence of technical means for measuring these 6 mm.
- b) The operators have to hold the sheets before and during bending.

Solution

- a) Since the safety light curtain is active during bending, the floating blanking mode (see page 14) must be used to allow several beams to be obstructed by the sheet when it is being bent.

- b) The curtain was installed obliquely in order to allow the operator to hold the sheet during bending. In fact, the inclination of the curtain creates an additional zone (compared to a vertically positioned curtain) where the operator can accompany the movement of the sheet during bending without his hands crossing the safety light curtain and initiating the stopping of the press brake (see the figure above).

Necessary adjustments

- The use of floating blanking requires recalculation of the safety distance based on the number of beams that it is allowed to obstruct.
- Positioning of the oblique curtain in such a way that it is at a distance greater than or equal to the safety distance along its entire length.

Advantage

The oblique configuration gives more space for the operator to hold the sheet with his hands during bending, when the safety light curtain is active throughout the descent of the ram.

ADAPTED SOLUTIONS

6.C USE OF TWO SAFETY LIGHT CURTAINS ON THE SAME PRESS

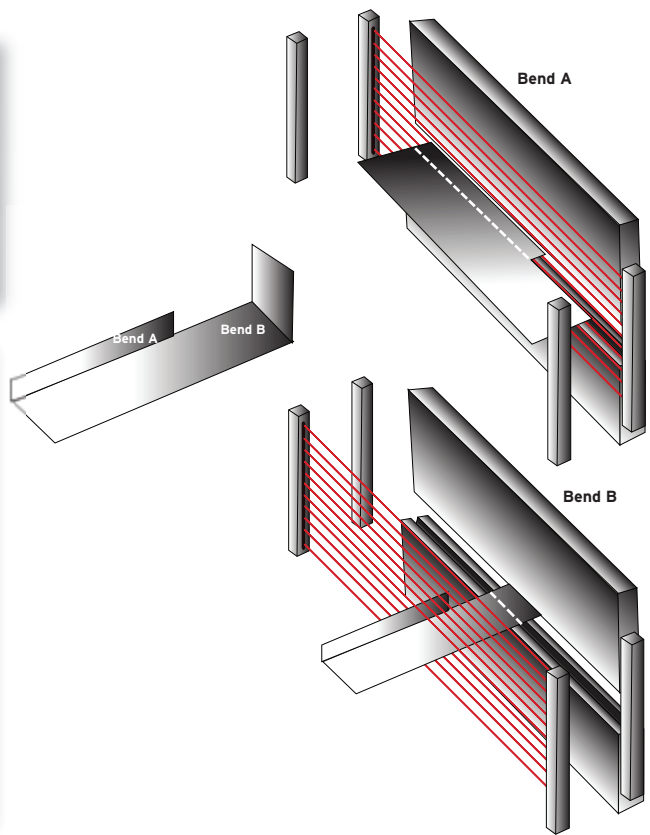

Context

1. Hydraulic power press brakes with upper ram.
2. Use of the safety light curtain as means of safeguarding - Blanking of the safety light curtain 6 mm above the sheets.
3. Parts with perpendicular bends and variable bend lengths.

Problem

On this hydraulic power press brake, there may be parts as in the above example with:

- a) a first simple bend, bend A, without beam obstruction before the bend is done, but where the hands are close to the dies (compliance with the safety distance may be difficult).
- b) a perpendicular bend, bend B, with beam obstruction before the bend and therefore the use of floating blanking (safety distance is greater with floating blanking than without it).

In this case, two safety distances are necessary:

- a short safety distance for bend A due to the hands being close to the dies and the absence of floating blanking, and
- a longer safety distance for bend B due to floating blanking.

Solution

The installation of two safety light curtains at the desired safety distances. These two safety light curtains are active, in turn, depending on the bend to be performed. For example, for bend A, the curtain with the shortest safety distance will be activated and the other deactivated. For bend B, the opposite will occur.

Necessary adjustments

Activation and deactivation of the safety light curtains must be controlled in a safe way by means of, for example, a safety programmable logic controller.

Advantage

This solution offers a lot of flexibility in the programming of the bending sequence.

REFERENCES

7.

In addition to the documents listed on page 2 under the heading *Main documents for consultation*, the following documents served as references for the authors.

BOURBONNIERE, R., PAQUES, J-J., MONETTE, C., DAIGLE, R. *Guide de conception des circuits de sécurité introduction aux catégories de la norme ISO 13849-1: 1999. R-405, IRSST, 2005, 73 p.* (www.irsst.qc.ca/files/documents/PubIRSST/R-405.pdf)

International Electrotechnical Commission. *Safety of machinery - Electro-sensitive protective equipment. General requirements and tests.* [Geneva] IEC/EN 61496-1, 2004.

International Electrotechnical Commission. *Safety of machinery - Electro-sensitive protective equipment. Particular requirements for equipment using active opto-electronic protective devices (AOPDs).* [Geneva] IEC/EN 61496-2, 2004.

International Electrotechnical Commission. *Safety of machinery - Application of protective equipment to detect the presence of persons.* [Geneva] IEC/EN 62046, 2008.

International Standard Organization. *Safety of machinery – Safety-related parts of control systems - Part 1: General principles for design.* [Geneva] ISO 13849-1: 2006, 2006.

International Standard Organization. *Safety of machinery - Interlocking devices associated with guards - Principles for design and selection.* [Geneva] ISO 14119: 1998, 1998.

International Standard Organization. *Safety of machinery – Guards - General requirements for the design and construction of fixed and movable guards.* [Geneva] ISO 14120: 2002, 2002.

LEMIEUX, G., CHINNIAH, Y., *Safeguarding of power press brakes using light curtains and laser beams.* In Proceedings of the 21st International Conference on Condition Monitoring and Diagnostic Engineering Management (COMADEM 2008), Czech Technical University, 11-12 June 2008: Prague, p. 293-307.

NGÔ, A.D., BEAUCHAMP, Y., LE-HUY, P. *La sécurité dans l'utilisation de machines dangereuses. Les presses-plieres dans le secteur de la fabrication d'équipement de transport et de machines.* École de technologie supérieure, 1998, 50 p.

8.

8.A Safety distance for safety light curtains and two-hand control device on a hydraulic power press brake

The safety distance is the distance that ensures that hazardous movement is stopped before the operator can reach the zone where this movement occurs. Furthermore, Canadian standard CSA Z142-02 (clause 10.4 and Appendix E) defines the safety distance as follows: distance calculated to be the minimum distance between the nearest pinch point and the safeguarding device in accordance with this Standard. This minimum distance on a hydraulic power press brake must be calculated using the following formula:

$$D_s = [K * (T_s + T_c + T_r)] + D_{pf}$$

where:

D_s = minimum safety distance

K = 1.6 m/s hand-speed constant (metres per second)

T_s = maximum machine stopping time

T_c = maximum control system stopping time

T_r = response time of the protective device

(T_r = 0 for two-hand control device)

D_{pf} = maximum penetration through the sensitive device before detection (see Appendix E of CSA Z142-02: D_{pf} = 0 for two-hand control device; D_{pf} = 1.2 m for horizontally configured safety light curtains; D_{pf} depends on the resolution for vertically configured curtains)

The value of the stopping time represented by the expression (T_s + T_c + T_r) must also be verified by measurements on the machine.

European standard EN 12622: 2001 specifies that the safety distance should not be less than 100 mm if the resolution is equal to or less than 14 mm. In the specific case of a vertically installed safety light curtain, a hand speed of 2 m/s must be used. If the safety distance is greater than 500 mm, the calculation can be repeated with a hand speed of 1.6 m/s. However, with this hand speed, the safety distance cannot be less than 500 mm.

Although Canadian standard CSA Z142-02 recommends a minimum hand speed of 1.6 m/s, with the trunk immobile, some studies¹ show that a higher speed should be considered.

8.B Stopping distance for laser beams

This is the distance covered by the ram from the moment when the stop signal is given by a means of detection (e.g., crossing a laser beam) or by a person until it completely stops.

The stopping distance must be measured on the machine.

¹ BÉLANGER, Raymond, Massé, Serge, Tellier, Chantal, Bourbonnière, Réal, Sirard, Christian, *Évaluation des risques associés à l'utilisation des presses à métal dans l'industrie québécoise*, R-085, IRSST, June 1994, p. 23.

8.C Reliability of the safety-related control system

Safety-related control circuits on a press brake must be designed and built in such a way that **a single failure or breakdown** in the system cannot prevent the normal stopping of the press when required, nor cause an unexpected cycle, but prevents new press cycles by the usual means until the failure is corrected.

Safety-related control circuits include:

- press cycle control circuits,
- initiation control circuits,
- electrical circuits that control the hydraulic valves,
- electronic circuits that ensure self-monitoring of the valves,
- other components of the control system that have an impact on the safeguarding of the working zone.

Information on the reliability of safety-related control systems:

- **CSA Z142-02**, *Code for Power Press Operation: Health, Safety, and Guarding Requirements*, **clause 8. Control reliability**.
- **NF EN 12622: 2001**, *Safety of machine tools – Hydraulic press brakes*.
- **IRSST R-405**, *Guide de conception des circuits de sécurité introduction aux catégories de la norme ISO 13849-1: 1999*.

8.D Reliability of the safety-related hydraulic system

Safety-related hydraulic circuits must have the same characteristics as those of safety related control circuits.

These circuits include:

- self-monitored directional valves,
- self-monitored safety valves,
- the other components of the hydraulic system.

