

Chemical Substances and Biological Agents

Studies and Research Projects

REPORT R-576



Analytical Evaluation of Dispersion of Exhaust from Rooftop Stacks on Buildings

*Ted Stathopoulos
Bodhisatta Hajra
Ali Bahloul*



Established in Québec since 1980, the Institut de recherche Robert-Sauvé en santé et en sécurité du travail (IRSST) is a scientific research organization known for the quality of its work and the expertise of its personnel.

OUR RESEARCH *is working for you !*

Mission

To contribute, through research, to the prevention of industrial accidents and occupational diseases as well as to the rehabilitation of affected workers.

To offer the laboratory services and expertise necessary for the activities of the public occupational health and safety prevention network.

To disseminate knowledge, and to act as scientific benchmark and expert.

Funded by the Commission de la santé et de la sécurité du travail, the IRSST has a board of directors made up of an equal number of employer and worker representatives.

To find out more

Visit our Web site for complete up-to-date information about the IRSST. All our publications can be downloaded at no charge.

www.irsst.qc.ca

To obtain the latest information on the research carried out or funded by the IRSST, subscribe to *Prévention au travail*, the free magazine published jointly by the IRSST and the CSST.

Subscription: 1-877-221-7046

Legal Deposit

Bibliothèque et Archives nationales

2008

ISBN: 978-2-89631-290-0 (print format)

ISBN: 978-2-89631-291-7 (PDF)

ISSN: 0820-8395

IRSST – Communications Division

505, De Maisonneuve Blvd West

Montréal (Québec)

H3A 3C2

Phone: 514 288-1551

Fax: 514 288-7636

publications@irsst.qc.ca

www.irsst.qc.ca

Institut de recherche Robert-Sauvé

en santé et en sécurité du travail,

September 2008

Chemical Substances and Biological Agents

Studies and Research Projects

REPORT R-576

Analytical Evaluation of Dispersion of Exhaust from Rooftop Stacks on Buildings

Disclaimer

The IRSST makes no guarantee regarding the accuracy, reliability or completeness of the information contained in this document. In no case shall the IRSST be held responsible for any physical or psychological injury or material damage resulting from the use of this information.

Note that the content of the documents is protected by Canadian intellectual property legislation.

*Ted Stathopoulos and Bodhisatta Hajra,
BCEE, Concordia University,*

Ali Bahloul, Research Department, IRSST

Clic Research
www.irsst.qc.ca



This publication is available free
of charge on the Web site.

IN CONFORMITY WITH THE IRSST'S POLICIES

The results of the research work published
in this document have been peer-reviewed.

Abstract

Dispersion is used here to describe the way in which effluent from stacks or other building exhaust is transported and diluted by the wind as it passes across the proposed development and immediate neighbors. Extreme air pollution occurs when air pollution reaches excessively high levels for several hours or several days and can cause severe discomfort, diseases and even deaths among the most vulnerable people. Extreme pollution has a high probability of occurrence when there are persistent thermal inversions and weak or stagnant winds due to which effluents cannot be dispersed.

Atmospheric dispersion modeling is the mathematical simulation of how air pollutants disperse in the ambient atmosphere. Such modeling is performed with computer programs that solve the mathematical equations and algorithms which simulate the pollutant dispersion. The dispersion models are used to estimate or predict the downwind concentration of air pollutants emitted from sources such as industrial plants and vehicular traffic. Such models are important to governmental agencies tasked with protecting and managing the ambient air quality. In particular, the health of workers in laboratory and hospital buildings is at great risk when pollutants generated by the activities in these buildings are reingested through air-conditioning inlets or open windows. The models are typically employed to determine whether existing or proposed new industrial facilities are or will be in compliance with the National Ambient Air Quality Standards (NAAQS) in the United States and other countries. The models also serve to assist in the design of effective control strategies to reduce emissions of harmful air pollutants.

This report investigates the use of the various air-dispersion models, which have been approved by the Environmental Protection Agency (EPA), in modeling dispersion of effluents from stacks located on roof tops to determine their concentrations at various areas of the roofs with these stacks. In this context the effects of roof top structures and the varying directions of wind have been taken into account. Comparisons of the wind tunnel and field data with the results obtained from various dispersion models were made. It was observed that the EPA models, which mostly use the Gaussian equations, are more appropriate for longer rather than shorter distances within the vicinity of the building under consideration. In such cases of proximity of the stack with the points of interest on the roof, the ASHRAE model and wind tunnel data can be more reliable, to predict dispersion or concentration of pollutants.

Contents

| | |
|---|------|
| Abstract..... | i |
| Contents | iii |
| List of Figures..... | v |
| List of Tables | vii |
| LIST OF SYMBOLS | viii |
| Chapter-1..... | 1 |
| Introduction..... | 1 |
| 1.1 General..... | 1 |
| 1.2 Definition of Dispersion | 1 |
| 1.3 Gaussian Plume Model | 2 |
| 1.4 Objectives of the Project..... | 4 |
| Chapter-2..... | 5 |
| Literature Review..... | 5 |
| 2.1 General..... | 5 |
| 2.2 Past Models..... | 5 |
| 2.3 Literature Involving Wind Tunnel and Field Data | 6 |
| 2.4 Literature Involving Application of EPA Models | 7 |
| 2.5 Research Based on Numerical Modelling..... | 8 |
| Chapter-3..... | 9 |
| Dispersion Models | 9 |
| 3.1 General..... | 9 |
| 3.2 Gaussian Air Pollutant Dispersion Equations..... | 9 |
| 3.3 ASHRAE Dispersion Model..... | 10 |
| 3.3.1 ASHRAE Geometric Design Method..... | 10 |
| 3.3.2 Dilution and Concentration..... | 12 |
| 3.4 ASHRAE 2007 Model | 15 |
| 3.5 U.S Environmental Protection Agency..... | 16 |
| 3.5.1 Preferred and Recommended Models..... | 16 |
| 3.5.2 Alternative Models..... | 17 |
| 3.5.3 Screening Models..... | 18 |
| 3.5.4 Photochemical Models..... | 18 |
| 3.5.5 Models Developed in other Countries | 18 |
| 3.6 Models Used in the Study | 18 |
| 3.6.1 ADMS 3.3 | 19 |
| 3.6.2 SCREEN 3 | 19 |
| 3.6.3 AFTOX | 20 |
| 3.6.4 ALOHA..... | 20 |
| Chapter-4..... | 21 |
| Wind Tunnel Experimentation..... | 21 |
| 4.1 General..... | 21 |
| 4.2 Boundary Layer Wind Tunnel and Instrumentation..... | 21 |

| | |
|---|----|
| Chapter-5..... | 27 |
| Results and Discussion | 27 |
| 5.1 General..... | 27 |
| 5.2 Case 1: Low-rise Building | 27 |
| 5.3 Case 2: High-rise Building..... | 34 |
| 5.5 Case 4: Low-rise Building with Varying Wind Direction | 44 |
| 5.6 Case 5: Field Data Comparison with ADMS 3.3..... | 49 |
| Chapter-6..... | 55 |
| Conclusions and Future Scope..... | 55 |
| 6.1 General..... | 55 |
| 6.2 Conclusions..... | 55 |
| REFERENCES | 59 |
| APPENDIX A..... | 63 |
| APPENDIX B..... | 67 |
| APPENDIX C..... | 69 |
| APPENDIX D..... | 71 |

List of Figures

| Figure Number | Title of Figures | Page Number |
|----------------------|--|--------------------|
| 1.1 | Gaussian plume model | 3 |
| 3.1 | Design procedure for stack height to avoid contamination | 11 |
| 3.2 | Flow recirculation regions and exhaust to intake distance | 15 |
| 3.3 | Flow recirculation regions and exhaust to intake distance | 16 |
| 4.1 | Front view of Boundary Layer Wind tunnel at Concordia University | 22 |
| 4.2 | Plan & Elevation of Boundary Layer Wind tunnel at Concordia | 22 |
| 4.3 | Building model representing a 15 m tall building | 24 |
| 4.4 | Velocity and turbulence intensity profile | 25 |
| 4.5 | Tracer Gas Experiment System | 26 |
| 5.1 | Low-rise building with stack and receptor location | 28 |
| 5.2 | Normalised dilution for a stack height of one meter | 29 |
| 5.3 | Normalised dilution for a stack height of two meters | 30 |
| 5.4 | Normalised dilution for a stack height of three meters | 31 |
| 5.5 | Normalised dilution for a stack height of five meters | 32 |
| 5.6 | Normalised dilution for a stack height of seven meters | 33 |
| 5.7 | High-rise building with stack and receptor location | 34 |
| 5.8 | Normalised dilution for a stack height of one meter | 35 |
| 5.9 | Normalised dilution for a stack height of three meters | 36 |
| 5.10 | Normalised dilution for a stack height of five meters | 37 |
| 5.11 | Normalised dilution for a stack height of seven meters | 38 |

| | | |
|------|--|----|
| 5.12 | Low-rise building with roof top structure | 40 |
| 5.13 | Normalised dilution for a stack height of one meter | 41 |
| 5.14 | Normalised dilution for a stack height of three meters | 42 |
| 5.15 | Normalised dilution for a stack height of five meters | 43 |
| 5.16 | Normalised dilution for a stack height of seven meters | 44 |
| 5.17 | Low-rise building with wind angle at 45 degrees | 45 |
| 5.18 | Normalised dilution for a stack height of one meter | 46 |
| 5.19 | Normalised dilution for a stack height of three meters | 47 |
| 5.20 | Normalised dilution for a stack height of five meters | 48 |
| 5.21 | Normalised dilution for a stack height of seven meters | 49 |
| 5.22 | BE and FG buildings with stack and receptor locations | 50 |
| 5.23 | Normalised dilution for a stack height of one meter | 51 |
| 5.24 | BE and FG buildings with stack and receptor locations | 52 |
| 5.25 | Normalised dilution for a stack height of one meter | 53 |
| A 1 | Grid for low-rise building | 63 |
| A 2 | Contour plot for low-rise building with 3 m stack | 64 |
| A 3 | Grid for low-rise building | 65 |
| A 4 | Contour plot for low-rise building | 66 |
| B 1 | Input Screen for SCREEN 3 software | 67 |
| C 1 | Input-Output screen for AFTOX | 69 |
| D 1 | Input and output for ALOHA 5.4 | 71 |

List of Tables

| Table Number | Title of Tables | Page Number |
|-------------------------|------------------------------|------------------------|
| 5.1 | Low-rise building details | 39 |
| 5.2 | Roof top structure details | 39 |
| 5.3 | Low-rise building details | 45 |
| 6.1 | Summary of dispersion models | 57 |

LIST OF SYMBOLS

| Symbol | Definition | Units |
|------------------|---|-----------|
| A_e | Stack area | m^2 |
| B_l | Distance dilution parameter | - |
| B_s | Smallest upwind distance | m |
| B_L | Largest upwind distance | m |
| C | Contaminant concentration at receptor | lb/ft^3 |
| C_{allow} | Allowable concentration | lb/ft^3 |
| C_{max} | Maximum concentration at the receptor | lb/ft^3 |
| C_e | Exhaust concentration | lb/ft^3 |
| D | Dilution | - |
| D_{min} | Minimum dilution, ASHRAE (2003) | - |
| D_o | Initial dilution | - |
| D_d | Distance dilution | - |
| D_r | Dilution at roof level | - |
| D_{req} | Required dilution | - |
| D_V | Volume concentration dilution factor | - |
| $D_{normalised}$ | Normalised dilution | -x |
| d_s | Stack diameter | m |
| f | Contaminant volume fraction at the receptor | - |
| f_e | Pollutant volume fraction | - |
| h_d | Reduction in plume height | m |
| h_{plume} | Height of plume | m |
| h_r | Plume rise | m |
| h_s | Stack height | m |
| h_{small} | Smallest plume height | m |
| h_{top} | Height of critical recirculation zone | m |
| h | Effective plume height | m |
| H | Total height of release | m |
| H_c | Maximum height of the roof recirculation zone | m |
| k | Normalised dilution | - |
| L_c | Length of the roof recirculation zone | m |
| L_r | Length of the building wake zone | m |
| m | Contaminant mass release rate | lb/s |
| M | Exhaust momentum (V_e / U_H) | - |
| P_{max} | Maximum concentration of pollutants | - |
| $q(x, y, z)$ | concentration of effluents at any receptor | m |
| Q_{SF6} | Sulphur hexafluoride flow rate | m^3/s |
| R | Scaling length | m |
| S | Stretched string distance | m |
| t_{avg} | Averaging time | minutes |
| T_e | Exhaust air absolute temperature | K |

| | | |
|------------|---|-----|
| T_a | Outside ambient air absolute temperature | K |
| U_H | Wind velocity at building height | m/s |
| V_e | Exhaust velocity | m/s |
| σ_o | Initial source size that accounts for stack diameter and dilution jet entrainment during plume rise | m |
| σ_y | Diffusion coefficient (horizontal direction) | m |
| σ_z | Diffusion coefficient (vertical direction) | m |
| α | Parameter which depends on building shape and exhaust momentum | - |
| β | Stack capping factor | - |
| ζ | Vertical separation above h_{top} | m |
| X_c | Distance from the leading edge to H_c | m |
| Z_1 | Roof recirculation zone | - |
| Z_2 | High turbulence region | - |
| Z_3 | Roof wake boundary | - |

Chapter-1

Introduction

1.1 General

One of the major causes of poor indoor air quality at some facilities is the occurrence of exhaust reingestion at fresh air intakes. It is therefore extremely important to design the intake and exhaust system so that the effluents which leave the building do not re enter. University, hospital and industrial laboratories are some of the places where effluents may be toxic and dangerous, whereas the health of workers and a clean environment are essential. Unfortunately, the state-of-the-art has not been sufficiently advanced to allow building engineers to apply appropriate design criteria to avoid this problem for new construction or to help alleviate it for existing buildings.

There have been many projects carried out jointly by the Institut de recherche Robert-Sauvé en santé et en sécurité du travail (IR SST) and Concordia University, Canada. This report summarizes some previous results obtained experimentally in the wind tunnel and also in the field. Recently there have been numerous dispersion models developed by several institutions. Most noteworthy are those developed by the EPA (Environmental Protection Agency), USA. EPA is one of the governing bodies in the field of dispersion of pollutants and air quality in the open, urban or in the building environment. Some of the models developed in other countries have also been accepted by the EPA.

1.2 Definition of Dispersion

As an effluent plume is transported from the source, turbulent eddies within the plume diffuse the effluent. The combined influences of diffusion and transport are generally called dispersion. A concentration gradient exists in the effluent, so that the effluent concentrations in the centre of the plume are larger than those toward the plume edges. As the plume moves with the wind, diffusion continues in the upward vertical direction to the mixing height, generally ranging from about 200 to 2000 meters above the surface of the earth. Within this atmospheric mixing layer, turbulence exists and facilitates the mixing of the effluent. At the top of the mixing layer turbulence is decreased and above this "boundary", further vertical diffusion can be significantly reduced. Though the phenomenon of diffusion also exists in lateral and longitudinal directions, the latter is small compared to convection and dispersion by wind shear. However lateral dispersion and meandering are significant.

There are two main types of turbulence within the mixing layer: mechanical turbulence caused by ground surface effects, and thermal turbulence caused by heating and cooling of the earth's surface. Mechanical turbulence not only results from the frictional drag of the earth's surface and increases in proportion to the wind speed and the roughness of the underlying surface but also through separation and reattachment as well as eddy shedding by bluff bodies and other objects. Within the mixing layer, wind speed tends to increase with height because of reduced friction between the air and the earth's surface. In heavily built up such as urban areas, wind speed increases with height at a slower rate than in areas where the terrain is less rough, such as the suburbs, or in level country.

Thermal turbulence depends on the stability of the atmosphere within the mixing layer. Atmospheric conditions within the mixing layer are unstable, stable, or neutral depending on conditions that promote, retard, or have no effect on the movement of air particles from one location to another. Assuming that a parcel of air (and the particles within it) is set in motion so that it either rises or falls, further movement depends on the temperature of the parcel of air relative to that of the surrounding atmosphere into which it moves:

- *Unstable conditions : air particle vertical movement is promoted.* If an initially rising parcel of air is warmer than the surrounding atmosphere, it is more buoyant than the surrounding atmosphere and continues to rise. However, if an initially falling parcel of air is cooler than the surrounding atmosphere, it becomes denser than the surrounding atmosphere, and therefore less buoyant. It continues to sink. In either case, vertical air particle movement is promoted.

- *Stable conditions : air particle vertical movement is retarded.* If an initially rising parcel of air is cooler than the surrounding atmosphere, it becomes denser than the surrounding atmosphere, and sinks. But if an initially falling parcel of air is warmer than the surrounding atmosphere, it becomes more buoyant than the surrounding atmosphere, and rises. In either case, air particle vertical movement is retarded.

- *Neutral conditions.* If a rising or falling parcel of air is at the same temperature as the surrounding atmosphere, then movement of air particles is neither promoted nor retarded by buoyancy forces.

Different atmospheric stability conditions can strongly affect the dispersion of effluents. For example, under stable conditions and with little change of wind direction, a plume of effluent from a stack can retain a narrow shape in the vertical direction for a long distance downwind. On the other hand unstable conditions can result in a looping plume, and the effluent released from a stack can contact the ground relatively close to the release point.

1.3 Gaussian Plume Model

One of the most widely used models for numerically describing the movement and dispersion of effluent from a release point is the Gaussian plume model. Figure 1.1 (from “Air Pollution” by Jeremy Colls, 2002) shows a simplified form of a Gaussian plume model, showing contaminants released from a stack.

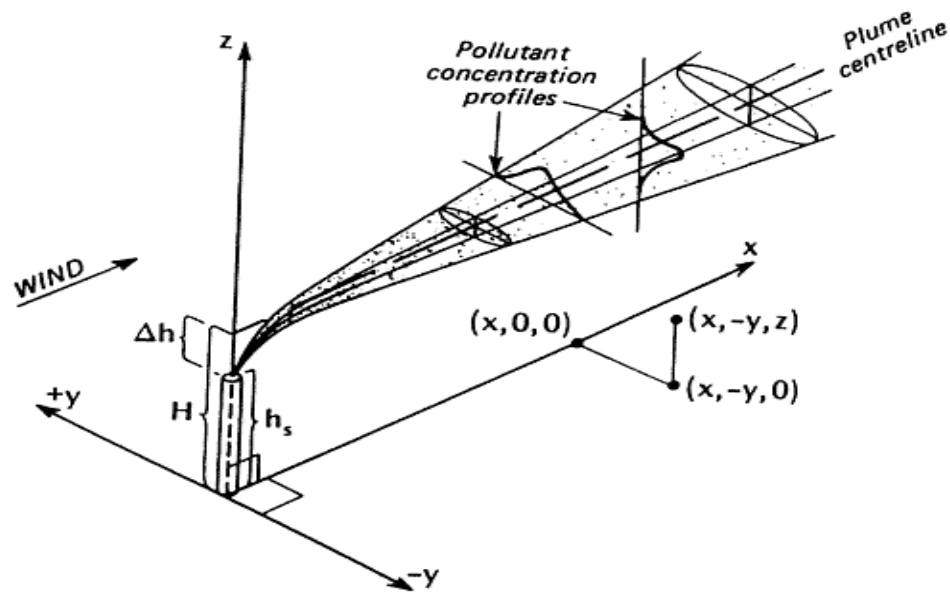

Figure 1.1 Gaussian Plume model (from “Air Pollution” by Jeremy Colls, 2002, page 281)

Actually a Gaussian plume model implies that a normal statistical distribution is used to describe the spread of an effluent in the various coordinate directions. The choice of a normal distribution is simply statistically convenient, and there are other statistical distributions that are also satisfactory, and, in fact, may be physically preferable since they do not imply instantaneous transport of effluent to infinite distances. The main advantage of such analytic expressions is their mathematical simplicity given the actual uncertainty associated with any prediction. The Gaussian plume model accounts for the downward movement as well as the vertical and horizontal dispersion of the released contaminants, and predicts contaminant concentrations on the ground and in the air. The figure depicts Gaussian (normal) distributions in the vertical and crosswind directions. Near the point of release, the concentration is high near the centreline and falls off rapidly toward the edges. But further downstream, the distribution of concentration spreads from the centreline.

The shapes of the concentration distributions are described in the Gaussian plume model by parameters known as diffusion coefficients. Assuming that diffusion along the direction of the wind is small compared to transport by wind, the Gaussian plume model incorporates two diffusion coefficients, σ_y and σ_z . These are the standard deviations of the Gaussian distributions in the crosswind (horizontal) (σ_y) and vertical (σ_z) directions.

Many systems have been used to estimate diffusion coefficients. Most of the systems have been based on atmospheric stability classes and the distance from the source. These atmospheric classes are linked to the three atmospheric stability conditions (neutral, stable and unstable). The commonly used system is the Pasquill (1966) and Gifford (1966), which use a set of equations that approximate a corresponding set of empirically-

determined curves. The curves provide σ_y and σ_z values as a function of the distance from a source for six stability classes.

1.4 Objectives of the Project

The present research activity is based on statistical analysis of the experimental results and analytical evaluations of various models proposed by ASHRAE and others available in the literature. The performance of those dispersion models have been examined with the help of full-scale and wind tunnel experimental data originated from tracer gas measurements of exhaust from a movable roof top stack on the roof of a low-rise building in urban environment. The experimental data obtained from the cooperative study (extensive field tests and wind tunnel experiments) carried out by Concordia University and IRSST researchers in the last several years have been used in the present study.

The major goals of the present activity are to evaluate dilution models (ASHRAE, UK ADMS, AFTOX, ALOHA, SCREEN 3) that have recently been adopted by several organisations and to provide guidelines for reducing the risk of exhaust reingestion at fresh air intakes. The results will help reduce potential exhaust reingestion, due to the flow recirculation around buildings, at fresh air intakes and improve the indoor air quality for workers in laboratories, factories, hospitals and other industrial buildings.

The report has been divided into five chapters. Following the introduction, Chapter-2 deals with literature review and discusses the research carried out in the fields of dispersion. This is followed by the chapters on dispersion models and wind tunnel experimentation wherein various models available in the open literature have been presented in detail along with a brief overview of the specific models that have been used in the present study and details about the experimental work and facilities available at Concordia University are provided. A graphical representation of the results accompanied by an in-depth discussion has been presented in Chapter-5. Based on the study and calculations, several conclusions have been drawn, which have been incorporated in Chapter-6.

Chapter-2

Literature Review

2.1 General

Fresh air enters a building through its air intake(s). Likewise, building exhausts remove air contaminants from a building so that wind can dilute the emissions. If the intake or exhaust system is not well designed, contaminants from nearby outside sources (e.g., vehicle exhaust) or from the building itself (e.g., laboratory fume hood exhaust) can enter the building with insufficient dilution. Poorly diluted contaminants may cause odours, health impacts, and reduced indoor air quality. Therefore, it is extremely important to study and understand the effects of dilution especially for shorter distances involving the building and its nearby vicinity. This chapter focuses on some of the literature pertaining to conventional dispersion models, wind tunnel study, ASHRAE recommendations and dispersion models that are approved by the EPA.

2.2 Past Models

Based on wind tunnel experimentation, Halitsky (1963) formulated the following equation for minimum dilution:

$$D_{\min} = [\alpha + 0.11(1 + 0.2 \alpha) S/A_e^{0.5}]^2 \quad (2.1)$$

Where “S” is the distance from the source, “A_e” is the exhaust area and “α” is the parameter that depends on building shape, momentum ratio and building orientation, which is dimensionless; hence equation 2.1 is also dimensionless.

Scorer (1968) developed a model in which a plume was represented by means of a cone, the angle of which was used to denote the rate of dispersion. He suggested that if the plume had a circular cross section of radius “R”, with “U” as wind speed and “Q” as emission rate of pollutants, then by evaluating a complex set of integrals, the maximum concentration of pollutants (P_{max}), would be:

$$P_{\max} = Q / (\pi R^2 U (0.5 - 2 / \pi^2)) \quad (2.2)$$

Meroney (1982) developed a method suitable for interpolating between the cases of aerodynamic downwash and full cavity entrainment situation. He devised a formula for determining the desired concentration coefficient from the actual effective stack height. These formulations were based on several experimental results obtained from the wind tunnel.

Three of the most widely developed models include the Wilson and Chui (1985, 1987), Wilson and Lamb (1994) and Halitsky (1963) of which the latter two are also a part of the ASHRAE Fundamentals Handbook (1997).

The Wilson-Chui model was developed by performing extensive wind tunnel experimentation on isolated buildings. Wilson and Chui (1985, 1987) suggested the following expression for the minimum dilution along the plume centre line:

$$D_{\min} = (D_o^{0.5} + D_d^{0.5})^2 \quad (2.3)$$

where “ D_0 ” is the initial dilution at the exhaust location and “ D_d ” is the distance dilution which is produced by atmospheric and building generated turbulence. The ASHRAE (1993) formulations have also been derived from the above expressions. There is generally no factor of safety built into the Wilson models, but the ASHRAE 1974 expression based on Halitsky’s 1963 data provides about an order of magnitude safety factor. This could be considered good or bad depending on the safety v/s fiscal implications of the differences.

Wilson and Lamb (1994) proposed a revised version of the D_{\min} model that has been included in ASHRAE 1997. This model takes care of the effect of upstream turbulence on the distance dilution parameter.

2.3 Literature Involving Wind Tunnel and Field Data

Li and Meroney (1983) performed wind tunnel experiments on a building model to assess the effluent concentration in the near-wake region ($x/H < 5$). A full-scale measurement was conducted in the near-wake region for central roof vent release. The study found that the concentration of the effluents reduced by the presence of a sharp edge on the model. It was further found that when the building was oriented to an angle of 45 degrees to the wind, a secondary peak concentration resulted in the near-wake region. Indeed, orientation other than normal to the wind can increase concentration by factors of two or more as a result of enhanced plume downwash.

Schulman and Scire (1991) carried out a wind tunnel study to investigate the influence of stack height and exit velocity on the dispersion of emissions from a roof top stack. The experiments were performed with an isolated low-rise building with a stack in the centre of the roof. The results are given for a typical exhaust velocity, expressed in terms of the exhaust momentum ratio, $M=V_e/U_H$. In this case, $M=3$, which is generally associated with moderately strong winds. The results show that increasing h_s from 0 to 4.6 m causes concentration to reduce by a factor of 100 near the stack. However, at the leeward edge of the building, the increase in stack height produces only a marginal benefit.

Martin (1965) measured plume dilution at ground level locations downwind of a nuclear reactor at the University of Michigan and compared them to the wind tunnel results. He found that when the plume is affected by building downwash, mean field concentrations compared well with mean concentrations measured in wind tunnel, however in the absence of building downwash effects, the field results matched with the average concentrations in the wind tunnel. This work was the first really good comparison of dispersion around a building in a boundary layer wind tunnel against field data because most of the earlier works by Halitsky (1963) were in a uniform flow tunnel.

Saathoff et al. (1996) compared wind tunnel and field data in the WSU field study (Lamb and Cronn (1986)). It was found that the wind tunnel values compared well with the field data. Dilution measurements at the receptor locations were within a factor of two of the field data.

Higson et al. (1994) conducted field tracer gas experiments with a stack at varying distances upwind of a small movable building and compared the results with wind tunnel data. They found that the maximum concentrations were generally overestimated in the wind tunnel tests; the minimum concentrations were underestimated. This suggests that the wind tunnel plume was narrower than the field plume due to the absence of large scale turbulence in the wind tunnel.

Meroney et al. (1999) evaluated dispersion and flow patterns around various building shapes using wind tunnel experiments. Flow visualization experiments demonstrated that flow recirculation zones are intermittent and consequently, the direction of flow at a roof top location may change frequently from upwind to downwind. The authors suggest that the inaccuracy of CFD dispersion predictions is due, in part, to the absence of intermittency in the computer model.

2.4 Literature Involving Application of EPA Models

Carruthers et al (2004) carried out a comparative study between the FLUENT and ADMS software. It was observed that when FLUENT was set up to simulate the neutrally stable atmospheric boundary layer, the mean velocity profiles were well predicted and were maintained with downwind distance. The algebraic Reynolds stress turbulence model provided the best predictions for the turbulence kinetic energy (TKE) and dissipation. Overall, the CFD simulations with the Lagrangian particle method were satisfactory; however, they could not be considered as an appropriate alternative to a model such as ADMS for normal atmospheric dispersion studies because of the much larger run times and the greater complexity of setting up model runs. CFD is more appropriate for applications that involve complex geometry that could not be simulated using ADMS.

Petersen et al (2000) compared the ISC3 and wind tunnel results. The statistical evaluation showed that ISC3 tends to over predict and PRIME tends to under predict results when compared to the wind tunnel observed concentrations. The study also showed that both models agree well with wind tunnel observations for certain building arrangements and show less favourable agreement in other cases. Although the PRIME model is vastly superior to the ISC3 model from a theoretical standpoint, the results of this study show that further improvements can be made.

Dunkerley et al (2000) compared the AERMOD, ADMS and ISC models and concluded that these models use different methods to account for the effect of terrain on dispersion which generate correspondingly diverse results. Air Quality guidelines and standards are often formulated in terms of percentile statistics. The implication of the model results for regulatory purposes is that the location and value of the maximum concentrations predicted by each of the models over a given period is likely to be significantly different. This is borne out by comparative calculations for a whole single year.

Wang et al (2006) compared the ISCST3 and CALPUFF models. The comparisons between predicted and field sampled downwind concentrations indicate that the CALPUFF model could fairly well predict average downwind odour concentrations. However, ISCST3 tended to under predict downwind odour concentrations as compared

to the measured concentrations. Both the CALPUFF and ISCST3 models failed to predict peak odour concentrations using the constant average emission rate. Odour emission rates obtained by back-calculating fluxes using CALPUFF and ISC models with the same field measurements of downwind odour concentrations are significantly different.

2.5 Research Based on Numerical Modelling

Stathopoulos et al (1998) carried out numerical simulation of air pollutant dispersion around cubic and rectangular buildings by using the standard $k-\epsilon$ turbulence model. Results have been compared with experimental data and past numerical simulation results. The influence of convergence criteria to the numerical solution has been investigated and the discretization error has been estimated by using two different grid systems. It was found that the discretization errors were less than 15% for the ground-level dispersion of the case investigated.

Quinn et al (2001) have modelled the dispersion of aerial pollutants from agricultural buildings by using computational fluid dynamics (CFD). The dispersion of a point source of ammonia gas in the wake of a low-rise building has been predicted using a simple scalar (diffusion) model. These models were used in conjunction with flow field data from a CFD model using the standard and a modified $k-\epsilon$ turbulence models. The authors suggest that explicit modelling of wind direction fluctuations is essential to dispersion models of this type. Turbulence modelling has a significant effect on the predicted concentration field in the wake of buildings and until improvements in this modelling are made the dispersion model used is of less significance.

Ahmadi et al (2007) have performed computer simulation of particle transport and deposition near a small isolated building. They have concluded that the computer simulation procedure provides a viable method for studying particle transport and deposition processes near buildings. If near and behind a building, the turbulence is strongly anisotropic, turbulence dispersion is the dominating mechanism for particle spreading in the vicinity of buildings. It was also found that impaction is the dominant mechanism for deposition of particles larger than 15 μm . The gravitational sedimentation effect increases the deposition rate on downstream ground for particles larger than 10 μm .

Chapter-3

Dispersion Models

3.1 General

Air pollutants which disperse in the atmosphere are simulated mathematically by using computer programs developed by various individuals/organisations. This technique of simulating pollutant transports by the use of computers is called dispersion modelling. With the availability of high-speed computers development of such models has been possible. These models are useful in assessing the concentration of effluents which are discharged from stacks located on building or from isolated stacks.

Dispersion models require certain input based on which pollutant concentration can be determined. This is extremely important, especially for a designer in order to determine the location of stack and intake on roof top of buildings. Such input include meteorological conditions, i.e. wind speed and direction, emission parameters, e.g. mass flow rate of effluents and stack diameter, location of receptor and stack and the dimensions of the building and roof top structure under consideration.

In this context, only few models are relevant and suitable for the cases considered and have been elucidated in this report given that the majority of models are suited for far-field dispersion problems. Since most models make use of the popular “Gaussian equations”, it becomes necessary to describe them in more detail in the following section.

3.2 Gaussian Air Pollutant Dispersion Equations

In the early 1930s Bosanquet and Peterson derived plume dispersion equations which did not assume a Gaussian distribution (Bosanquet et al, 1936). Later Sir Graham Sutton derived pollutant dispersion equation which assumed Gaussian distribution in the vertical and crosswind dispersion of the plume (Sutton, 1947). In the Gaussian method, an instantaneous release of a pollutant from a point source is considered. This pollutant moves downwind in the along wind direction and progressively expands in volume, incorporating air from around it and reducing its concentration. Therefore, the concentration of the effluent is maximum at the point of release, and reduces gradually in both positive and negative directions, thus forming a “Gaussian bell-shaped distribution”, as shown in figure 1.1.

The Gaussian equations can be stated as follows:

$$q(x, y, z) = \frac{Q}{2\pi\bar{u}\sigma_y\sigma_z} \exp\left\{-\frac{y^2}{2\sigma_y^2}\right\} \left\{ \exp\left\{-\frac{(z-H)^2}{2\sigma_z^2}\right\} + \exp\left\{-\frac{(z+H)^2}{2\sigma_z^2}\right\} \right\} \quad (3.1)$$

where

σ_y and σ_z are the standard deviations in the y and z directions, respectively; and H is the total height of release.

Q is the emission rate of exhaust released from stack in kg/s

x , y and z represent the coordinate directions (see figure 1.1)
 $q(x, y, z)$ represents the concentration of effluents at any receptor located at x meters downwind, y meters crosswind and z meters above the ground.

3.3 ASHRAE Dispersion Model

Various models have been developed for estimating near field dilution of plumes emitted from roof top stacks for open fetch situations. Two such models are recommended in ASHRAE (1999) and ASHRAE (2003) and are described below. Recently, ASHRAE has also published the 2007 version with some changes from the previous edition. The accuracy of these models will be evaluated in Chapter 5 using wind tunnel data and some of the common dispersion models approved by the EPA.

For the case of a tall building upwind of an emitting building, dilution estimates are required for receptors on the adjacent building leeward wall, as well as the roof of the emitting building. To date, no acceptable dilution model for this case has been developed [e.g. see Wilson et al. (1998)]. In addition to dilution models that provide quantitative estimates of plume dispersion, ASHRAE (2003) also provides a geometric method to predict the likelihood of a plume making contact with a critical roof top receptor. This method, which is qualitative in nature, is described below.

3.3.1 ASHRAE Geometric Design Method

ASHRAE (2003) provides a geometric stack design method for estimating the minimum stack height to avoid plume entrainment in the flow recirculation zones of a building and its roof top structures. Dimensions of the recirculation zones are expressed in terms of the scaling length, R , which is defined as:

$$R = B_s^{0.67} B_L^{0.33} \quad (3.2)$$

where

B_s is the smaller of upwind building height or width and B_L is the larger of these dimensions. The dimensions of flow re-circulation zones that form on the building and roof top structures are:

$$H_c = 0.22R \quad (3.3)$$

$$X_c = 0.5R \quad (3.4)$$

$$L_c = 0.9R \quad (3.5)$$

where H_c is the maximum height of the roof recirculation zone,

X_c is the distance from the leading edge to H_c ,

L_c is the length of the roof recirculation zone; and

L_r is the length of the building wake zone.

Figure 3.1 shows the recirculation zones for a typical building. Note that the height of the wake zone is equal to the height of the building.

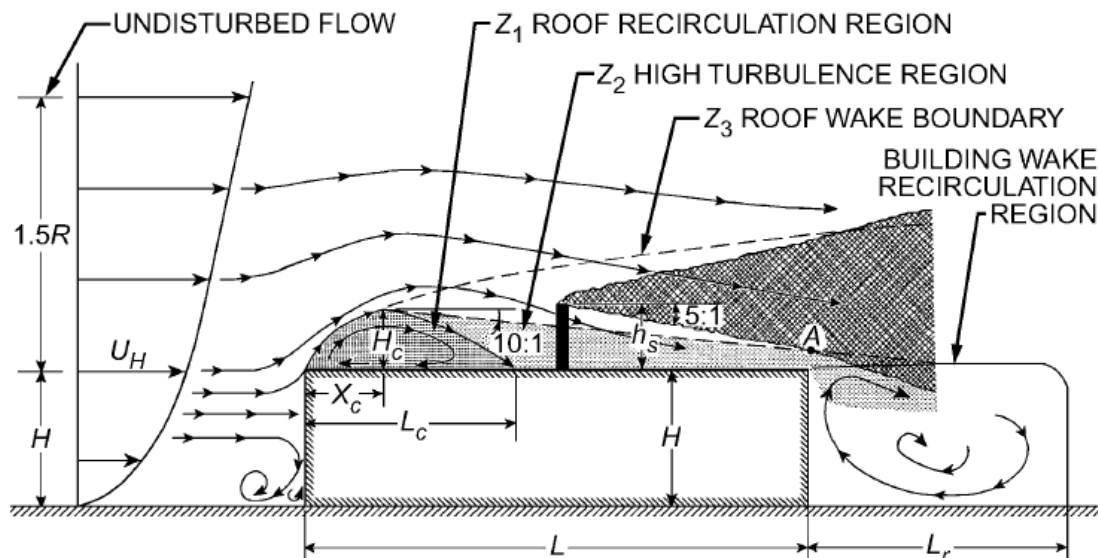

Figure 3.1 Design procedure for required stack height to avoid contamination [from Wilson (1979)]

The geometric design method assumes that the boundary of the high turbulence region is defined by a line with a slope of 10:1 extending downward from the top of the leading edge separation bubble. The location of the plume relative to the recirculation zones is determined by taking into account plume rise due to exhaust momentum and assuming a conical plume with a slope of 5:1.

The effective height of the plume above the roof or roof top structure is:

$$h = h_s + h_r - h_d \quad (3.6)$$

where

h_s is stack height,

h_r is plume rise and

h_d is the reduction in plume height due to entrainment into the stack wake during periods of strong winds.

It should be noted that h_s is the height of the stack tip above the roof minus the height of roof top obstacles (including their recirculation zones) that are in the path of the plume (Figure 3.1). Plume rise, which is assumed to occur instantaneously, is calculated using the formula of Briggs (1984):

$$h_r = 3\beta d_e (V_e/U_H) \quad (3.7)$$

where d_e is the stack diameter,

V_e is the exhaust velocity,

U_H is the wind speed at building height

and β is the stack capping factor. The value of β is 1 for uncapped stacks and 0 for capped stacks. It is worth noting that these calculations presume a round or circular stack. In fact

rectangular stacks are also used. Franck and Jensen (1963) found that rectangular stacks with broad side to the wind caused significant stack downwash. In some cases groups of round stacks are brought together to enhance the effects of buoyancy on plume rise.

To account for the stack downwash caused by low exit velocities, when $V_e/U_H < 3.0$, Wilson et al. (1998) recommended a stack wake downwash adjustment h_d , which is defined as:

$$h_d = d_e(3.0 - \beta V_e/U_H) \quad (3.8)$$

For $V_e/U_H > 3.0$ there is no stack downwash ($h_d = 0$).

3.3.2 Dilution and Concentration

A building exhaust system releases a mixture of building air and pollutant gas at concentration C_e (mass of pollutant per volume of air) into the atmosphere through a stack or vent on the building. The exhaust mixes with atmospheric air to produce a pollutant concentration C , which may contaminate an air intake or receptor if the concentration is larger than some specified allowable value C_{allow} ($C_{allow} = 0$ for carcinogenic materials). The dilution factor D between source and receptor mass concentrations is defined as:

$$D = C_e / C \quad (3.9)$$

where

C_e = contaminant mass concentration in exhaust, lb/ft³

C = contaminant mass concentration at receptor, lb/ft³

NB: Even though the concentrations mentioned in ASHRAE are in lb/ft³, however in this study the concentrations of effluents have been found in µg/m³ and since the results have been expressed as dilutions, so the net results are dimensionless.

The dilution increases with distance from the source, starting from its initial value of unity. If C is replaced by C_{allow} in Equation (3.9), the atmospheric dilution required to meet the allowable concentration at the intake (receptor) is:

$$D_{req} = C_e / C_{allow} \quad (3.10)$$

The exhaust (source) concentration is given by

$$C_e = m/Q_e = m / (A_e V_e) \quad (3.11)$$

where

m = contaminant mass release rate, lb/s

$Q_e = A_e V_e$ = total exhaust volumetric flow rate, ft³/s

A_e = exhaust face area, ft²

V_e = exhaust face velocity, ft/s

The concentration units of mass per mixture volume are appropriate for gaseous pollutants, aerosols, dusts, and vapours. The concentration of gaseous pollutants is usually stated as a volume fraction f (contaminant volume/mixture volume), or as ppm (parts per million) if the volume fraction is multiplied by 10⁶. The pollutant volume fraction f_e in the exhaust is

$$f_e = Q/Q_e \quad (3.12)$$

where Q is the volumetric release rate of the contaminant gas.

Both Q and Q_e are calculated at exhaust temperature T_e .

The volume concentration dilution factor D_v is

$$D_v = f_e / f \quad (3.13)$$

where f is the contaminant volume fraction at the receptor. If the exhaust gas mixture has a relative molecular mass close to that of air, D_v may be calculated from the mass concentration dilution D by:

$$D_v = (T_e / T_a) D \quad (3.14)$$

where

T_e = exhaust air absolute temperature,

T_a = outside ambient air absolute temperature,

Many building exhausts are close enough to ambient temperature that volume fraction and mass concentration dilutions D_v and D are equal. This clarifies the difference between D_v and D , which is extremely important for cursory discussions. Contaminant dilution measured at an intake depends on the height h of the exhaust plume above the roof. Dilution at roof level D_r is inversely proportional to the volume flow rate of effluent from the stack, and directly proportional to the wind speed U_H that stretches the plume longitudinally in the x direction. Dilution at roof level in a Gaussian plume emitted at the final rise plume height of h is:

$$D_r = 4 \frac{U_H}{V_e} \frac{\sigma_y}{d_e} \frac{\sigma_z}{d_e} \exp\left[-\frac{h^2}{2\sigma_z^2}\right] \quad (3.15)$$

where

$$h = h_s + h_r - h_d \quad (3.16)$$

The plume rise h_r and stack wake downwash h_d are calculated from Equations (3.7) and (3.8). The stack height h_s in Equation (3.16) is the height of the stack tip above the roof, minus the height at the intake location of the roof top obstacles and recirculation zones. If exhaust gases are hot, buoyancy increases the rise of the exhaust gas mixture and produces lower concentrations (higher dilutions) at roof level. For all exhausts except very hot flue gases from combustion appliances, it is recommended that plume rise from buoyancy be neglected in dilution calculations and stack design on buildings.

By neglecting buoyant plume rise, Equation (3.15) for roof-level dilution D_r has an inherent safety factor, particularly at low wind speed, where buoyancy rise is significant. Equations for vertical and cross-wind spread were developed for non-buoyant exhaust jets from roof top stacks on flat-roofed buildings (Wilson et al. 1998). In the first 1000 ft downwind from the stack, both cross-wind plume spread σ_y and vertical plume spread σ_z increase almost linearly with distance x . The recommended equations for plume spreads are based on full-scale atmospheric measurements by McElroy and Pooler (1968) in an urban area, as used in the EPA (1995) model ISCST. The urban ISCST equations are adjusted here from the 60 min measured averaging time to 2 min averages with the 0.2 power law applied to both vertical and crosswind spreads. Then, the vertical spread over a building roof is assumed to remain constant at the 2 min averaging time value for longer averaging times. The plume equations are as follows:

$$\frac{\sigma_y}{d_e} = 0.071 \left(\frac{t_{\text{avg}}}{2.0} \right)^{0.2} \frac{X}{d_e} + \frac{\sigma_0}{d_e} \quad (3.17)$$

$$\frac{\sigma_z}{d_e} = 0.071 \frac{X}{d_e} + \frac{\sigma_0}{d_e} \quad (3.18)$$

where

t_{avg} is the concentration averaging time in minutes,

X is the distance downwind from the stack,

σ_0 is the initial source size that accounts for stack diameter and for dilution jet entrainment during plume rise.

The dependence of initial spread σ_0 on exit velocity to wind speed ratio V_e/U_H is

$$\frac{\sigma_0}{d_e} = \left[0.125\beta \frac{V_e}{U_H} + 0.911\beta \left(\frac{V_e}{U_H} \right)^2 + 0.250 \right]^{0.5} \quad (3.19)$$

where

β is the rain cap factor: $\beta = 1$ for no rain cap, and $\beta = 0$ if there is a rain cap. For $\beta = 0$, there is still an effective source size σ_0 equal to half the diameter d_e of the stack. The averaging time over which exhaust gas concentration exposures are measured is important in determining roof-level dilution. As averaging time increases, the exhaust gas plume meanders more from side to side, reducing the time-averaged concentration (and increasing the dilution) observed at an air intake location. The effect of changing the averaging time over a range of about 2 to 180 min can be estimated by adjusting the 2 min value of the cross-wind spread σ_y by the 0.2 power of the averaging time t_{avg} (Wollenweber and Panofsky 1989). This averaging time adjustment appears directly in Equation (3.17). If the exhaust and intake are both located in the same flow recirculation region, dilution is less sensitive to averaging time than predicted by the 0.2 power law.

Equations (3.17) and (3.18) apply only if the exhaust plume avoids all obstacles and flow recirculation zones between the stack and air intake. The procedure for calculating the smallest plume height h_{small} for which the dilution and plume rise equations are valid is similar to the geometric method for stack design. Accurate dilution calculations can only be made for plumes with combined stack height h_s , plume rise h_r , and downwash h_d in Equation (3.16) above this smallest height h_{small} . First the critical wind direction has to be determined on a plan view of the roof by drawing a line through the stack location and the intake at which dilution has been calculated. All obstacles upwind of the air intake location and within one obstacle width laterally of this critical wind direction line are active obstacles. To find h_{small} , one has to use the geometric-method plume height including only these active obstacles. Obstacles downwind of the air intake in question and the wake region downwind of the building need not be considered. After design calculations for dilution, and stack height h_s is chosen, the plume height h_{crit} at the critical design wind speed U_H must be compared to h_{small} to determine whether $h_{\text{crit}} > h_{\text{small}}$. If the proposed stack produces a plume height larger than h_{small} , the dilution calculation is valid.

If the plume height is less than h_{small} but higher than any roof top obstacle or roof top recirculation zone (h_{top} in Figure 3.2), then only the physical stack height above h_{top} should be used to compute plume height rather than the full physical stack height. Please note that h_{small} cannot be depicted on a picture, since it is just a definition given in ASHRAE 2003 and varies depending on the situation.

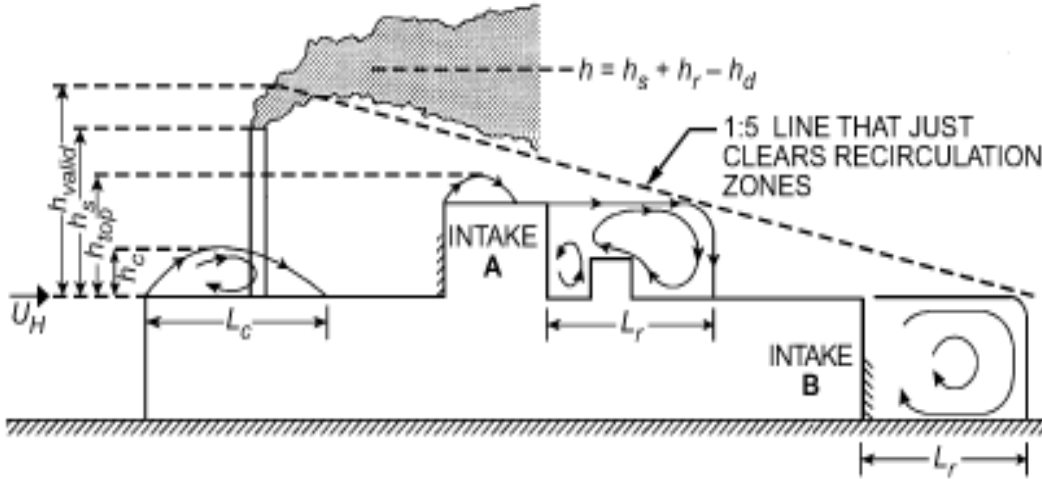

Figure 3.2 Flow recirculation regions and exhaust to intake stretched string distance (from ASHRAE Handbook (2003), Chap 44)

If the plume height does not reach h_{top} , then the following equation has to be used:

$$D_s = 4 \frac{U_H}{V_e} \left[0.071 \left(\frac{t_{\text{avg}}}{2.0} \right)^{0.2} \frac{S}{d_e} + \frac{\sigma_0}{d_e} \right] \left[0.071 \frac{S}{d_e} + \frac{\sigma_0}{d_e} \right] \quad (3.20)$$

where S is the stretched string distance, i.e. the shortest distance from exhaust to intake over obstacles and along building surface. All other terms in the formula have been defined previously and remain unchanged.

3.4 ASHRAE 2007 Model

The ASHRAE 2007 has recently been published and nearly resembles the 2003 version with a few changes that are mentioned below:

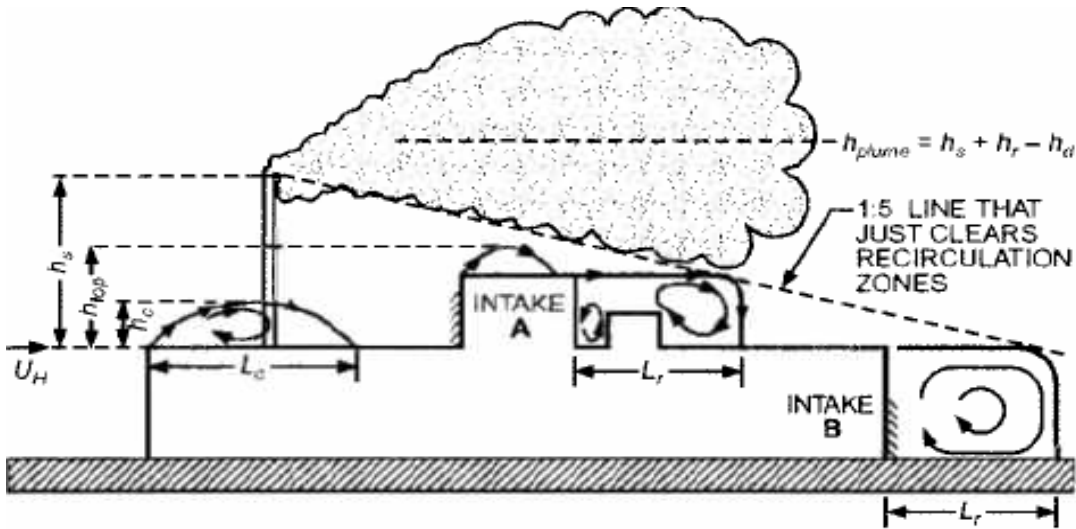

Figure 3.3 Flow recirculation regions and exhaust to intake stretched string distance (from ASHRAE Handbook (2007), Chap 44)

1) As compared to ASHRAE 2003, the term “ h_{small} ” is not used in the present version of ASHRAE which naturally simplifies the dilution calculations. This however leads to prediction of higher concentration of effluents at the receptor locations compared to ASHRAE 2003, as discussed in Chapter-5.

2) Equation 3.15 has been replaced by the following:

$$D_r = 4 \frac{V_e}{U_H} \times \frac{\sigma_y}{d_e} \times \frac{\sigma_z}{d_e} \exp\left(\frac{\zeta^2}{2\sigma_z^2}\right) \quad (3.21)$$

where $\zeta = h_{plume} - h_{top}$
 $= 0$ if $h_{plume} < h_{top}$

3) The term h_{valid} used in the 2003 version of ASHRAE, has been eliminated in the 2007 version for simplicity. This term essentially means the height of the stack which would completely overcome all the recirculation zones of the building (including all roof top obstacles).

3.5 U.S Environmental Protection Agency

Many of the dispersion models developed or accepted by the U.S Environmental Protection Agency (EPA) have been used in many countries besides USA. These models have been divided into several categories, which are briefly discussed in the following sub sections.

3.5.1 Preferred and Recommended Models

These models are used for assessment of far-field pollutant concentration; the most significant of them are:

- a) AERMOD - It is an atmospheric dispersion model which has been designed for estimating pollutant concentration from point, area or volume sources. It uses the Gaussian equations in stable atmospheric conditions and also takes into account the effect of building aerodynamics for evaluation of pollutant concentrations. This is a model in which Gaussian plume predictions have been corrected for building interference effects. The model has been extensively validated for near building transport by different wind tunnel laboratories including concentrations on the release building envelope.
- b) CALPUFF - It is a non-steady state dispersion model which simulates pollutant transport even in complex terrain. It consists of three units namely: CALMET, CALPUFF and CALPOST. The CALMET takes into account the meteorological inputs required for solving the problem. CALPUFF is the dispersion model for calculating pollutant concentration, while CALPOST is the post-processor which processes the data provided by CALMET and CALPUFF to display the effluent concentration as a contour plot. This software is also available freely on the EPA website.
- c) OCD - Offshore and Coastal Dispersion model is a Gaussian model used to determine effluent concentration in coastal areas. It incorporates the effect of the sea shore on pollutant transport for point, area or line sources.

Apart from those, there are a few others such as CALINE3, BLP, CTDMPPLUS etc, which have not been described in this section. A detailed discussion is available on the EPA website (<http://www.epa.gov>), but these models are not useful for this study because they are mostly suitable for far-field dispersion problems.

3.5.2 Alternative Models

These models are also used by various agencies for determination of pollutant concentration, a few of which are described briefly.

- a) ADAM - Air-force Dispersion Modelling System is a modified Gaussian model, which takes into account the aerosol chemistry, heat transfer and gas density for determining the effluent concentration.
- b) SLAB - This model is used for predicting the concentration of gases from evaporation of volatile spills which are denser than air. It uses the equations of momentum and the conservation of mass and energy.
- c) ISC3 - This is a Gaussian model which incorporates settling and deposition of particles downwash due to building and other obstacles and it operates for short-term and long-term releases. It can be used to simulate complex conditions such as the effect of buildings in the vicinity of the source of pollutants.

Apart from those, there are many other models such as DEGADIS, HGSYSTEM, HYROAD, ADMS, AFTOX etc, details of which can be found at the EPA website mentioned in section 3.5.1. Since ADMS and AFTOX have been used in this study, their description is included in section 3.6.

3.5.3 Screening Models

These models are normally used before using the preferred/alternative models. Some of them are:

- a) AERSCREEN - It is the screening version of AERMOD, described previously. It predicts much higher concentrations than the AERMOD model, since its method for estimating concentrations does not include meteorological data. The model is currently undergoing modifications before it could be available to people at large.
- b) TSCREEN - Toxic Screening model (TSCREEN) is a Gaussian model for screening toxic air pollutants. It is a combination of three models namely SCREEN3, PUFF and RVD (Relief Valve Discharge)

Another popular screening model is SCREEN 3, which has been used in this study and is discussed in detail in section 3.6. The other models described in this section have not been used because they do not simulate the existence of the building or roof top structure which affects pollutant transport for the cases considered in this study.

3.5.4 Photochemical Models

Photochemical models are used to evaluate pollutant concentrations by considering the physical and chemical processes of the atmosphere. Some of the popular models include CMAQ and REMSAD, details of which can be gathered from the EPA website. However, since these models do not simulate building aerodynamics which largely affect near-field pollutant concentration, no further discussion is made in this report.

3.5.5 Models Developed in other Countries

Many more models for assessing pollutant transport in near/far field dispersion problems have been developed in other countries. These models have not been accepted by EPA. Typical examples include:

GRAL (Austria), IFDM (Belgium), HAVAR (Czech Republic), AEROPOL (Estonia), MERCURE (France), DIPCOT (Greece), as well as AUSPUFF, LADM, TAPM, DISPMOD (all from Australia).

3.6 Models Used in the Study

The preceding section mentioned the various models that are widely in use in different parts of the world. Most of them are not available freely. A majority of software packages are only used for long range (several kilometres) dispersion modelling and hence cannot be used to solve dispersion problems for shorter distances, which merely constitute the building under consideration and its vicinity. Some other models like PRIME and AERMOD have not been used due to operational difficulties of the versions available in the EPA website during the execution of the present study.

In summary, of the various models discussed, the following have been used in this study:

- 1) ADMS 3.3
- 2) SCREEN 3
- 3) AFTOX
- 4) ALOHA

The results obtained from these models have been compared with ASHRAE and wind tunnel data which were available from previous studies. Each of these models is discussed in more detail in the following sub-sections.

3.6.1 ADMS 3.3

Atmospheric Dispersion Modelling System (ADMS) is an atmospheric dispersion model which was developed in the UK in collaboration by the Cambridge Environmental Research Consultants (CERC) with the University of Surrey and the UK Meteorological office. The model is capable of simulating dispersion of effluents from isolated stacks and from stacks placed on building roof. In this regard, the model takes into account the building downwash phenomena, effects of a complex terrain, coastal locations etc (ADMS User Guide, 2004). It can also model the effects of change in wind direction, which is not inherent in other models examined in this study. The US EPA has also considered it as one of the alternative models.

ADMS 3.3 has been used for modelling short-range dispersion problems. In this study a low-rise and a high-rise building have been considered with various stack heights and wind directions. The concentration of effluents has been estimated at various locations on the roof of the building, for known volumetric rates of gas release. A study involving the effects of roof top structure has also been done and these results have been compared to the ASHRAE and wind tunnel results obtained earlier. A detailed discussion of these cases along with graphical results is presented in Chapter-5 and Appendix A, of this report.

3.6.2 SCREEN 3

SCREEN 3 is a screening version of the ISC 3 model and is used to determine maximum ground level concentration of effluents for point, area or volume sources (SCREEN 3, User Guide, 1995). The minimum computational requirements constitute an IBM PC with 256K RAM, with or without a Math Coprocessor chip. It is an interactive and user friendly program; input data include the building and stack dimensions, effluent discharge characteristics and averaging time of release. The model can also simulate building downwash and complex terrain conditions. One of the greatest advantages of this model is that it is capable of estimating concentrations in less than 100 meters range, which makes it suitable for studying the cases dealt with in this report. Additional information on SCREEN 3 model can be obtained from the SCREEN 3 User Guide, 1995.

Several cases involving a low-rise and a high-rise building with and without a roof structure have been examined in this study. These cases have been discussed in detail in Chapter-5. Appendix B gives a sample input-output for a low-rise building with a stack of

one metre. As can be seen from the input file, SCREEN considers a default value of wind speed equal to 10 m/s at 10 m anemometer height. It is also worth mentioning that the plume height is lower than the building height itself, which explains that there is stack tip downwash due to the low stack height and exhaust momentum. SCREEN does not consider the building dimensions while calculating concentrations and hence takes the stack height from the ground level.

3.6.3 AFTOX

Air Force Toxic Chemical Dispersion model (AFTOX) is a Gaussian dispersion model capable of simulating the release of gases from point or area sources. It contains 130 chemicals in its system and can accept additional chemicals (AFTOX User Guide, 1993). It is available freely on the EPA website, and it comes as an executable file. Unlike most other models, this model can simulate all atmospheric stability conditions. Additional details can be obtained from the EPA website.

AFTOX has been used to simulate the cases involving exhaust from high-rise buildings, as well as low-rise buildings with roof top structures. Details are provided in Chapter-5. Appendix C also provides some additional results.

3.6.4 ALOHA

The term ALOHA stands for Aerial Locations of Hazardous Atmospheres. As the term suggests, this model is used for determining pollutant concentrations due to the release of hazardous chemicals. It can also model the effects of explosions and fires. This model has been developed by the EPA's Chemical Emergency Preparedness Office (CEPPO).

There are two distinct ways that ALOHA can model a gas namely by using the popular Gaussian equations or by considering the gas as a "heavy gas" (ALOHA User manual, 2006). However since SF₆, which is a reasonably light gas, was used in the experimentation for the cases considered in this study, the Gaussian equations were in the model for all cases. Additional information pertaining to the model can be obtained from the ALOHA User manual, which is available freely on the internet.

ALOHA is also capable of estimating the amount of toxicity involved during emissions. It provides output in the form of contour plots (Appendix D) for easy understanding.

Chapter-4

Wind Tunnel Experimentation

4.1 General

Since a majority of the results have been based on the experiments performed in the wind tunnel, therefore it is deemed to be necessary to provide some details about the Boundary Layer Wind tunnel at Concordia University and its accompanying instrumentation used in dispersion experiments.

4.2 Boundary Layer Wind Tunnel and Instrumentation

Wind tunnel experimentation was carried out at the Boundary Layer Wind Tunnel Laboratory at Concordia University, Montreal, Canada. It is an open circuit boundary layer wind tunnel of 1.8m by 1.8m in section and 12.2 m in length. Two models representing 15 m and 60 m high buildings in full-scale, were tested on a scale of 1:200, in the wind tunnel. Figures 4.1 and 4.2 show the front view and sections of the wind tunnel set up giving the necessary geometrical details.

According to Snyder (1981) the following criteria should be satisfied, for modelling non-buoyant plume exhaust:

- Geometric similarity
- Building Reynolds Number > 11000
- Stack Reynolds Number > 2000
- Similarity of wind tunnel flow with wind flow in the atmospheric surface layer
- Equivalent stack momentum ratio.

These criteria have been taken care of, while performing the experiments.

The roof height is sufficient for development of the plume rise which did not, have any effect on the vertical and horizontal spread of the plume in the wind tunnel since the highest stack height used in the study was 3.5 cm (representing a 7 m tall stack in full-scale). The roof of the tunnel was adjusted to ensure that the longitudinal static pressure gradient was negligible.



Figure 4.1 Front view section of the Boundary Layer Wind tunnel at Concordia University.

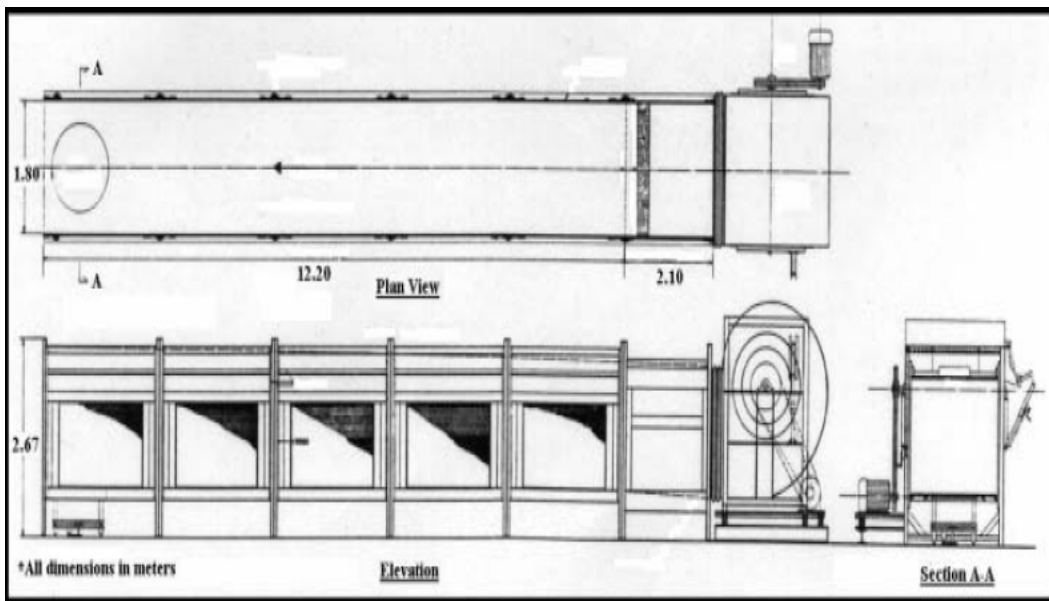

Figure 4.2 Plan and elevation of the Boundary Layer Wind Tunnel at Concordia University

Figure 4.3 shows the building model with stack, which was used for the study. The model was built of timber on a scale of 1:200. The tiny holes near the stack represent receptors, connected to suitable tubing underneath the tunnel. The wind flow in the wind tunnel was turbulent and stable throughout the tests. The tests were conducted for two wind directions namely: wind direction normal to the roof and at 45 degrees to the roof. During the tests the wind speed and direction were constant with time and there were no timely variations. All the cases examined have been described in detail in Chapter-5. A neutral stability class was assumed during the experiments since this represents most critical cases. In the past, several field experiments were conducted and simulated in the wind tunnel (Stathopoulos et al, 1999) using neutral stability to yield matching results. A nearly urban terrain was chosen ($\alpha = 0.3$) for which several roughness generating elements were placed in the wind tunnel (Figure 4.1).

When full-scale averaging time increases, mean concentration decreases due to plume meander caused by turbulence and fluctuation in wind direction. Wind tunnels can only model plume meander due to small-scale turbulence since the walls restrict the flow in the lateral direction (Stathopoulos et al, 1999). When the source and receptor locations lie in the same recirculation zone, as in the present study, the effects of averaging time are expected to diminish. In such cases, ASHRAE (1993, 1997) suggests that dilution values obtained up to an averaging time of 3 minutes in the wind tunnel correspond to full-scale averaging time up to one hour. The averaging time for collection of the samples in the experiments carried out in the wind tunnel was only one minute, although ASHRAE 2003 suggests an averaging time of two minutes. For all models (ALOHA, ADMS, SCREEN AND AFTOX) examined, the averaging time was set to one minute, to make them comparable to ASHRAE and wind tunnel results. The samples were collected once the emission of the gas in the wind tunnel was stable after about 4 minutes and then the samples were collected in syringes using a syringe sampler. The duration of the emission does not have an effect on the wind tunnel results since this is not a far-field dispersion problem where hourly emissions ranging several kilometres are a common feature. However, the possibility of any background concentration affecting the results is reduced since the samples were collected by syringes connected via tubing's to the receptors. The syringes were organised in a syringe sampler having a mechanism by which the syringes can be fixed to the instrument so that they could suck the air samples within one minute, once the wind tunnel and release of gas are stabilized. Any background concentration of SF₆ in the wind tunnel was removed quickly by the ventilation system of the laboratory.



Figure 4.3 Building model representing a 15 m tall building, used for the study

A mixture of Sulphur hexafluoride (SF_6) and nitrogen, released from stacks of different heights and varying exhaust momentum (M), was used during the tracer gas experiment. The SF_6 gas was released from a tube connecting the mass flow controller and mass flow-transducer regulating its flow from the stack. More details about the measurement system can be found in the equipment brochure titled “Flow Components and Controls”, Matheson Tri-Gas, USA, 2007.

The wind velocity and turbulence intensity profiles are shown in Figure 4.4. The gradient height measured was 170 m in full-scale, which corresponds to 0.85 m in the wind tunnel.

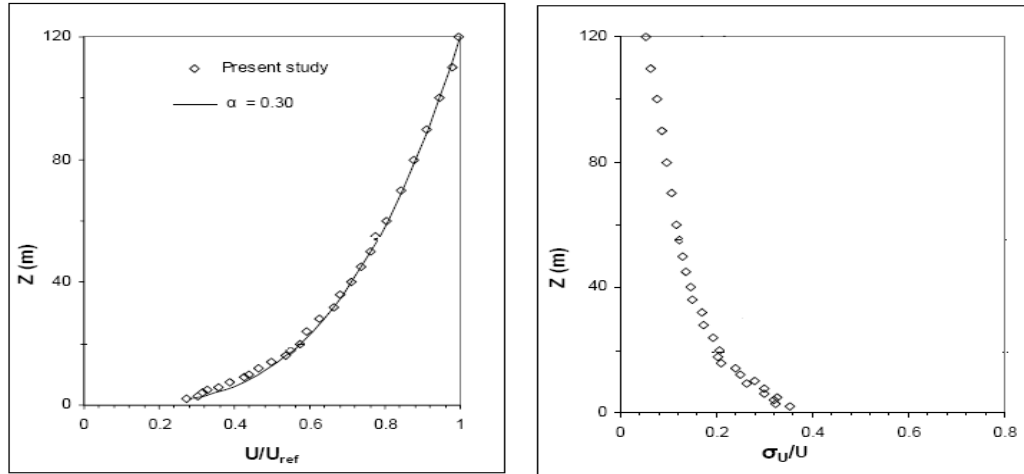

a) Mean Velocity Profile

b) Turbulence Intensity

Figure 4.4 Mean velocity and turbulence intensity profiles measured at the Boundary Layer Wind tunnel of Concordia University (Stathopoulos et al, 1999)

In this connection, the average velocity at the building height in the wind tunnel was 5.4 m/s. The measurements were generally repeatable to within $\pm 20\%$ (Stathopoulos et al, 1999). The concentration of the tracer gas was measured at the roof top of the building model. Dilutions were calculated from equations 3.15 and 3.21, which correspond to ASHRAE 2003 and 2007 respectively. These were then compared to the results obtained from the other analytical models, used in this study. Since it was assumed that the buildings considered in all cases were in an urban terrain, which corresponds to terrain category 2 (ASHRAE 2005 chapter 16, pp-16.3, table 1), a power law exponent of 0.3 was used to determine U_H . The model value of the longitudinal integral scale was 0.4 m, which corresponds to a full-scale value of 80 m. The model roughness length of the upstream exposure was 3.3 mm, which corresponds to a full-scale roughness length of 0.66 m. The Reynolds number for the building model was found to be approximately 20,000, which is larger than 11,000, while the stack Reynolds number was nearly 1800.

A Gas Chromatograph (GC) was used to assess the gas concentrations that were collected using the syringe samplers. Deviations in concentration measurements were usually within $\pm 10\%$ (Stathopoulos et al, 1999). Figure 4.5 shows a schematic diagram of the tracer gas experimental system in the Boundary Layer Wind Tunnel lab of Concordia University.

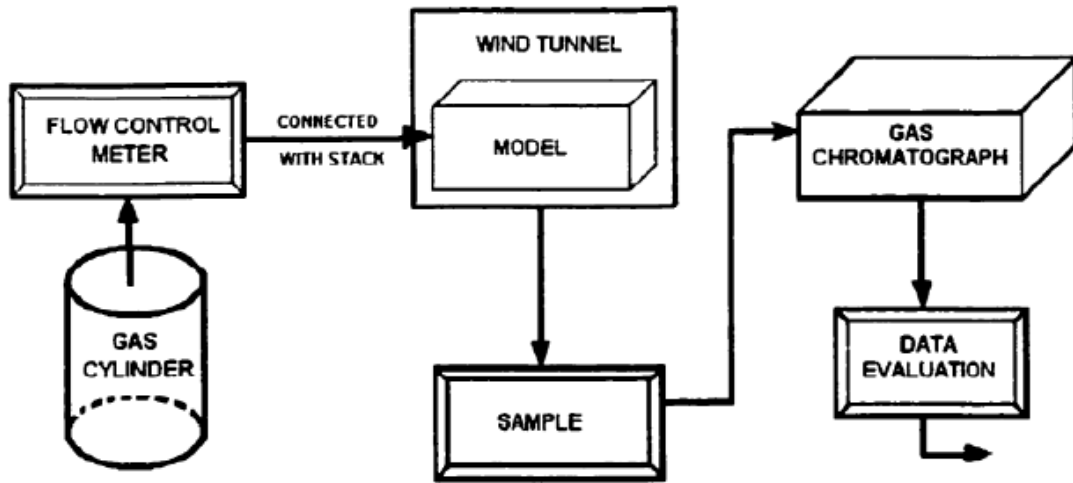

Figure 4.5 Tracer Gas Experiment System (from Gupta, 2008)

Chapter-5

Results and Discussion

5.1 General

During the course of this project, various cases were studied, as elaborated in the following sections. ASHRAE has given formulations for determining the normalised dilution from the concentrations (details have been discussed in Chapter-3). Since the software used for comparison give results in terms of concentrations, the following formulation, suggested by Wilson et al, 1979 has been used for evaluating the normalised dilution:

$$D_{\text{normalised}} = D_r Q / (U_H H^2) \quad (5.1)$$

where

D_r is the dilution

Q is the flow rate

U_H is the wind speed at height 'H'

H is the height of the building under consideration

The Briggs plume rise equation (equation 3.7, Chapter-3) was used to determine the stack height. As mentioned earlier in Chapter-4, neutral stability was considered while performing the experiments in the wind tunnel. However, past studies have shown that this is effective in simulating actual (field) conditions (Stathopoulos et al, 2004).

5.2 Case 1: Low-rise Building

A square plan view (50 x 50 m) low-rise building of 15 metres height was considered for the study of dispersion of effluents. To get a clear idea of the building, stack and receptor location, a pictorial representation has been shown in Figure 5.1. The study essentially involves a comparison of the various EPA models such as ALOHA (Areal Locations of Hazardous Atmospheres), SCREEN 3, AFTOX (Air Force Toxic Model) and ADMS 3.3 with the ASHRAE (2003 and 2007) and wind tunnel data. The gas used for the wind tunnel experimentation was SF_6 . The building is assumed to be located in an urban terrain.

The height of stack has been varied from 1 to 7 metres for increasing values of exhaust momentum (M).

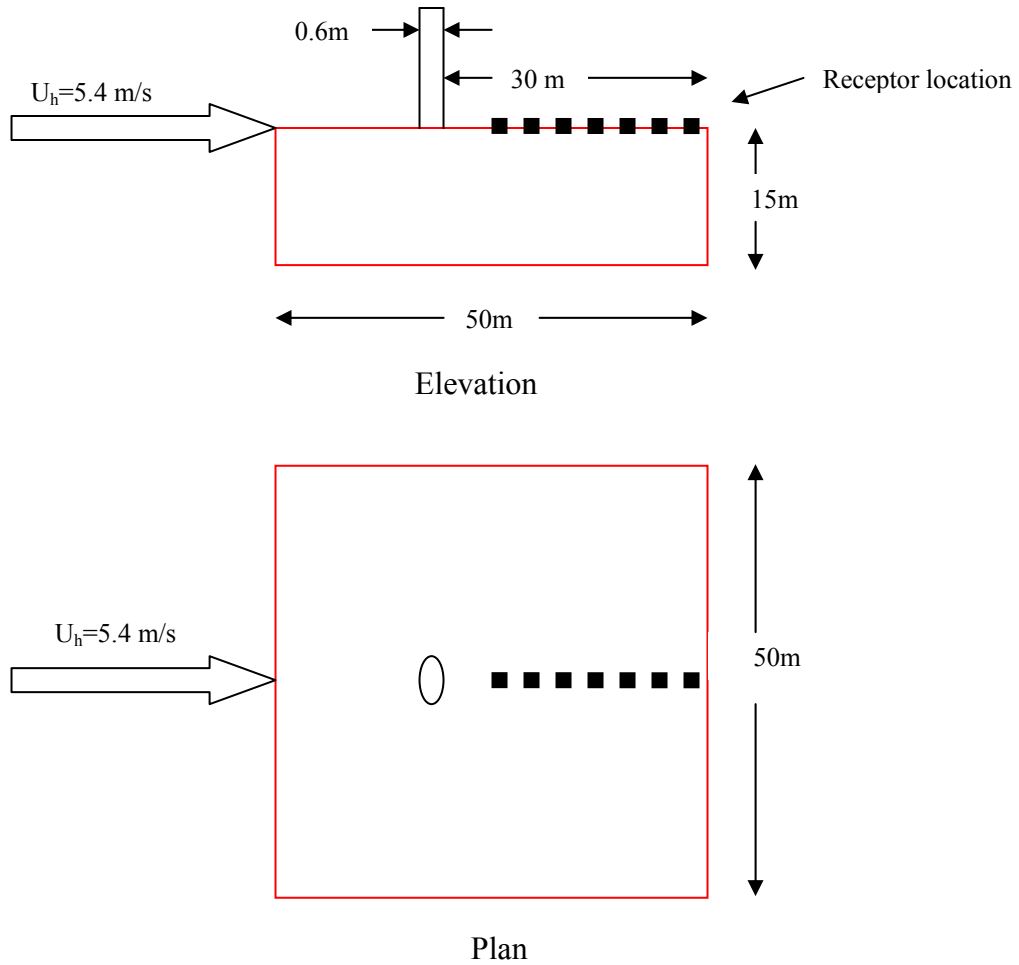
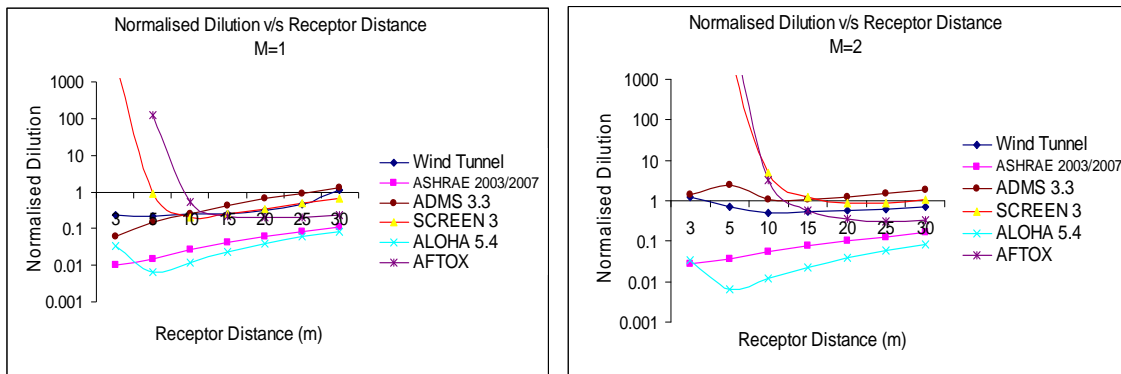

Figure 5.1 Low-rise building with stack and receptor location



(a)

(b)

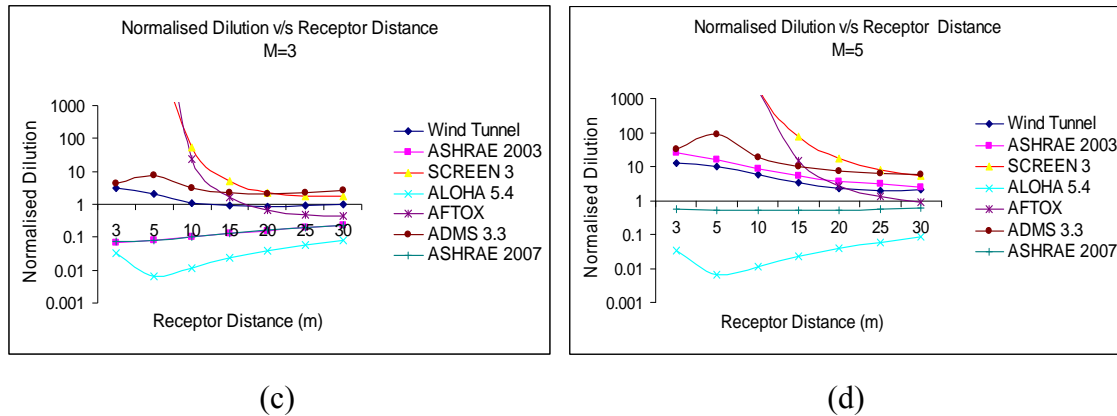

Figure 5.2 Normalised dilution versus receptor distance for a one-metre high stack

Discussion: A 15-metre high low-rise building was tested in the wind tunnel for increasing values of exhaust momentum and varying stack height. The receptors were located downwind of the stack at the roof top. Results were compared to those derived by using the ASHRAE models and with some of the popular EPA models.

Figure 5.2 shows that for cases of low exhaust momentum ($M=1$ and $M=2$), comparable dilutions are obtained for the wind tunnel data and those obtained by SCREEN 3, AFTOX and ADMS 3.3 beyond ten metres receptor distance. It may also be noted that the initial values obtained by SCREEN 3 and AFTOX are on the higher side within the first ten metres from the stack location, while results obtained from ALOHA 5.4 and ASHRAE are comparable and found to be ten times lesser than the other models. For higher values of M (Figures 5.2(c) and 5.2(d)), SCREEN 3 produces the highest and ALOHA 5.4 the lowest values of normalised dilution, respectively, while the other models show intermediate values. The maximum deviation that SCREEN 3 produces with respect to the wind tunnel data is about 100 times more, while dilutions obtained by ALOHA 5.4 are about 100 times less than the wind tunnel results. In general, there is significant discrepancy within the first ten metres from the stack and thereafter the curves tend to get closer. This discrepancy is attributed to the fact that a large majority of the EPA models are based on the Gaussian equations, which are more applicable for larger receptor distances as quoted by several experts earlier (see section 3.6). It is also worth noting that ASHRAE 2003 compares well with the present version of ASHRAE 2007 for low exhaust momentum ($M=1,2,3$) but for $M=5$ (Figure 5.2 (d)) ASHRAE 2007 predicts very low dilutions (less than ten times) compared to ASHRAE 2003 and wind tunnel data. The calculations in the ASHRAE 2007 have become simpler compared to ASHRAE 2003 by avoiding certain ambiguous terms such as h_{small} in calculating the dilutions. However the receptor concentrations evaluated by ASHRAE 2007 are much higher compared to those from ASHRAE 2003 which makes it necessary for the designer to take additional care while building a stack and intake structure. This also gives rise to the inconsistency of ASHRAE 2007 values with other models for higher exhaust momentum. A similar trend is observed with higher stack height as discussed in subsequent sections of this Chapter.

Figure 5.3 shows normalised dilutions for the same roof level receptors for the low-rise building for a stack of height equal to two metres.

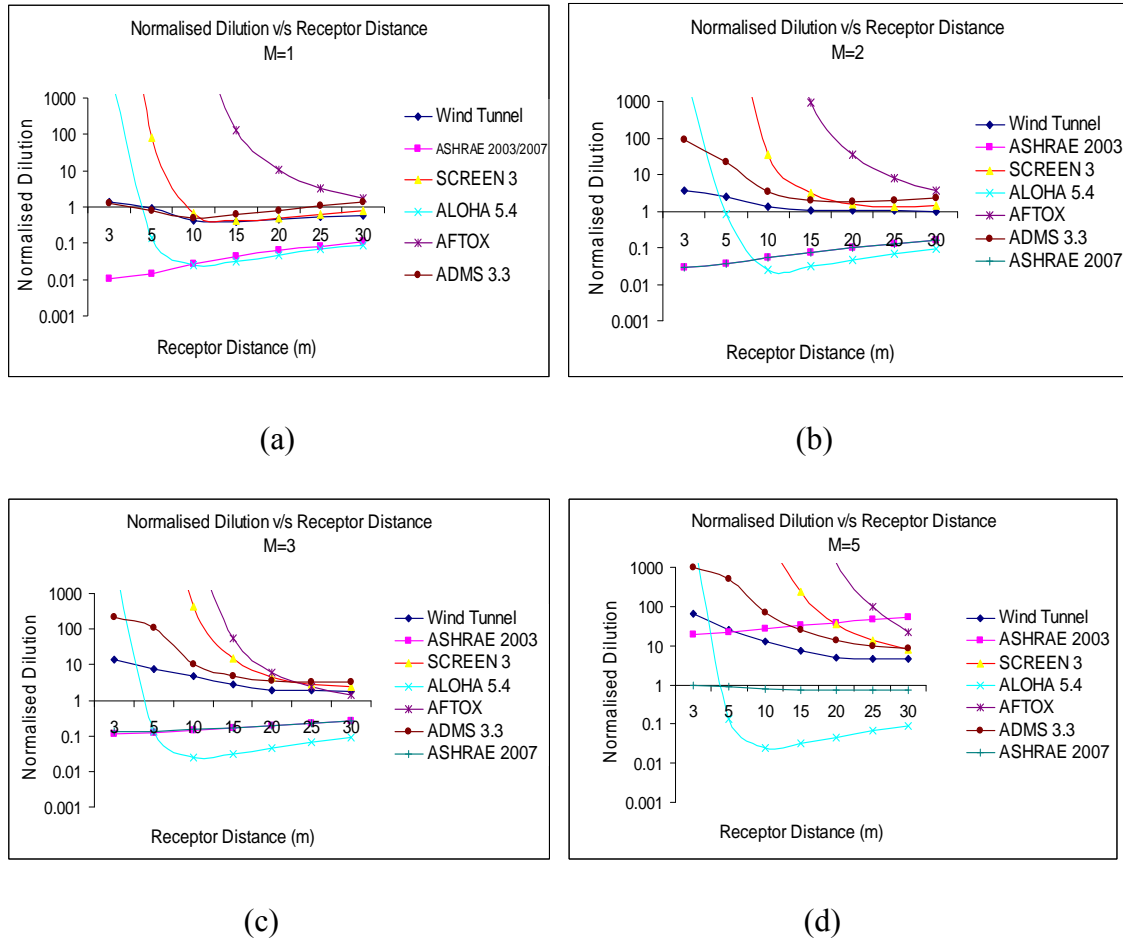

Figure 5.3 Normalised dilution versus receptor distance for a two-metre high stack

Discussion: Figure 5.3 shows that at low exhaust momentum ($M=1$ and $M=2$), the values obtained from SCREEN 3 and ADMS 3.3 compare well with the wind tunnel data after a distance of about 10 metres from the stack. Nearly comparable values are also obtained from ALOHA and ASHRAE 2003, but these are almost 100 times lower than the respective wind tunnel results. It is also interesting to note that the normalised dilutions obtained from ALOHA do not change significantly with increasing values of exhaust momentum (M). However, AFTOX gives much higher dilution values with increasing values of M . At higher values of exhaust momentum the discrepancy between SCREEN 3, ADMS 3.3 and wind tunnel data increases greatly, while ASHRAE gives much lower values. As already discussed, ASHRAE 2007 predicts lower dilutions for $M=5$ compared to 2003 version. It is interesting to note that the graphs of ASHRAE 2007 and wind tunnel follow in general a parallel path in contrast to ASHRAE 2003, which intersects the graph plotted from wind tunnel data at 5 m from the stack for $M=5$.

Figure 5.4 shows the case of a low-rise building with a stack height of three metres

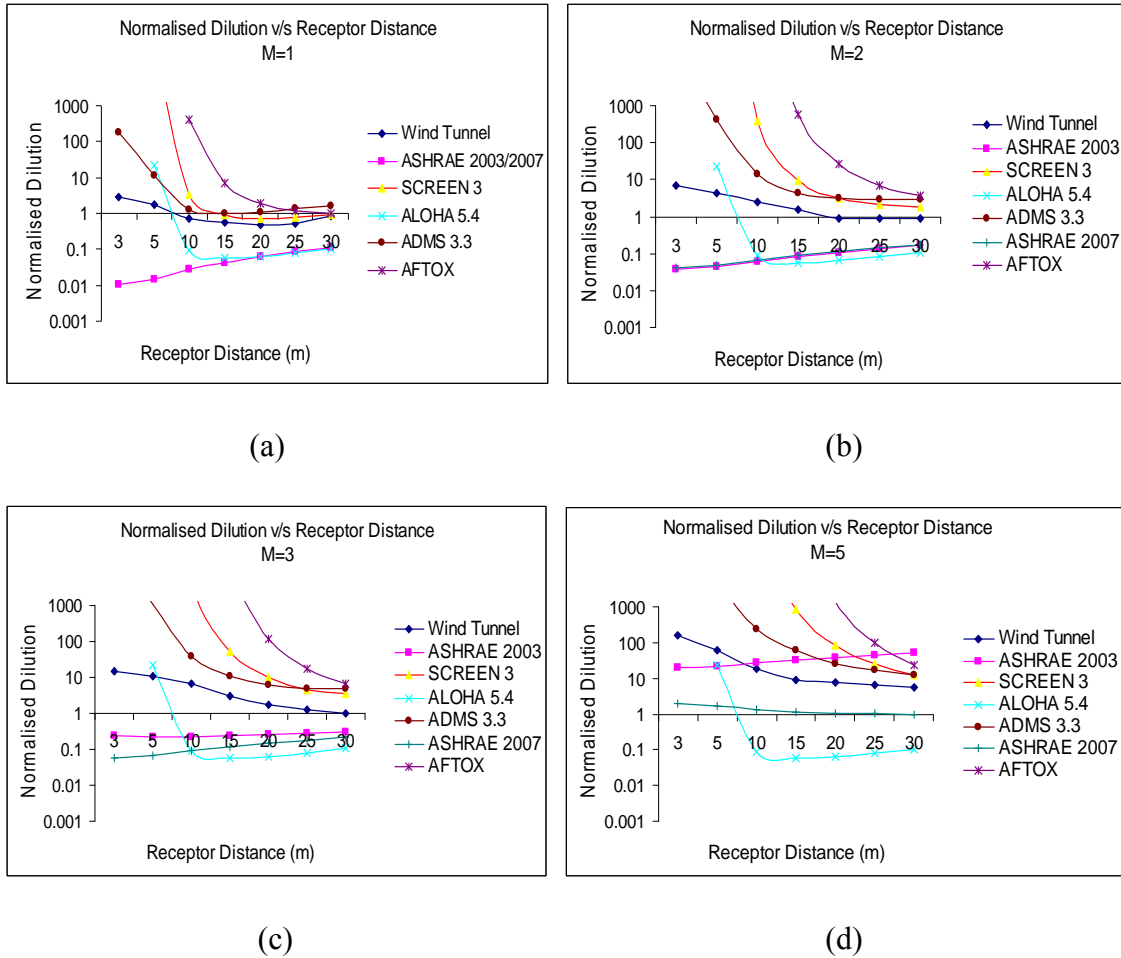

Figure 5.4 Low-rise building with a three-metre high stack

Discussion: Figure 5.4 shows that at low exhaust momentum ($M=1$ and $M=2$), the values obtained from wind tunnel and ASHRAE 2003 and 2007 produce larger deviations (of about 100 times), which cease to exist at higher values of M (Figure 5.4 (c) and (d)) where they compare well. It is also worth noting that AFTOX does not produce any values of dilution for higher stack height. Models such as SCREEN, ADMS and ALOHA give much higher dilution values at shorter distances from the stack indicating their unsuitability for the given problem. It is also observed that ASHRAE 2007 gives lower dilutions compared to the 2003 version thereby predicting higher receptor concentration of effluents.

Another case involving a stack height of 5 metres is also discussed in Figure 5.5.

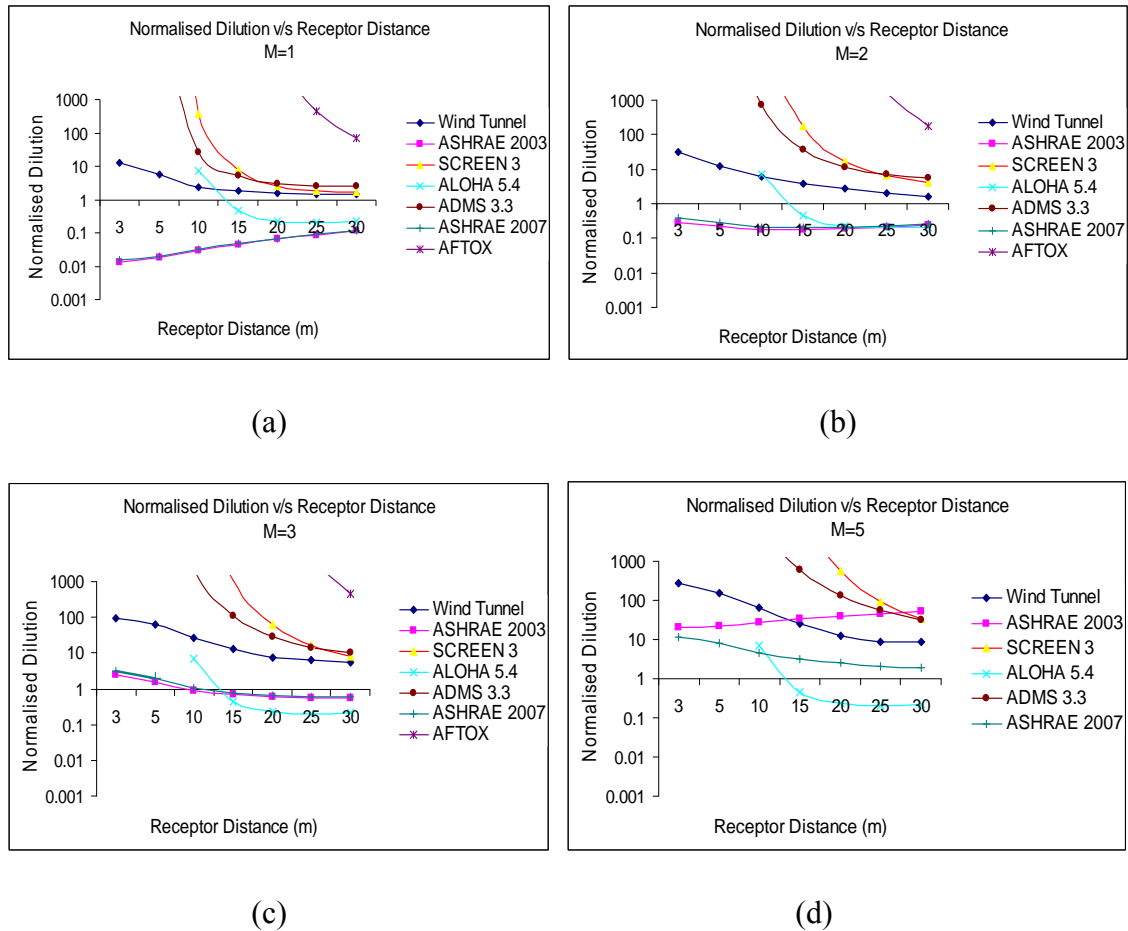

Figure 5.5 Normalised dilution versus receptor distance for a five-metre high stack.

Discussion: Figure 5.5 shows that at low exhaust momentum ($M=1$ and $M=2$), dilutions obtained from wind tunnel and ASHRAE produce larger deviations (of about 100 times), which cease to exist at higher values of M (Figure 5.4 (c) and (d)). It is significant that ASHRAE 2003 predicts rising dilutions when the wind tunnel and other models show clearly decreasing values. This is more likely to occur for taller stacks considering the plume configuration spreading with the maximum dilution at roof levels. It is also worth noting that AFTOX does not produce any values of concentration/dilution for higher stack height. A similar feature is also observed for the high-rise building, as will be discussed later. The models such as SCREEN, ADMS and ALOHA give much higher dilution values at shorter distances from the stack indicating their unsuitability for the given problem. ASHRAE 2007 produces lower dilutions at $M=5$ compared to ASHRAE 2003, which is similar to that observed in previous cases.

Finally a case involving a stack height of seven metres is shown in Figure 5.6.

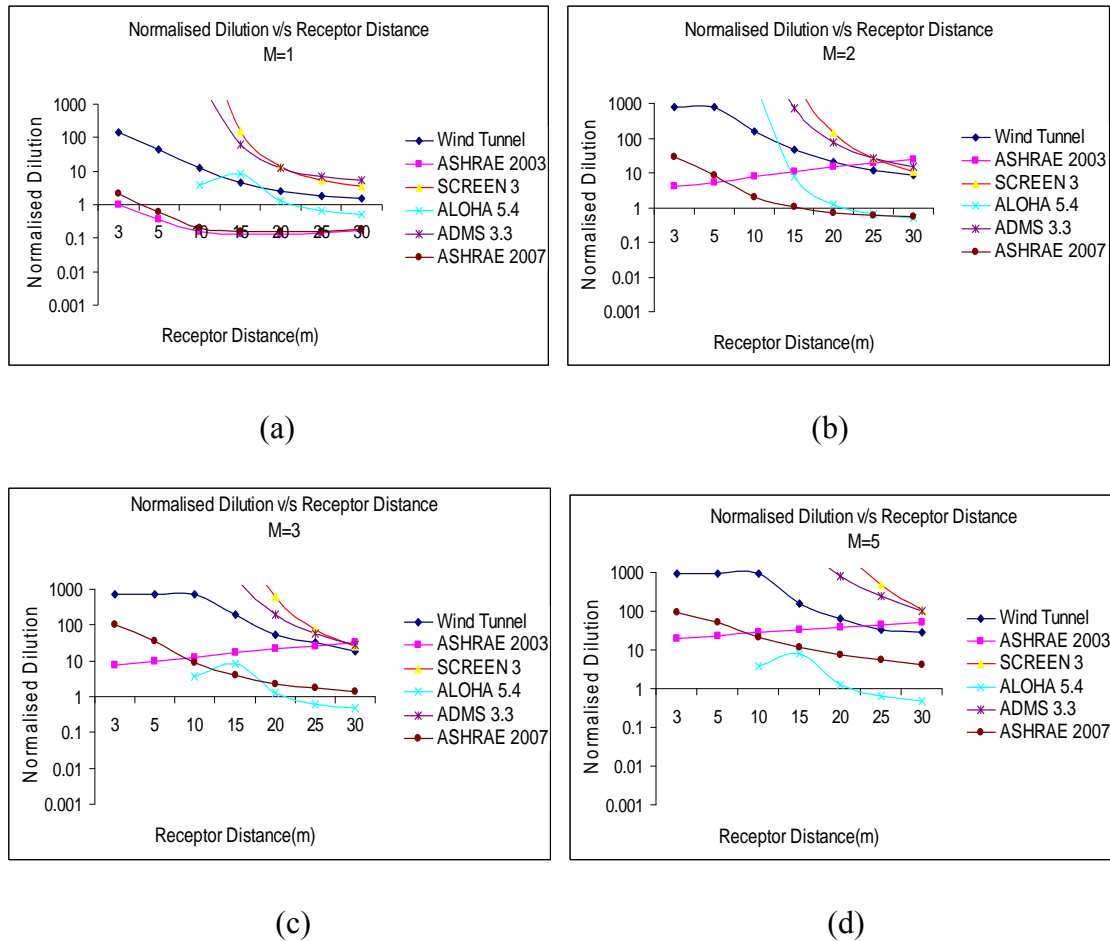

Figure 5.6 Normalised dilution versus receptor distance for a seven-metre high stack.

Discussion: Figure 5.6 shows nearly similar behaviour for a low-rise building with stack height of seven metres. Low exhaust momentum ($M=1$ and $M=2$), produce larger deviations (of about 100 times), between ASHRAE 2003 and wind tunnel results. SCREEN, ADMS and ALOHA give much higher dilution values at shorter distances from the stack indicating their unsuitability for the given problem. Interestingly the graphical plots of ASHRAE 2007 and wind tunnel results follow a parallel path unlike ASHRAE 2003 which intersects the graph based on wind tunnel data at 20 m away from stack at higher exhaust momentum. It should be noted here that although the fact that wind tunnel dilutions are reported as constant at 10 m from the stack, this may be attributed to experimental errors (e.g. background level of concentration in the facility or instrumentation sensitivity), corresponding field data have shown a similar behaviour (Stathopoulos et al, 1999).

5.3 Case 2: High-rise Building

A high-rise building of 60 metres height with the same horizontal dimensions as the previous building was considered for the study of dispersion of effluents. Details of the building are provided in Figure 5.7. Various EPA models such as ALOHA (Areal Locations of Hazardous Atmospheres), SCREEN 3 and ADMS 3.3 have been compared to the ASHRAE and wind tunnel data. However, AFTOX does not produce any concentration values for the given building because of its height limitations.

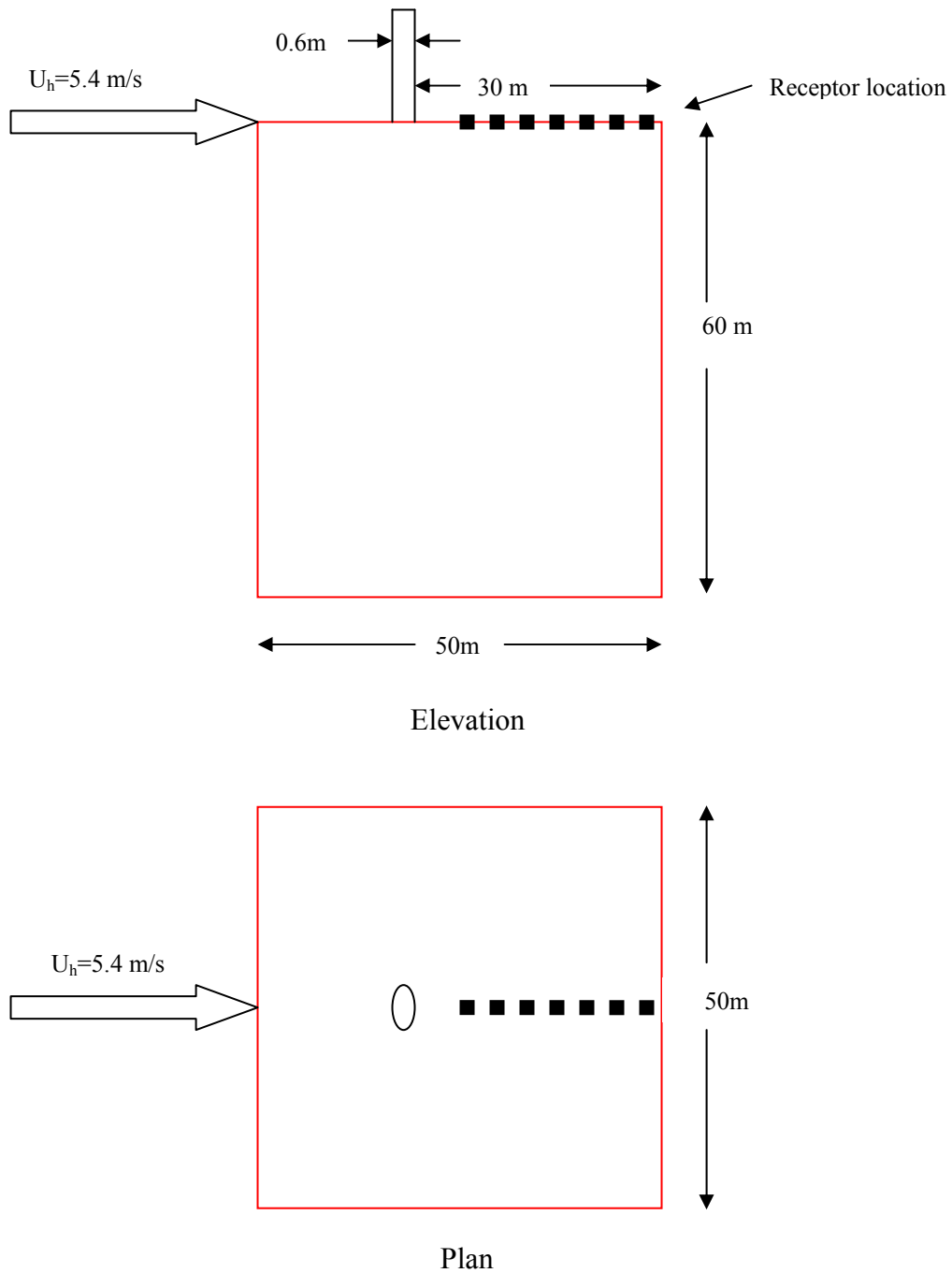

Figure 5.7 High-rise building with stack and receptor location

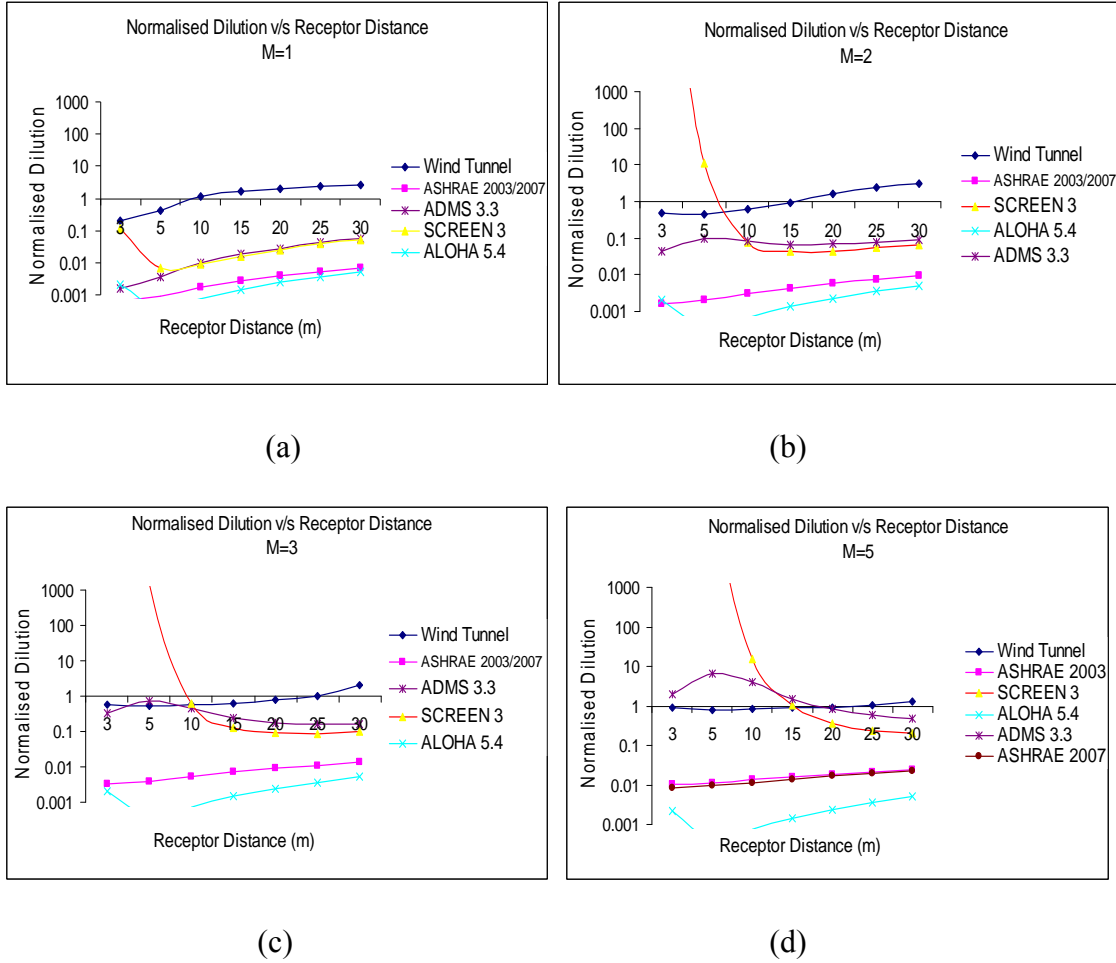

Figure 5.8 Normalised dilution versus receptor distance for a one-metre high stack; high-rise building

Discussion: Figure 5.8 shows that the normalised dilution values obtained from wind tunnel are on the higher side compared to the other models. It is of interest that ADMS 3.3 and SCREEN 3 models are comparable after a receptor distance of about ten metres, which is not the case with higher exhaust momentum. ALOHA 5.4 and ASHRAE produce much lower values of dilutions (of about 100 times less), compared to the wind tunnel data. In this case ASHRAE 2003 and 2007 versions compare well for low and high exhaust momentum, although significantly lower than the wind tunnel results.

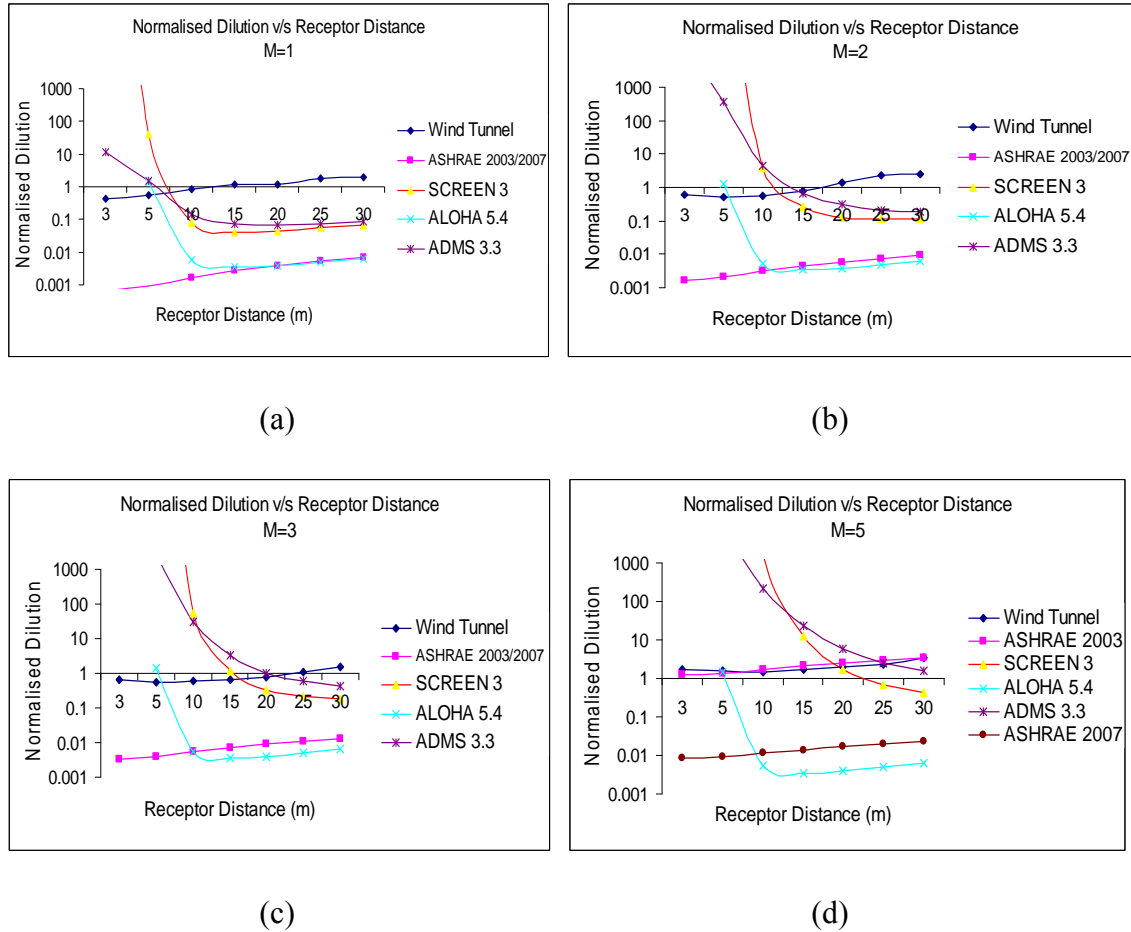

Figure 5.9 Normalised dilution versus receptor distance for a three-metre high stack; high-rise building

Discussion: Figure 5.9 show that the normalised dilution values obtained from wind tunnel are on the higher side especially after the first fifteen metres from the stack, but they gradually converge with the other models with increased exhaust momentum. It is also worth noting that ALOHA and ASHRAE compare well at lower values of “M” but this scenario changes drastically for higher values of “M” where the deviation is considerably large (almost 100 times). Initially ALOHA and ASHRAE produce lower values of dilution (about 100 times less) than the wind tunnel for lower M; however for higher values of M, ASHRAE compares well with the wind tunnel. The most common problem with most of the EPA models (SCREEN 3, ADMS 3.3 and ALOHA 5.4) is that they produce higher dilution values for the first fifteen metres and tend to converge with the other models thereafter. Initially there is sufficient discrepancy between ASHRAE 2003 and wind tunnel (M=1, 2, 3) but at M=5 this ceases to exist. However, ASHRAE 2007, which initially compared well with 2003 produces about ten times smaller dilutions compared to the previous version of ASHRAE.

Figure 5.10 shows the normalised dilution for the high-rise building with a stack height of five metres.

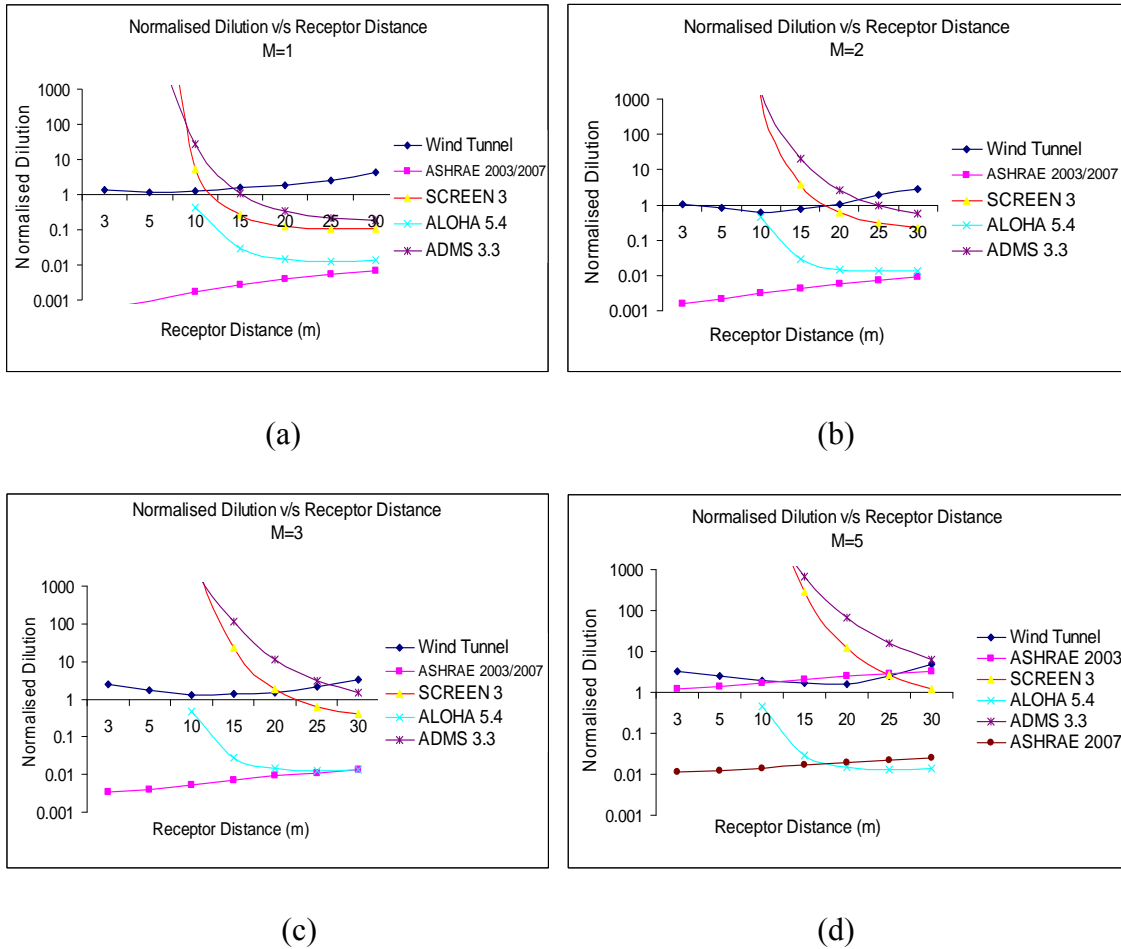

Figure 5.10 High-rise building with a stack height of five metres

Discussion: Figure 5.10 shows that the normalised dilution values obtained from wind tunnel are on the higher side compared to the other models after a receptor distance of ten metres for lower values of M. Interestingly the ASHRAE 2003 and wind tunnel results are comparable at M=5, while at lower values of M the deviation is almost a hundred times. SCREEN 3 and ADMS 3.3 produce the highest values of dilution within the first 10 metres receptor distance which is impractical. It is also worth noting that ASHRAE 2007 produces very low dilution values at M=5 which makes it necessary for existing designers to change their design criteria on stack construction.

Figure 5.11 shows the normalised dilution for the high-rise building with a stack height of seven metres.

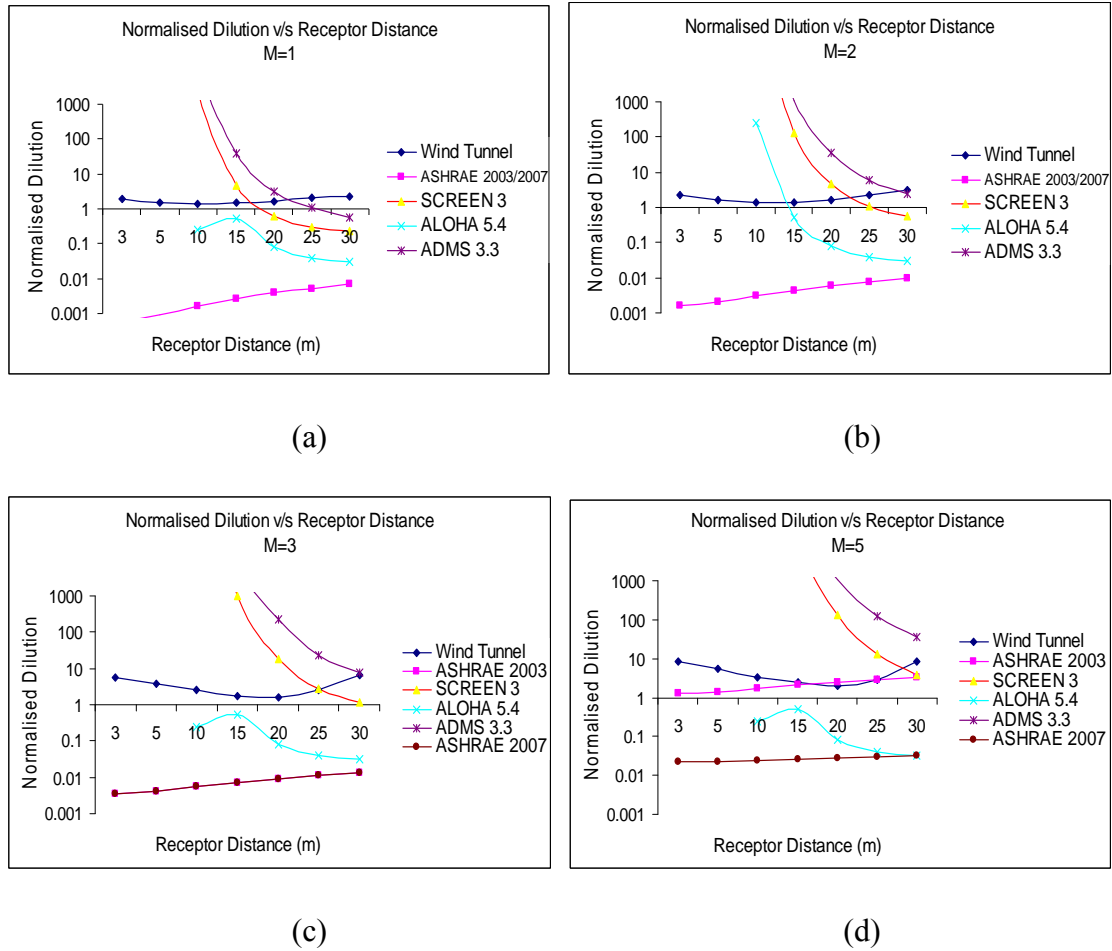

Figure 5.11 High-Rise building with a stack height of seven metres

Discussion: Figure 5.11 shows the normalised dilution for the high-rise building with a stack height of seven metres. It is observed that for higher values of stack height for the given high-rise building the normalised dilution values keep increasing with receptor distance but after a certain distance, reach a relatively constant value. It may also be noted that ASHRAE 2003 and 2007 versions compare well at lower values of M but deviate by more than 10 times for M=5. The present version of ASHRAE over predicts receptor concentrations compared to ASHRAE 2003 and wind tunnel results and is not consistent with other EPA models.

5.4 Case 3: Low-rise Building with Roof Top Structure

A low-rise building of 15 metres height was considered for the study of dispersion of effluents. Details of the building and roof top structure are mentioned below in Tables 5.1 and 5.2 respectively. A pictorial representation is also presented in Figure 5.12. Various

EPA models such as ALOHA (Areal Locations of Hazardous Atmospheres), SCREEN 3, AFTOX and ADMS 3.3 have been compared to the ASHRAE and wind tunnel data. The building is assumed to be located in an urban region and has receptor locations downwind of the stack. The roof top structure is assumed to be located upwind of the stack. According to Stathopoulos et al (2004) "*roof top obstacles can significantly alter dispersion from exhaust stacks immediately downwind of the obstacles and of similar height to the obstacles*". Four cases involving stack height of 1, 3, 5 and 7 metres were examined.

Table 5.1-Building details

| |
|-----------------|
| Height = 15 m |
| Width = 50 m |
| Breadth = 50 m |
| $d_e = 0.6$ m |
| $U_h = 5.4$ m/s |

Table 5.2-Roof top structure details

| |
|---------------|
| Height = 4 m |
| Width = 30 m |
| Breadth = 8 m |

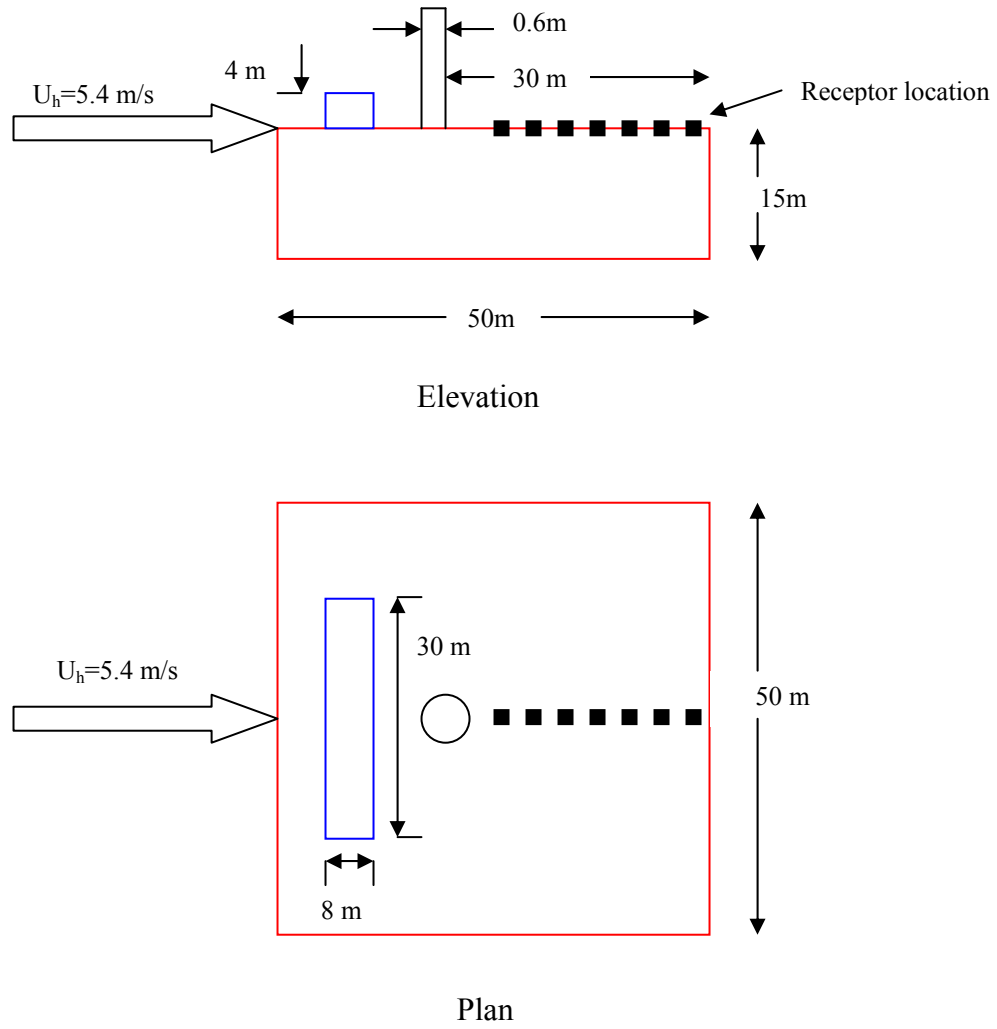

Figure 5.12 Low-rise building with roof top structure

Figure 5.13 shows the normalised dilution for the low-rise building with roof top structure, with a stack height of one metre.

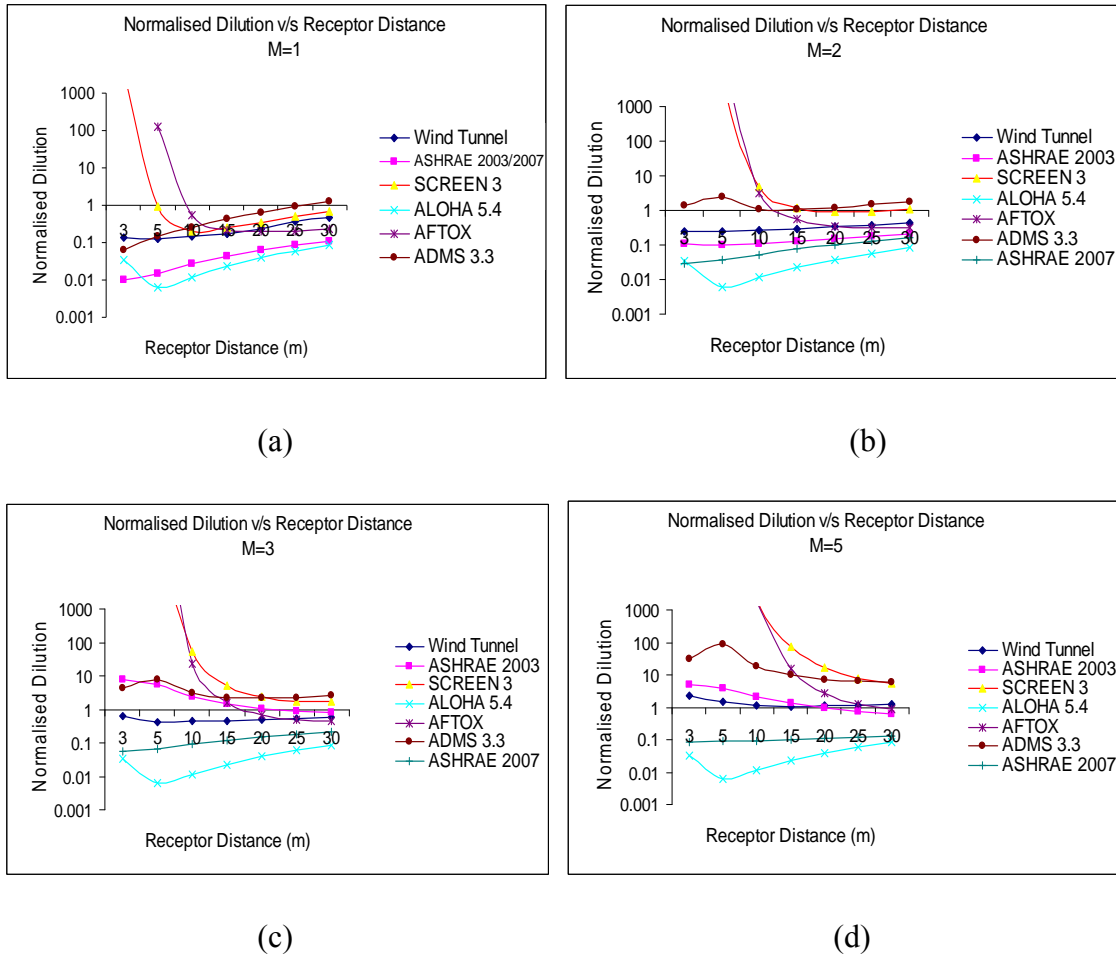

Figure 5.13 Normalised dilution versus receptor distance for a stack height of one metre; low-rise building with roof top structure

Discussion: It may be observed from Figure 5.13 that at low exhaust momentum the curves tend to converge after 10 metres from stack, but ADMS gives the highest and ALOHA 5.4 the lowest values of dilution. As the exhaust momentum increases SCREEN 3 produces the highest values of dilution while ALOHA the least, while all other models give intermediate results. The other interesting aspect that can be noted is that the wind tunnel and ASHRAE 2003 results coincide as exhaust momentum increases. However the ASHRAE 2007 predicts almost ten times higher receptor concentrations compared to the 2003 version for higher exhaust momentum (M=2, 3, 5). For M=1 both versions of ASHRAE compare well. It is worth noting that in previous cases involving no roof top structure ASHRAE 2003 and 2007 compared well for lower exhaust momentum and stack height, but the discrepancy increased with increasing the height of stack and the value of M. However, the roof top structure increases the dilution values with an increase in exhaust momentum; this increase is more pronounced for all other EPA models

considered including ASHRAE 2003, except the present version of ASHRAE and ALOHA 5.4 which produce dilution values far below the other models.

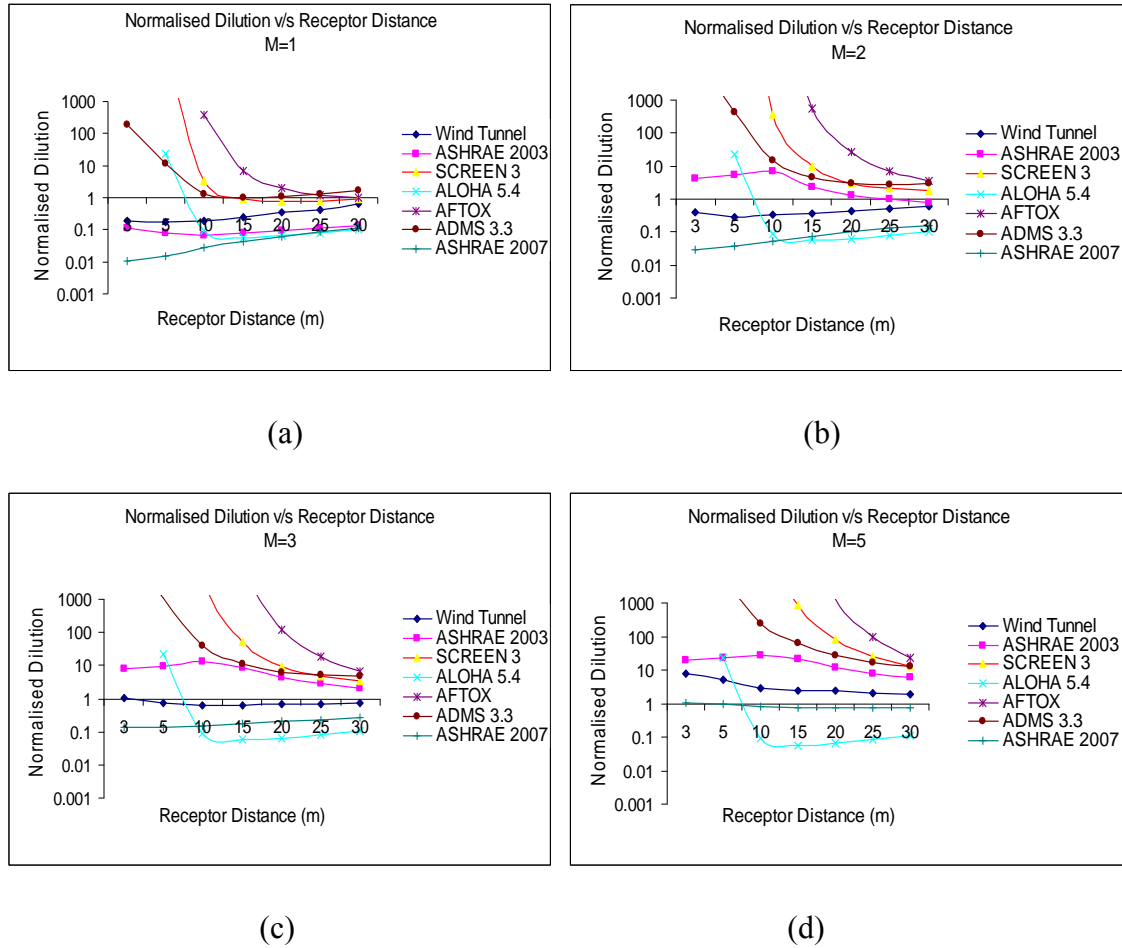

Figure 5.14 Normalised dilution versus receptor distance for stack height of three metres; low-rise building with roof top structure

Discussion: Figure 5.14 shows the convergence of curves tends to start after 20 metres from the stack, while the initial values obtained from AFTOX, SCREEN 3 and ADMS 3.3 are extremely high. Wind tunnel data are almost ten times higher than those from ASHRAE 2003. AFTOX and ALOHA 5.4 produce extremely high and excessively low results respectively; however the former gives higher concentrations at higher stack heights and exhaust momentum while the latter does not show significant change in the dilutions with varying M. ASHRAE 2007 produces very low (conservative) dilutions compared to ASHRAE 2003 and wind tunnel results.

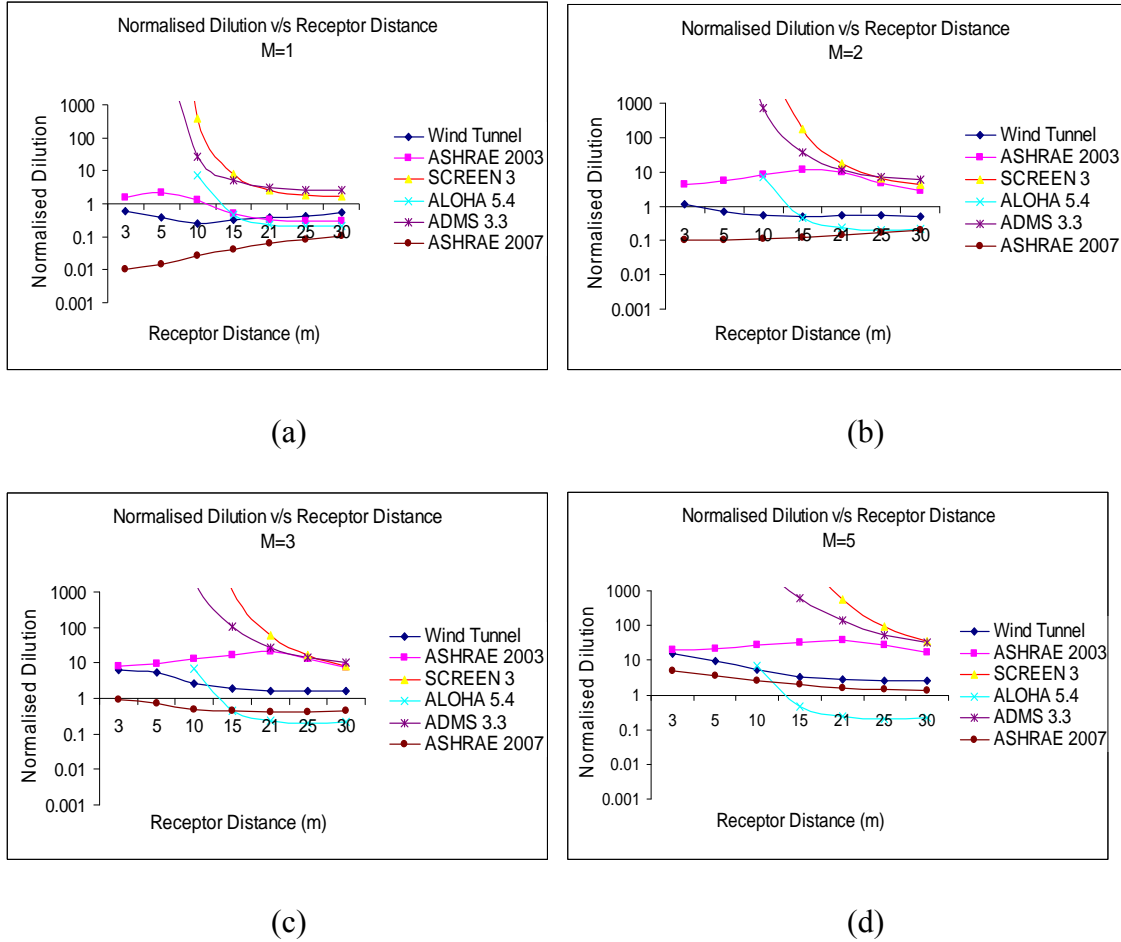

Figure 5.15 Normalised dilution versus receptor distance for a stack height of five metres; low-rise building with roof top structure

Discussion: Figure 5.15 shows that SCREEN 3 and ADMS 3.3 give comparable outputs for distances beyond 18 metres downwind of the stack, while ALOHA, wind tunnel and ASHRAE 2003 results are comparable for lower values of exhaust momentum. However, at higher values of exhaust momentum SCREEN 3 and ADMS 3.3 give very high values (almost 100 times higher) of dilution compared to the wind tunnel data. The ASHRAE 2003 compares well with the wind tunnel data at lower values of M but deviates to quite an extent (almost by 10 times) with increasing values of M. AFTOX does not give any values of concentration. Unlike previous cases, the ASHRAE 2007 results are comparable with wind tunnel and ASHRAE 2003 results for M=5.

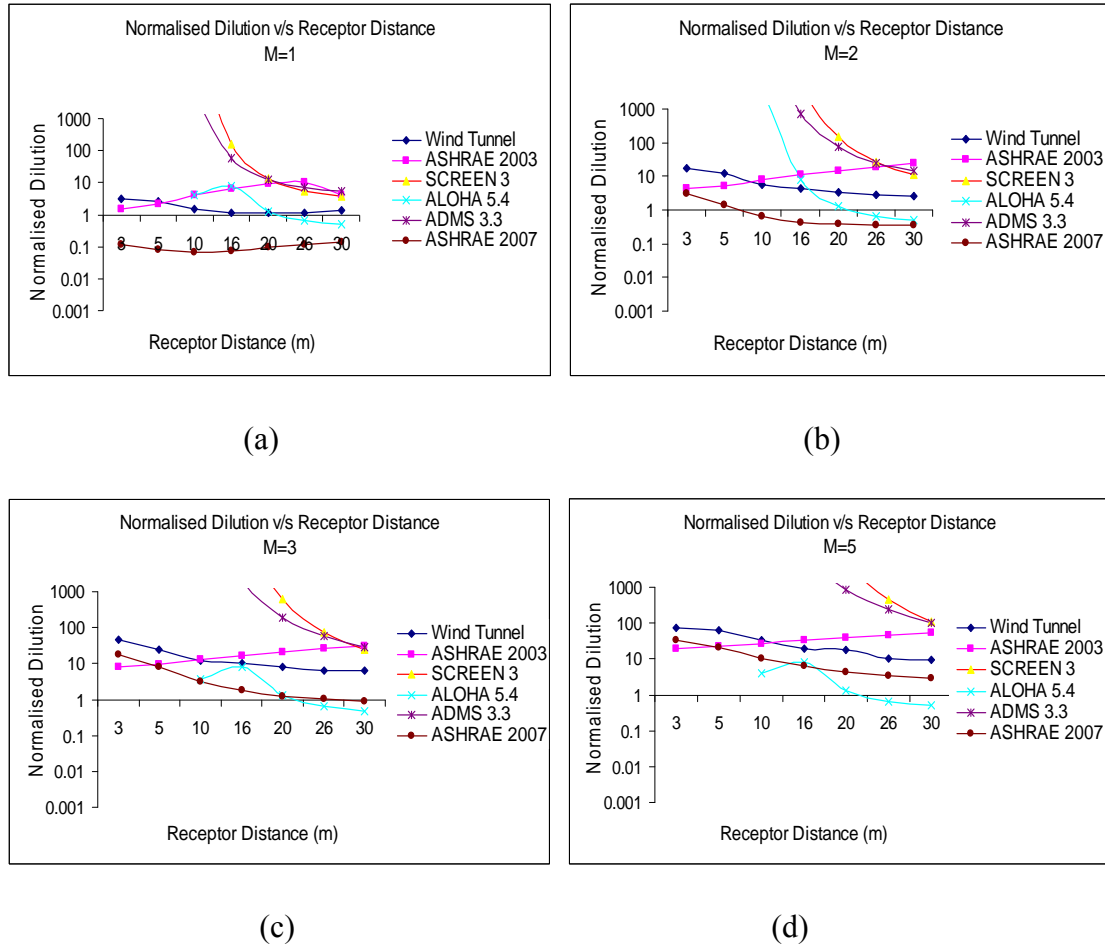

Figure 5.16 Normalised dilution versus receptor distance for a stack height of seven metres; low-rise building with roof top structure

Discussion: SCREEN 3 and ADMS 3.3 give extreme values of normalised dilution for the highest stack – see Figure 5.16. The values are about 100 times more than the wind tunnel data. While wind tunnel and ASHRAE are comparable, ALOHA 5.4 produces very low value of dilution for all cases. It can also be seen from the graphs that ADMS and SCREEN 3 produces higher dilution for the first twenty metres from the stack and converges subsequently, but a similar trend is not observed with the wind tunnel and ASHRAE 2003 values. It is also interesting to note that ASHRAE 2007 values gradually become comparable to wind tunnel results with an increase in exhaust momentum which was never observed in the earlier cases thereby defining its suitability for the given case.

5.5 Case 4: Low-rise Building with Varying Wind Direction

The low-rise building of 15 metres height was also considered for the study of dispersion of effluents by changing the angle of direction of wind to 45 degrees to the horizontal. Even though ASHRAE considers the maximum dilutions at the plume centre line, wind tunnel results for other points compared with the ADMS 3.3 respective values. It should be noted that ADMS 3.3 unlike other models such as AFTOX, SCREEN, ALOHA and ASHRAE, has the option of checking other wind directions. Details of the building are

mentioned below in Table 5.3 and Figure 5.17. The height of stack has been varied from 1 to 7 metres for increasing values of exhaust momentum.

Table 5.3 Building details

| |
|-----------------|
| Height = 15 m |
| Width = 50 m |
| Breadth = 50 m |
| $d_e = 0.6$ m |
| $U_h = 5.4$ m/s |

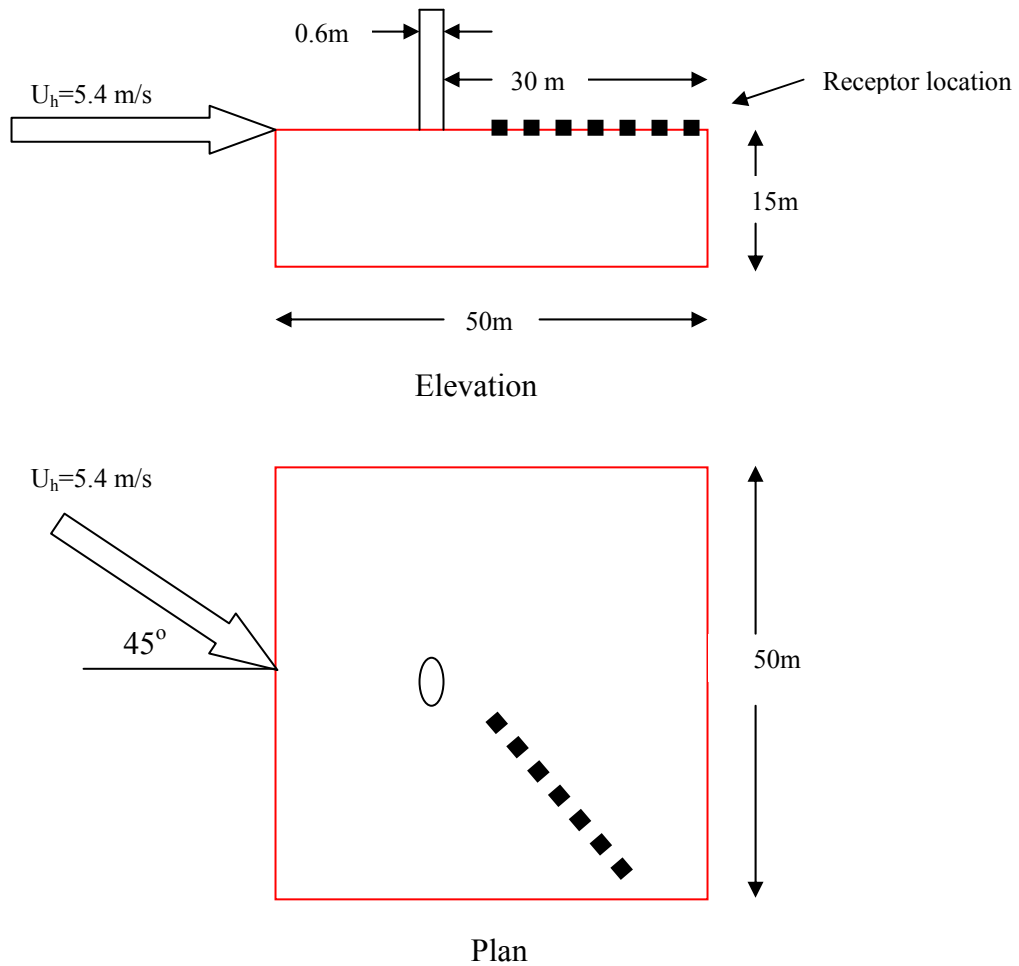

Figure 5.17 Low-rise building with wind direction at 45 degrees

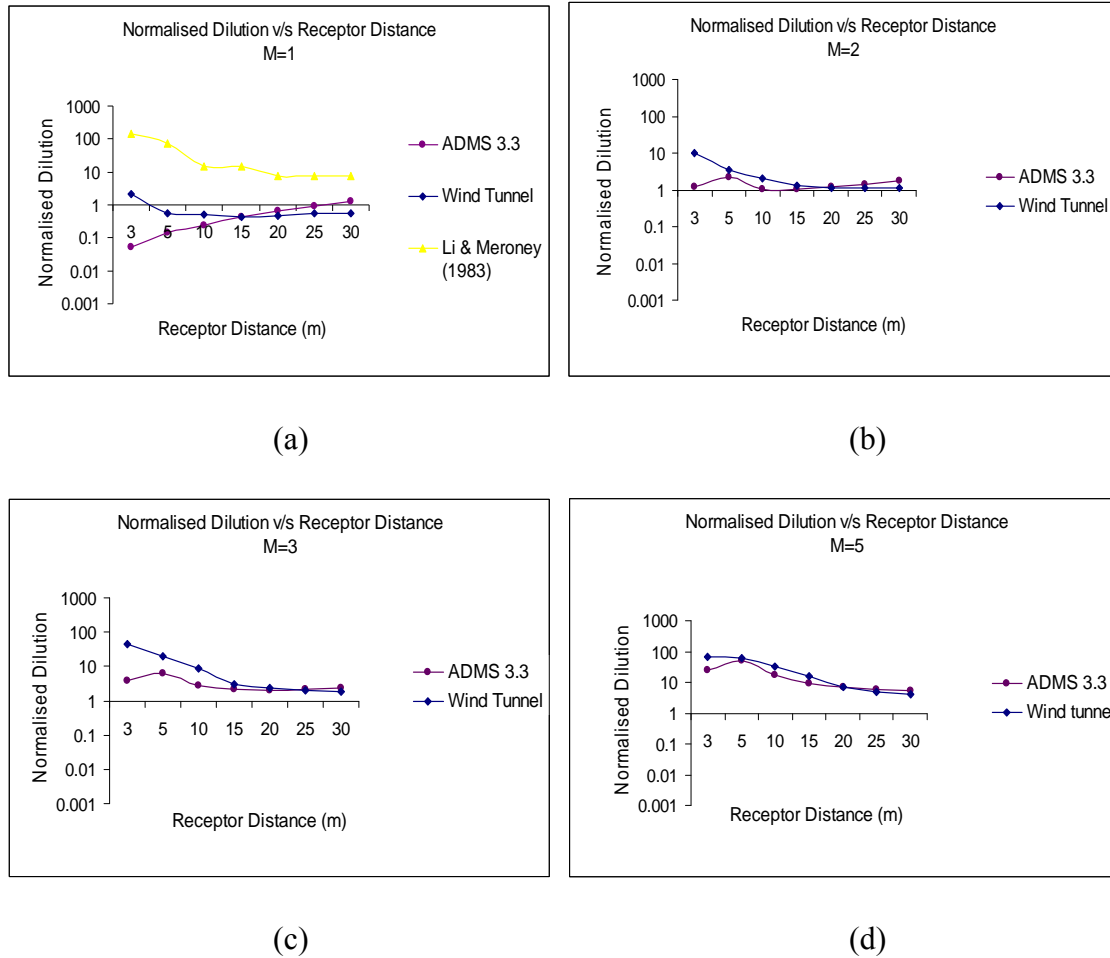

Figure 5.18 Normalised dilution versus receptor distance for a stack height of one metre; 45 degrees azimuth

Discussion: Figure 5.18 shows that for the given stack height of one metre, the wind tunnel and ADMS 3.3 yield comparable results especially for higher values of exhaust momentum and points away from the stack. Wind tunnel data were taken in the direction of the wind on the roof. Li and Meroney (1983) conducted experiments on a building model of 5 cm cube, representing a 100 m tall building in reality and used a flush vent for very low exhaust momentum ($M=0.07$). Although this case is not really comparable with the results of the present study, Li and Meroney's results have been included in Figure 5.18 (a). Expectedly very high dilutions (low concentrations) were found by Li and Meroney (1983).

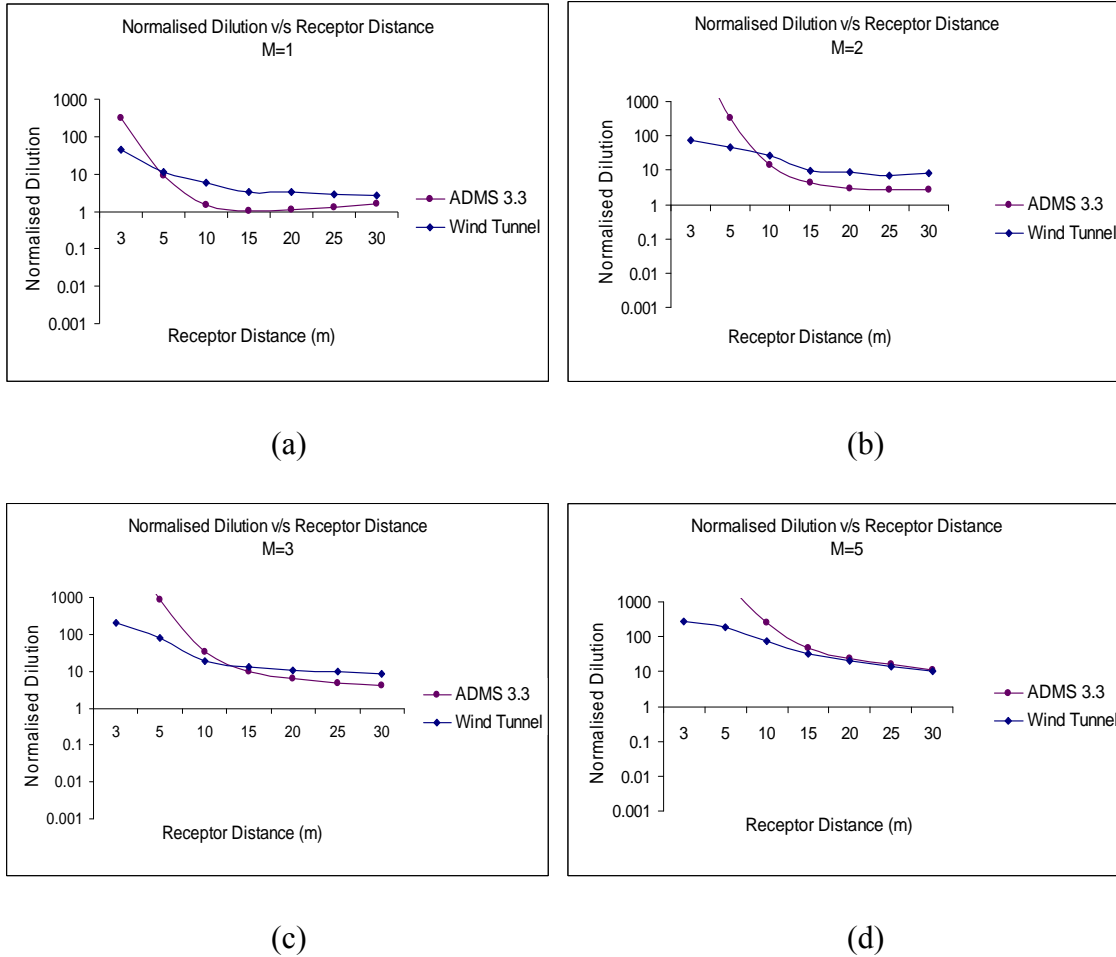

Figure 5.19 Normalised dilution versus receptor distance for a stack height of three metres; 45 degrees azimuth

Discussion: Figure 5.19 shows there is more discrepancy in the dilution values between the Wind tunnel and the ADMS 3.3 results within the first ten metres from the stack, but the curves tend to converge thereafter. This convergence is more dominant in the case of higher exhaust momentum values (M=5). It may also be noted that the dilution values nearer the stack are quite high; ADMS yields about ten times more dilution than the wind tunnel data for the same receptor point.

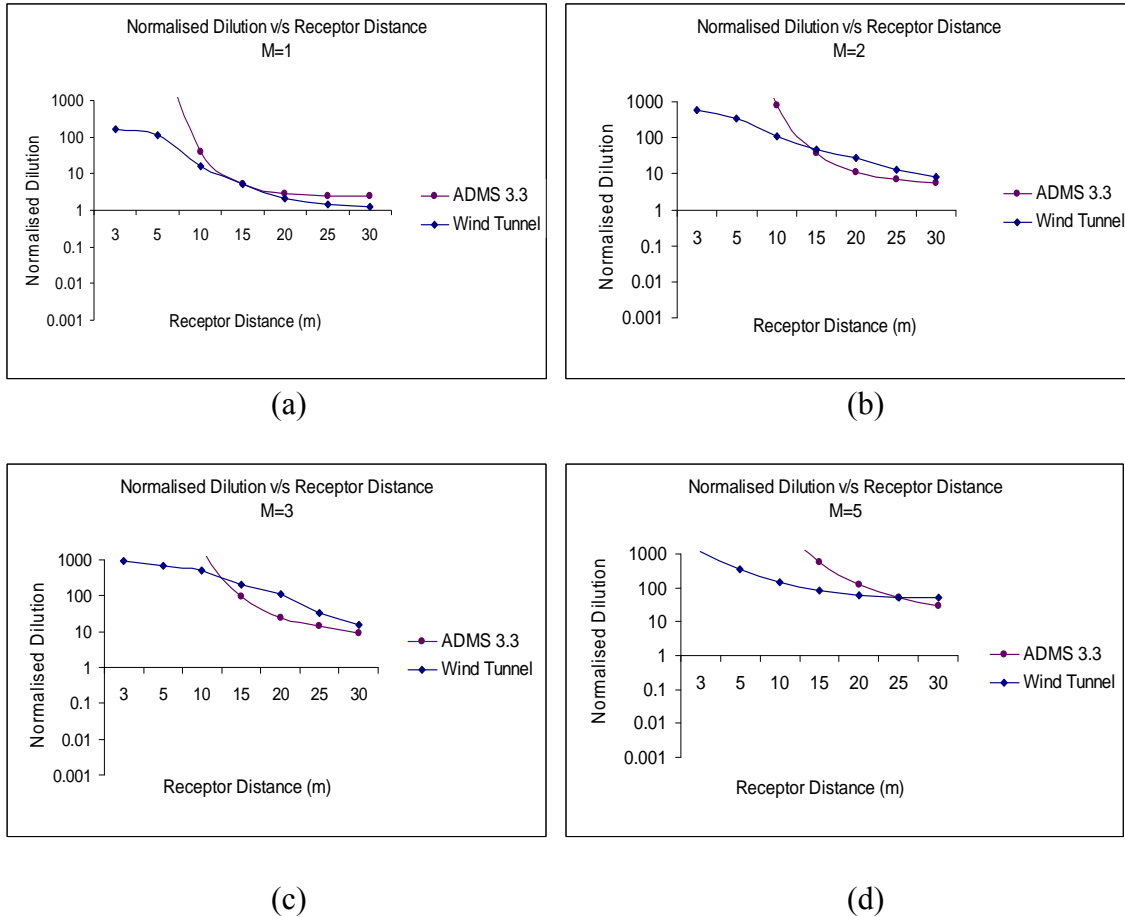

Figure 5.20 Normalised dilution versus receptor distance for a stack height of five metres; 45 degrees azimuth

Discussion: As in previous cases, Figure 5.20 shows discrepancy in the dilution values between the Wind tunnel and the ADMS 3.3 results within the first ten metres from the stack for lower values of M , but the curves tend to converge thereafter. However at $M=5$ the curves intersect at 25 metres away from the stack. In general ADMS 3.3 gives higher values of normalised dilution than the wind tunnel data and is more predominant for higher exhaust momentum values.

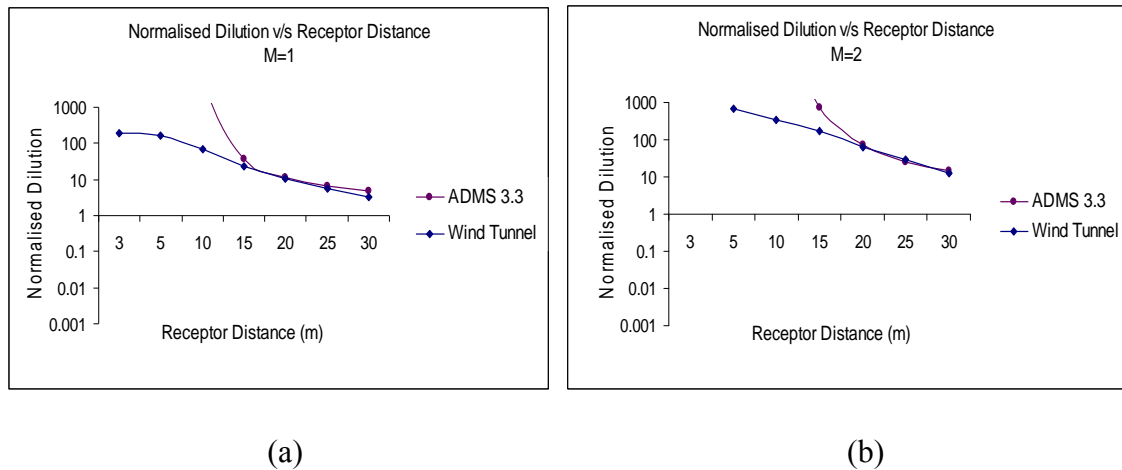

Figure 5.21 Low-rise building with a stack of seven metres height; 45 degrees azimuth

Discussion: Discrepancy exists in the dilution values between the Wind tunnel and the ADMS 3.3 within the first ten metres from the stack for lower values of M, but again, the curves tend to converge thereafter. However at M=2 the curves intersect only at 20 metres away from the stack, following which there is convergence. In general, ADMS 3.3 gives higher values of normalised dilution than the wind tunnel data which is more predominant for higher exhaust momentum values.

5.6 Case 5: Field Data Comparison with ADMS 3.3

During one of the previous IRSST projects conducted jointly by Concordia University and IRSST personnel, field concentration measurements were also taken on the roof of the BE Building and walls of the FG building, by considering the wind flow from the FG building in the direction of the BE building. The BE building is a 13-metre high three-storey building, while the FG building is 50 metres tall and lies upwind of the BE building. A schematic diagram is shown in Figure 5.22. In one case the stack was positioned 4.2 metres from the roof edge of the BE building and in the other case, it was placed 19 metres from the roof edge as shown in Figure 5.22 and 5.24 respectively.

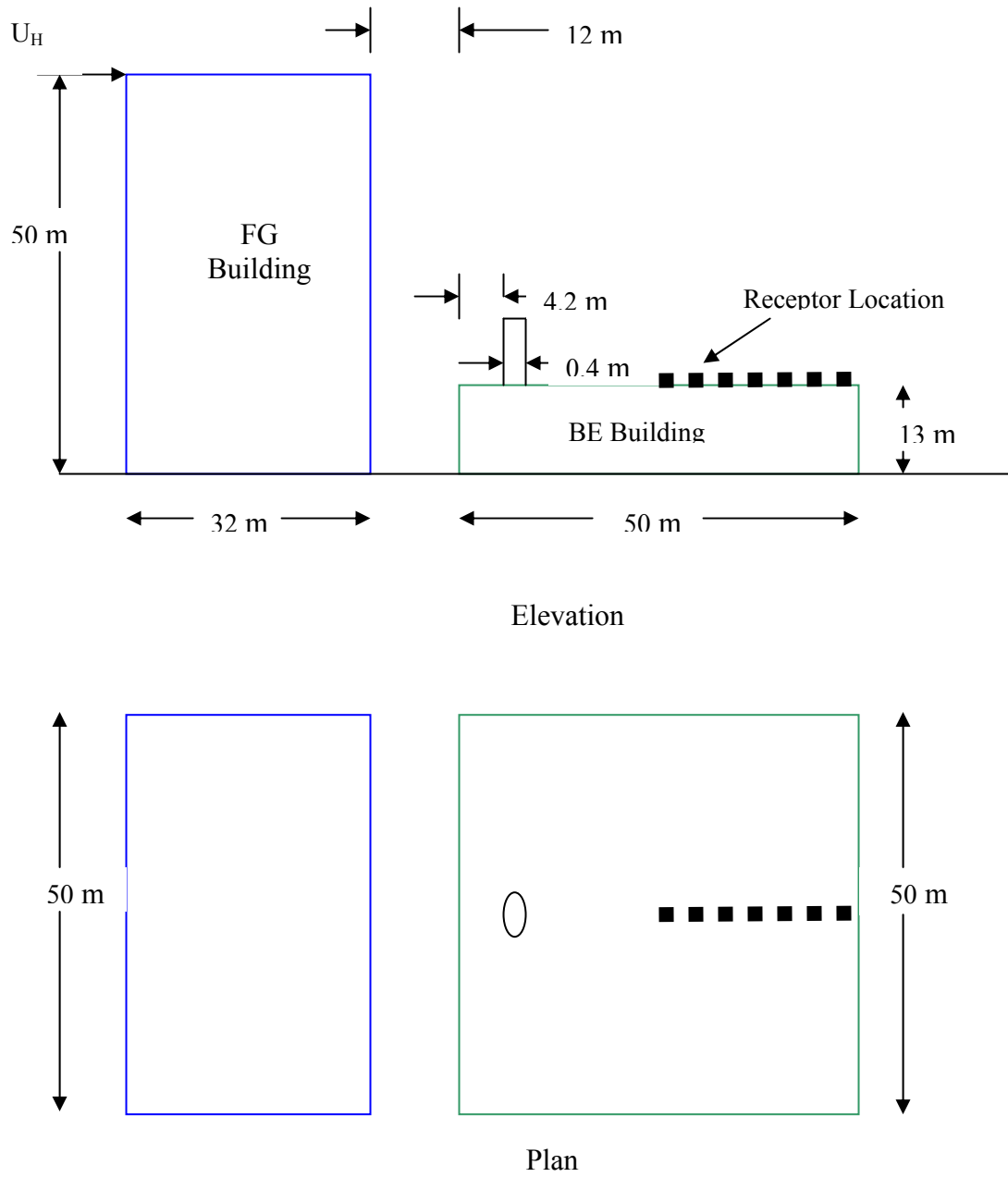

Figure 5.22: FG and BE building with stack and receptor location

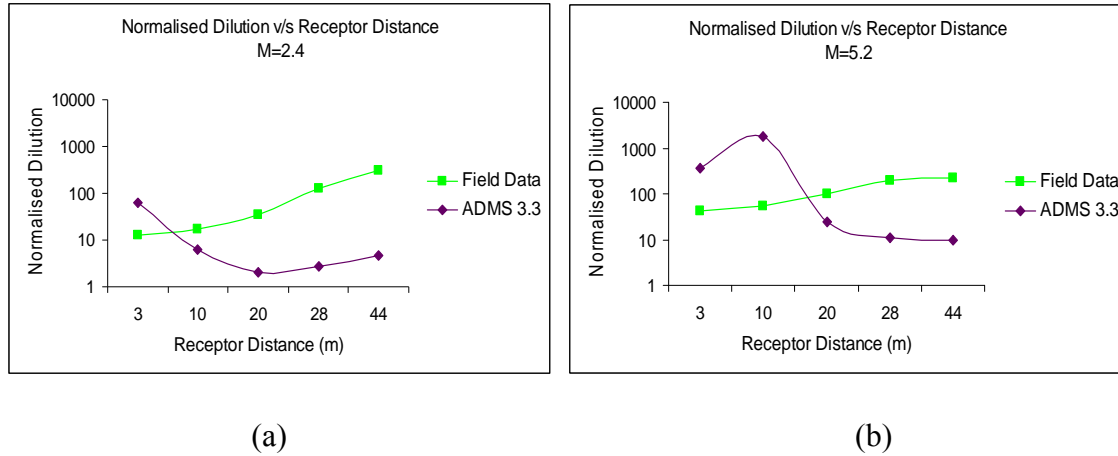
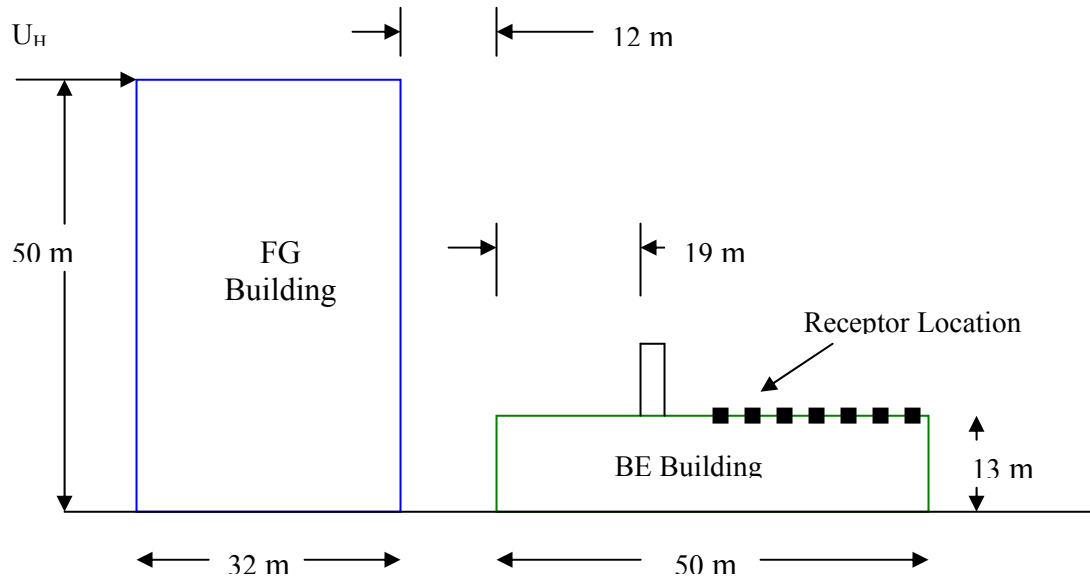

Figure 5.23 Normalised dilution versus receptor distance for a stack height of one metre

Discussion: The measurements were taken on the roof of the BE building and the chemical used is SF₆. The field data shown in Figure 5.23 is about ten times greater than the corresponding ADMS 3.3 values. It is interesting to note that the two curves intersect at a point located just downwind of the stack at lower M, while this point shifts to approximately 15 metres downwind of the stack at higher exhaust momentum. In general, ADMS 3.3 results overestimate dilutions near the stack and underestimate their values at farther receptors.

The same problem has been examined with a change in the stack location – the stack is now located at 19 metres from the edge of the roof, as illustrated in figure 5.24.



Elevation

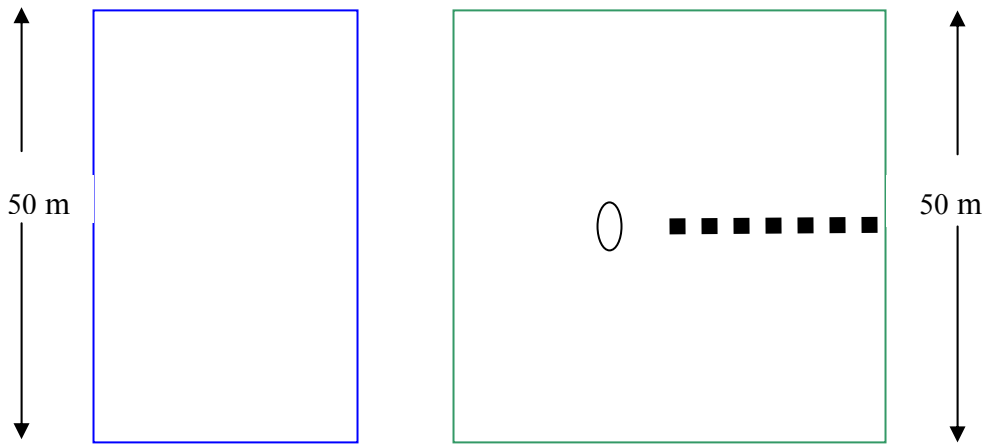

Plan

Figure 5.24: FG and BE building with stack and receptor location

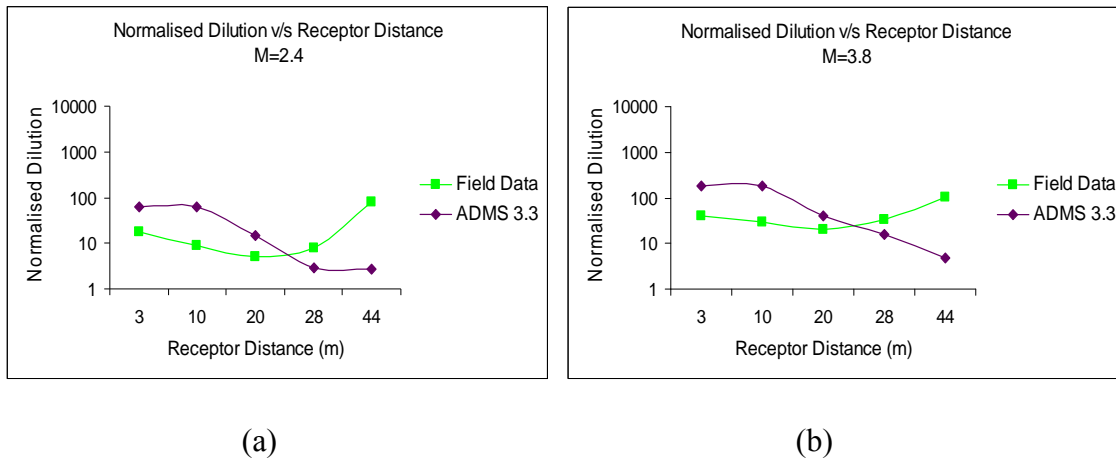

Figure 5.25 Normalised dilution versus receptor distance for a stack height of one metre

Discussion: Figure 5.25 suggests that a point of intersection, where the dilution values obtained by the field test perfectly matched the ADMS results, lies at approximately 25 metres from the edge of the BE building roof. Beyond this point the field data gives higher values compared to the ADMS results, while the opposite trend is observed for points less than 25 metres irrespective of variations of exhaust momentum. However the dilutions are lower for lower exhaust momentum compared to higher values of M.

The next Chapter presents a set of conclusions that can be drawn from this study and also highlights some of the points that can be extended for further research and future scope.

Chapter-6

Conclusions and Future Scope

6.1 General

The conclusions have been based on the results that have been obtained from the experiments (field/wind tunnel) and by the use of various EPA models used. Some of the points which can be considered for future study and research have been highlighted.

6.2 Conclusions

In general, irrespective of the model used for calculations, the normalized dilutions tend to be higher with increase in exhaust momentum. This is essentially because for a constant wind velocity as the exhaust velocity increases, the particles get dispersed more easily due to higher discharge rates and hence results in higher dilution values. In addition, higher M values imply higher plume rise permitting greater dilution before the plume intersects the roof region.

All EPA models used in the study (AFTOX, ADMS 3, ALOHA 5.4 and SCREEN 3) are based on the popular Gaussian equations and hence are not suitable for short range dispersion problems involving a few meters within the vicinity of the building. As a result it is observed that a majority of the models give a very high value of dilution just downwind of the stack, but after about 10 meters from the stack location the curves from the various models tend to converge. With the exception of ADMS 3.3, most of the EPA models used in this study cannot be used to get reliable dilution predictions. It is worth noting that ADMS 3.3 unlike other models can also model the change in angle of the blowing wind.

AFTOX (air force toxic chemical) model gives extremely high values of normalized dilution and especially for higher exhaust momentum or greater stack height the model does not give any concentration values near the stack location, clearly indicating its unsuitability for the present problem.

In both low-rise and high-rise buildings without roof top structures, the roof dilutions found by all methods (ASHRAE 2003 and 2007, wind tunnel, and EPA models), increase with an increase in the stack height. This is due to the increase in wind velocity with height since this helps disperse the effluents in the air and hence results in higher dilutions. ASHRAE 2003 and wind tunnel data give comparable results for higher exhaust momentum values but tend to deviate for lower values of M. In fact the wind tunnel values are about ten times higher than the ASHRAE results.

Furthermore, the ASHRAE results were found to be more appropriate for the given problem since they predict nearly comparable dilutions with those obtained from the wind tunnel and are also suited for near field dispersion problems. In contrast the EPA models are more suitable for far field dispersion problems involving larger distances

since they produce extreme values of dilution near the stack and tend to converge with the ASHRAE and wind tunnel data only with increasing distances.

It is interesting to note that ASHRAE 2007 predicts lower dilutions downwind of the stack compared to ASHRAE 2003 and other models in cases involving low-rise or high-rise buildings without roof top structure. However while considering the effects of the roof top structure on the low-rise building, dilutions found by ASHRAE 2007 are lower for low stack height and smaller values of M but gradually become comparable to wind tunnel values for higher stack heights.

Even though the calculations per ASHRAE 2007 are much simpler than the 2003 version, the dilutions are much lower in most cases suggesting a high receptor concentration of effluents. The comparisons made in this study shed doubts in the validity of ASHRAE 2007 results at least for some cases.

While considering the change in the wind direction, striking similarity in results were observed between the wind tunnel and ADMS 3.3 results for lower values of “ M ” and lower stack heights. However this similarity ceases to exist with an increase in stack height and for higher exhaust momentum, where ADMS produces 10 times more dilutions than wind tunnel data, thus proving the incapability of ADMS 3.3 for greater stack heights.

A general conclusion that can be drawn is that most of the EPA models are suitable only for lower stack heights (say less than 3 meters) and lower exhaust momentum, (say $M < 3$), since they compare well with the wind tunnel/field data, for these cases.

Regarding the measurements taken on the roof of the BE building, owing to building downwash caused by the presence of the FG building in the upwind of the BE building, the dilutions were found to be much higher when the stack was closer to the edge of the roof of the BE building. In general the field data produced about 10 times higher dilution values compared to the ADMS 3.3 results for both cases of stack location. Finally to conclude, a brief summary of the performance of all models used in this study, is presented in Table 6.1.

Table 6.1 Brief summary of performance of the models examined

| Model | Important Features | Limitations |
|--------|--|---|
| ADMS | <ul style="list-style-type: none"> i. Models building and stack effects for various stability conditions. ii. Models various chemical releases. iii. Models the effect of wind direction. iv. Uses Gaussian equations for determining concentrations v. Estimates concentrations at a point or as contours, representing an area. | <ul style="list-style-type: none"> i. Gives higher dilutions than experimental results within first 10 m from stack. ii. Cannot model the effect of roof top structure. |
| SCREEN | <ul style="list-style-type: none"> i. Models single and multiple stack releases. ii. Models various chemical releases. iii. Uses Gaussian equations for determining concentrations. | <ul style="list-style-type: none"> i. Cannot model building and stack downwash effects ii. Cannot model the effect of roof top structure. iii. Unsuitable for near-field dispersion evaluations iv. Over estimates concentration of pollutants. v. Predicts very high initial dilutions (within first 10m from stack). vi. Cannot model the change in wind direction. |
| AFTOX | <ul style="list-style-type: none"> i. Models point or area sources ii. Simulates all stability conditions iii. Models up to 130 different chemicals. iv. Uses Gaussian equations for determining concentrations. | <ul style="list-style-type: none"> i. Effect of roof top structure cannot be modelled ii. Unsuitable for near-field dispersion within 10 m from effluent source. iii. Cannot model the effect of building downwash and roof top structure. iv. Cannot model the change in wind direction. |
| ALOHA | <ul style="list-style-type: none"> i. Models the effluents by using Gaussian equations or by considering it as a heavy gas. ii. Models effluent discharge during explosions and fires. iii. Models single and multiple stack releases. | <ul style="list-style-type: none"> i. Cannot model the effect of building downwash and roof top structure. ii. Cannot model the change in wind direction. iii. Unsuitable for dispersion within 15 m from the effluent source. |
| ASHRAE | <ul style="list-style-type: none"> i. Uses Gaussian equations to model effluent dispersion. ii. Applies to short-term releases and near field dispersion. iii. Considers building and stack downwash effects. iv. Gives separate formulations for capped and uncapped stacks. v. Models the effect of roof top structure | <ul style="list-style-type: none"> i. ASHRAE 2007 gives higher concentrations than ASHRAE 2003. ii. Does not consider the effects of neighbouring buildings in the vicinity of the pollutant source. iii. Different geometries of buildings and terrain conditions not considered in the formulations. |

6.3 Scope for Future Work

Additional research is necessary to improve the ASHRAE model predictions for different building geometries, upstream terrain roughness and wind directions, particularly regarding the ASHRAE 2007 approach. ADMS 3.3 is the most promising from the so-called EPA recognised models, but the range of its application should be established more clearly by comparisons with additional experimental results and field data.

REFERENCES

ADMS 3 User Guide (2004), Cambridge Environmental Research consultants Limited, Cambridge, UK

AFTOX User Guide (1993), US Environmental Protection Agency, USA

Ahmadi G and Tian L (2007) "Particle deposition in turbulent duct flows—comparisons of different model predictions", *Journal of Aerosol Science* Volume 38, Issue 4, Pages 377-397

ALOHA User manual (2006), US Environmental Protection Agency.

ASHRAE (1993) Chapter 14, "Airflow around Buildings", *ASHRAE Applications Handbook*, American Society of Heating, Refrig. And Air-Cond. Eng., Inc., Atlanta.

ASHRAE (1997) Chapter 15, *Airflow around Buildings*, *ASHRAE handbook—1997 fundamentals*, American Society of Heating, Refrigerating and Air-Conditioning Engineering, Atlanta, USA

ASHRAE (1999) Chapter 43, "Building Air Intake and Exhaust Design", *ASHRAE Applications Handbook* American Society of Heating, Refrig. and Air-Cond. Eng., Inc., Atlanta.

ASHRAE (2003) Chapter 44, "Building Air Intake and Exhaust Design", *ASHRAE Applications Handbook*, American Society of Heating, Refrig. And Air-Cond. Eng., Inc., Atlanta.

ASHRAE (2005) Chapter 16, *Airflow around Buildings*, *ASHRAE handbook fundamentals*, American Society of Heating, Refrigerating and Air-Conditioning Engineering, Atlanta, USA

ASHRAE (2007) Chapter 44, "Building Air Intake and Exhaust Design", *ASHRAE Applications Handbook*, American Society of Heating, Refrig. And Air-Cond. Eng., Inc., Atlanta

Bosanquet, C.H. and Pearson, J.L. (1936) "The spread of smoke and gases from chimneys", *Trans. Faraday Soc.*, 32:1249, 1936

Briggs. (1984) "Plume rise and buoyancy effects", in *Atmospheric Science and Power Production*. Randerson. Ed, U.S. Department of energy D.O.E./TIC-27601 (DE 84005177), Washington, D.C.

Carruthers D., Riddle A., Sharpe A., McHugh C., Stocker J. (2004) "Comparison between FLUENT and ADMS for atmospheric dispersion modelling", *Atmospheric Environment*, 38, 1029-1038

Colls, J. (2002) "Air Pollution", Second Edition, Spon press, London, UK

Dunkerley, F., Hall, D.J., Spanton, A.M., Bennett, M and Griffiths, R.F. (2000) "An intercomparison of the AERMOD, ADMS and ISC Dispersion Models for Regulatory Applications", *Proceedings of the Seventh International Conference on Harmonisation within Atmospheric Dispersion Modelling for Regulatory purposes*, Italy

Environmental Protection Agency (1995) "User's Guide for the Industrial Source Complex (ISC3) Dispersion Models (revised) Volume II - User Instructions", EPA-454/b-95-003a, U.S. Environmental Protection Agency, Research Triangle Park, NC

Gifford, F. A., (1966) "Use of routine meteorological observations for estimating atmospheric dispersion", *Nuclear Safety*. Vol. 2, 47-51

Flow Components and Control Equipment brochure (2007), Matheson Tri-Gas, USA

Gupta, A. (2008) "Physical modelling of the downwash effect of roof top structures on plume dispersion", PhD Thesis, Department of BCEE, Concordia University, Canada

Franck, N and Jensen, M (1963) "Model scale tests in Turbulent wind: Part I, Phenomena dependent on the wind speed: Shelter at houses- Dispersal of smoke. Copenhagen: The Danish technical press, pp-102.

Halitsky J (1963) "Gas Diffusion near Buildings", *ASHRAE Transactions*, Vol.69, pp-464-484

Higson, H. L., Griffiths, R.F., Jones, C.D. and Hall, D.J. (1994) "Concentration measurements around an isolated building: a comparison between wind tunnel and field data", *Atmospheric Environment*, Vol. 28, No. 11, pp. 1827-1836.

Lamb, B and Cronn, D. (1986) "Fume hood exhaust reentry into a chemistry building", *Journal of the American Industrial Hygiene Association*, Volume 47 (2), pp 115-123.

Li, W.W and Meroney, R.N (1983) "Gas Dispersion near a cubical model building. Part I Mean concentration measurements", *Wind Engineering and Industrial Aerodynamics*, vol. 12, pp-15-33, 1983.

- Martin, J.E., (1965) "The correlation of Wind tunnel and field measurements of gas diffusion using Krypton-85 as a tracer", PhD thesis. Department of Health Science, University of Michigan.
- Mc Elroy, J.L. and Pooler, F. (1968) "The St Louis dispersion study", US Public health service, National Air Pollution Control Administration.
- Meroney, R.N. (1982) "Dispersion enhancement models in turbulent diffusion near buildings", Engineering Meteorology, Chapter-11, Elsevier, pp-490-496.
- Meroney, R. N., Leitl, B., Rafailidis, S. and Schatzmann, M. (1999) "Wind-tunnel and numerical modelling of flow and dispersion about several building shapes," Journal of Wind Engineering and Industrial Aerodynamics, 333-345.
- Pasquill, F. (1966) "Lagrangian similarity and vertical diffusion from a source at ground level", Quarterly Journal of the Royal Meteorological Society, Vol. 92, pp 185-192.
- Peterson, R and Carter, J. (2000) "ISC PRIME versus Wind Tunnel observations for Multi-Tiered, sloped, porous structures", Seventh conference on air quality modelling, EPA, USA
- Quinn A.D, Wilson M, Reynolds A, Couling S.B, Hoxey.P (2001) "Modelling the dispersion of aerial pollutants from agricultural buildings - an evaluation of computational fluid dynamics(CFD)", Computers and Electronics in Agriculture, Volume 30, Issues 1-3, February 2001, Pages 219-235
- Saathoff, P., Stathopoulos T and Wu, H (1996) "Dilution of exhaust gases from rooftop stacks-Comparison of Wind tunnel data with full-scale measurements", Proceedings of the ninth Joint conference on Applications of Air Pollution Meteorology, AMS/AWMA, Atlanta 341-345.
- Schulman and Scire, J. (1991) "The effect of stack height, exhaust speed, and wind direction on concentrations from a rooftop stack", ASHRAE Transactions, volume 97, pp 573-582 part 2.
- Scorer R.S. (1968) "Air Pollution", First edition, Pergamon Press, UK
- SCREEN 3 User Guide (1995), U.S Environmental Protection Agency, Office of Air Quality Planning and Standards Emissions, monitoring and analysis division, USA.

Snyder W.H. (1981) "Guidelines for fluid modelling of atmospheric diffusion", EPA Office of Air Quality, Planning and Standards, Research Triangle Park, NC, EPA-600/8-81-009

Stathopoulos T. and Li Y. (1998) "Computational evaluation of pollutant dispersion around buildings: Estimation of Numerical errors", *Journal of Wind engineering and Industrial Aerodynamics* 77& 78, 619-630

Stathopoulos T., Lazure L. and Saathoff P. (1999) "Tracer gas reingestion of Building Exhaust in an Urban Environment", IRSST research report R-213 Institut de recherche Robert-Sauvé en santé et en sécurité du travail, Montreal, Canada

Stathopoulos T., Lazure L., Gupta A. and Saathoff P. (2004) "The effect of stack height, stack location and roof top structures on air intake contamination", IRSST research report R-213 Institut de recherche Robert-Sauvé en santé et en sécurité du travail, Montreal, Canada

Sutton, O.G. (1947) "The problem of diffusion in the lower atmosphere", *QJRMS*, 73:257.

Wang L, Parker D, Parnell C, Lacey R, Shaw B (2006) "Comparison of CALPUFF and ISCST3 models for predicting downwind odour and source emission rates", *Atmospheric Environment*, Volume 40, Issue 25, August 2006, 4663-4669.

Wilson, D (1979) "Flow patterns over flat-roofed buildings and application to exhaust stack design", *ASHRAE Transactions*, 85, part 2, 284-295.

Wilson, D J and Chui, E. (1985) "Influence of Exhaust velocity and wind incidence angle on dilution from roof vents", *ASHRAE Transactions*, 91 (2B) 1693-1706.

Wilson, D J and Chui, E. (1987) "Effect of Turbulence from upwind buildings on dilution of exhaust gases", *ASHRAE Transactions*, 93 (2) 2186-2197.

Wilson, D.J. and Lamb, B., (1994) "Dispersion of exhaust gases from roof level stacks and vents on a laboratory building", *Atmospheric Environment*, 28, 3099-3111.

Wilson, D.J., Fabris, I., Chen, J. and Ackerman, M. (1998) "Adjacent building effects on laboratory fume hood exhaust stack design", *ASHRAE Research Report 897*, American Society of Heating and Refrigerating and Air-conditioning Engineers, Atlanta

Wollenweber, G. C. and Panofsky, H. A. (1989) "Dependence of Velocity Variance on Averaging Time", *Boundary-Layer Meteorology*, vol. 47, 205-215.

APPENDIX A

Grid for Low-rise Building showing the Location of Stack and Receptor points

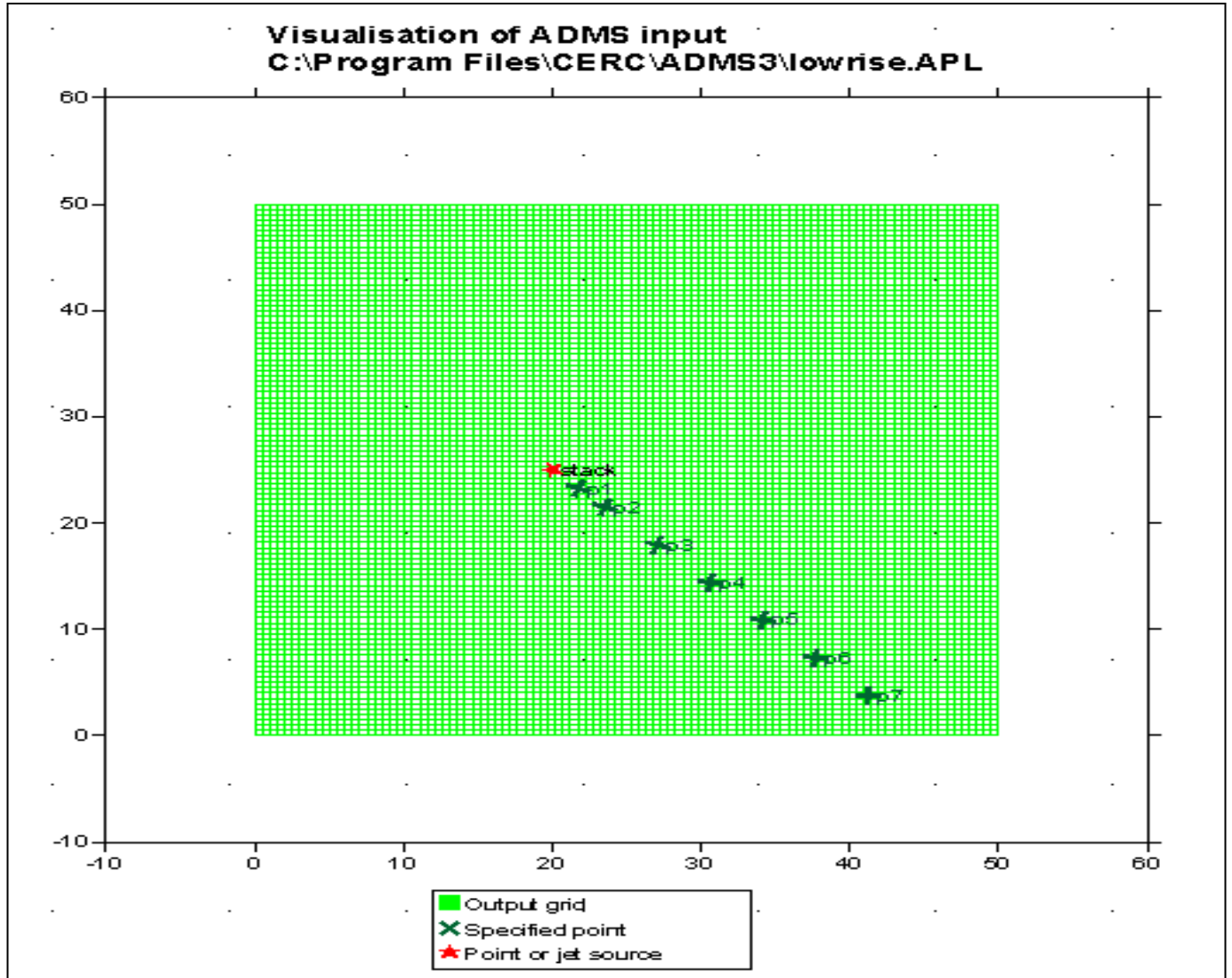

Figure A 1 Grid showing the Plan of Low-rise Building (output file), ADMS 3.3

Discussion: Figure A 1 shows a grid of 50 X 50 meters which constitute the plan of the low-rise building. It also depicts the location of the stack and the grid points that are located at 45 degrees to the horizontal. ADMS is extremely “user-friendly” and represents the input and output points pictorially.

Contour plot for stack height of 3 meters located on Building of 15 metres height

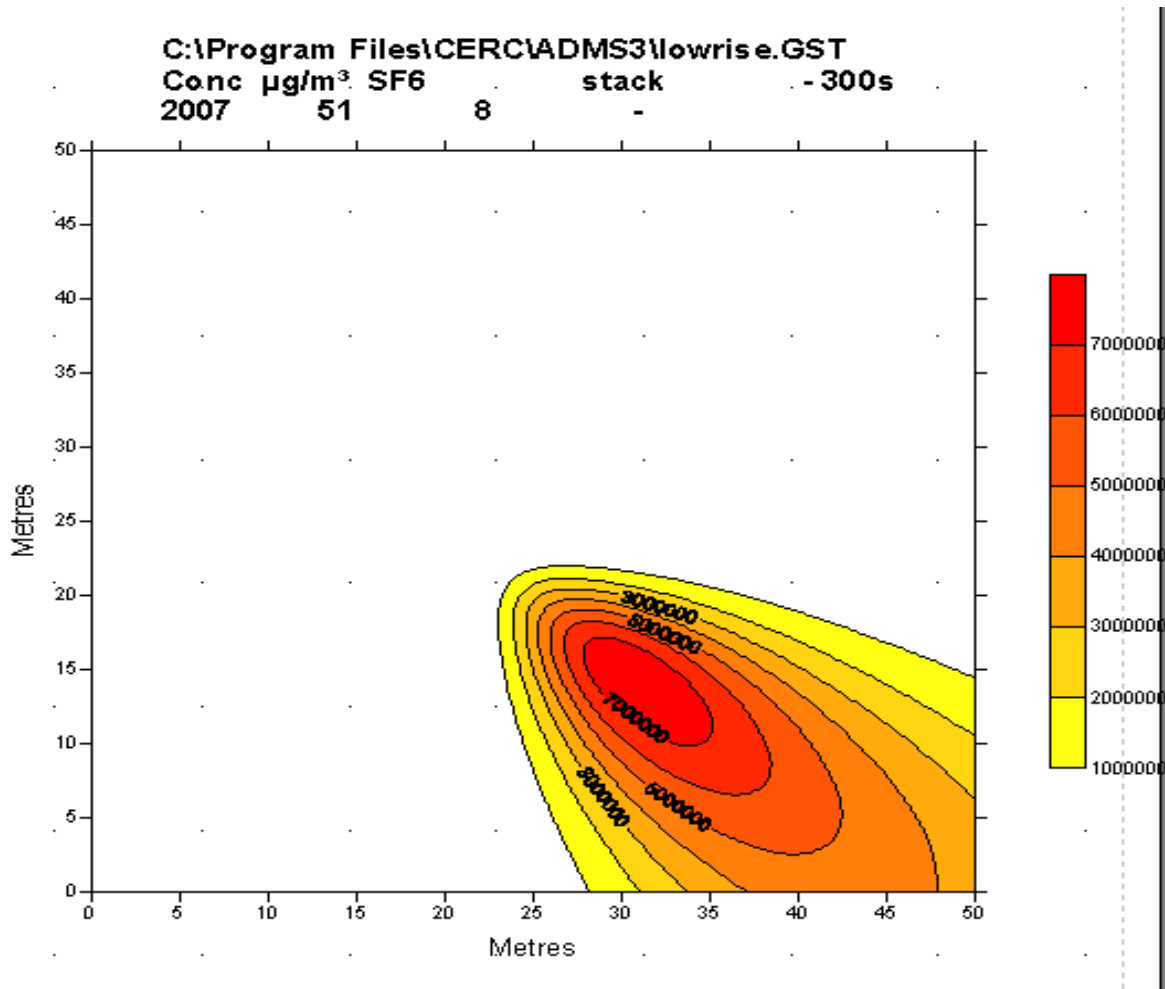

Figure A 2 Grid showing contour for a Low-rise Building (output file), ADMS-3.3

Discussion: Figure A 2 shows a grid of 50 X 50 meters which constitute the plan of the low-rise building. It also depicts the output in the form contour plot. In this figure the low-rise building has the receptor locations at 45 degrees to the horizontal. The concentrations are given in micro grams per second and can be identified by various colours.

Grid of 50 x 50 meters for Low-rise Building showing the Location of Stack and Receptor points

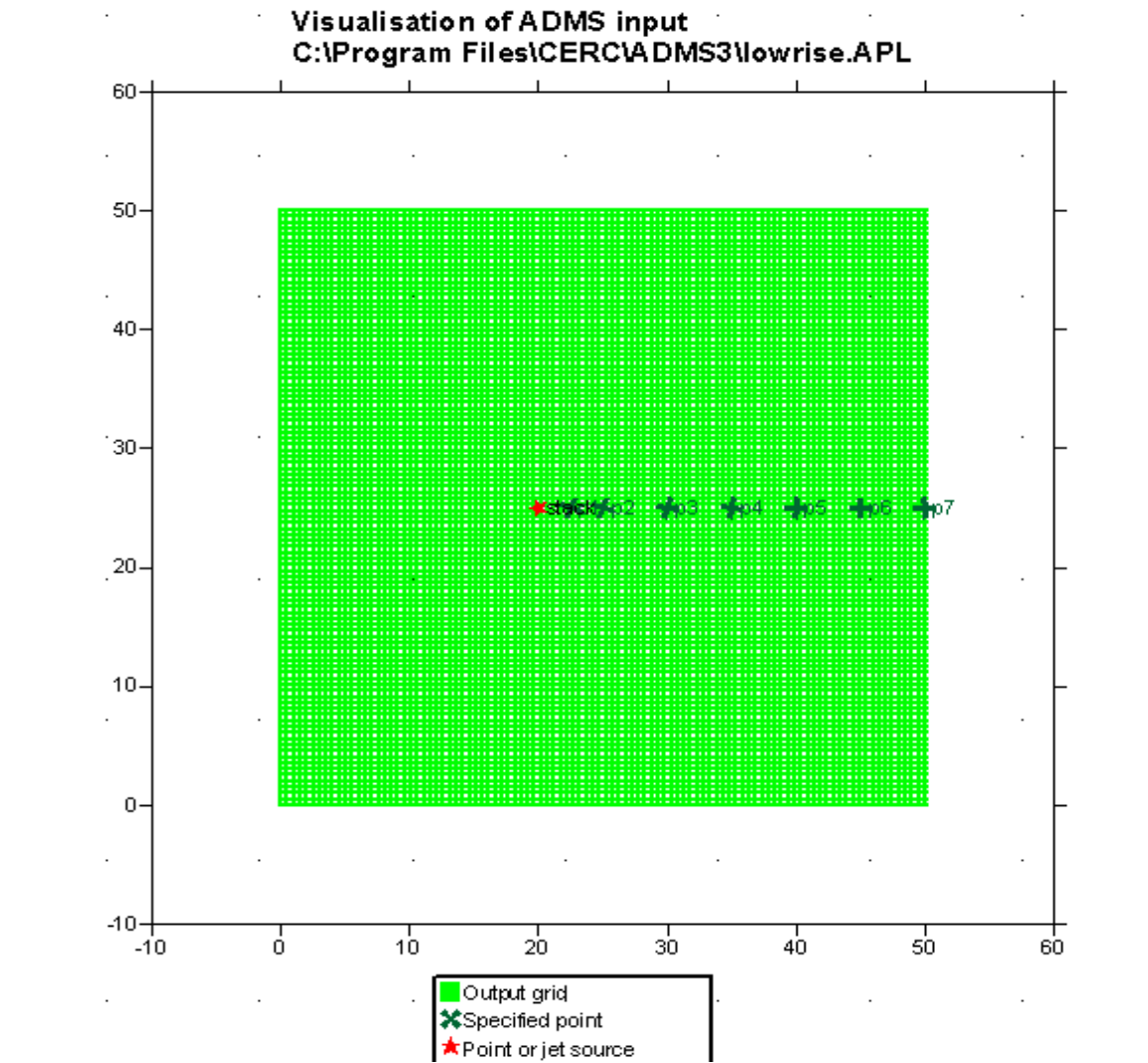

Figure A 3 Grid showing the plan of Low-rise Building, stack and Receptor location

Discussion: Figure A 3 shows a grid of 50 X 50 meters which constitute the plan of the low-rise building. The location of the stack and the grid points are also shown, which are in the direction of the wind.

Contour Plot for Stack height of 3 meters located on Building of 15 meters height

Figure A 4 Grid showing the contour plot for a Low-rise Building with stack of 3 meters height

Discussion: Figure A 4 shows a grid of 50 X 50 meters which constitute the plan of the low-rise building. It also depicts the output in the form contours plot. In this figure the low-rise building has the receptor locations in the direction of wind. It can be noticed that the concentration of the effluents reduces gradually with distance away from the stack.

APPENDIX B

Sample Input and Output for a Low-rise Building

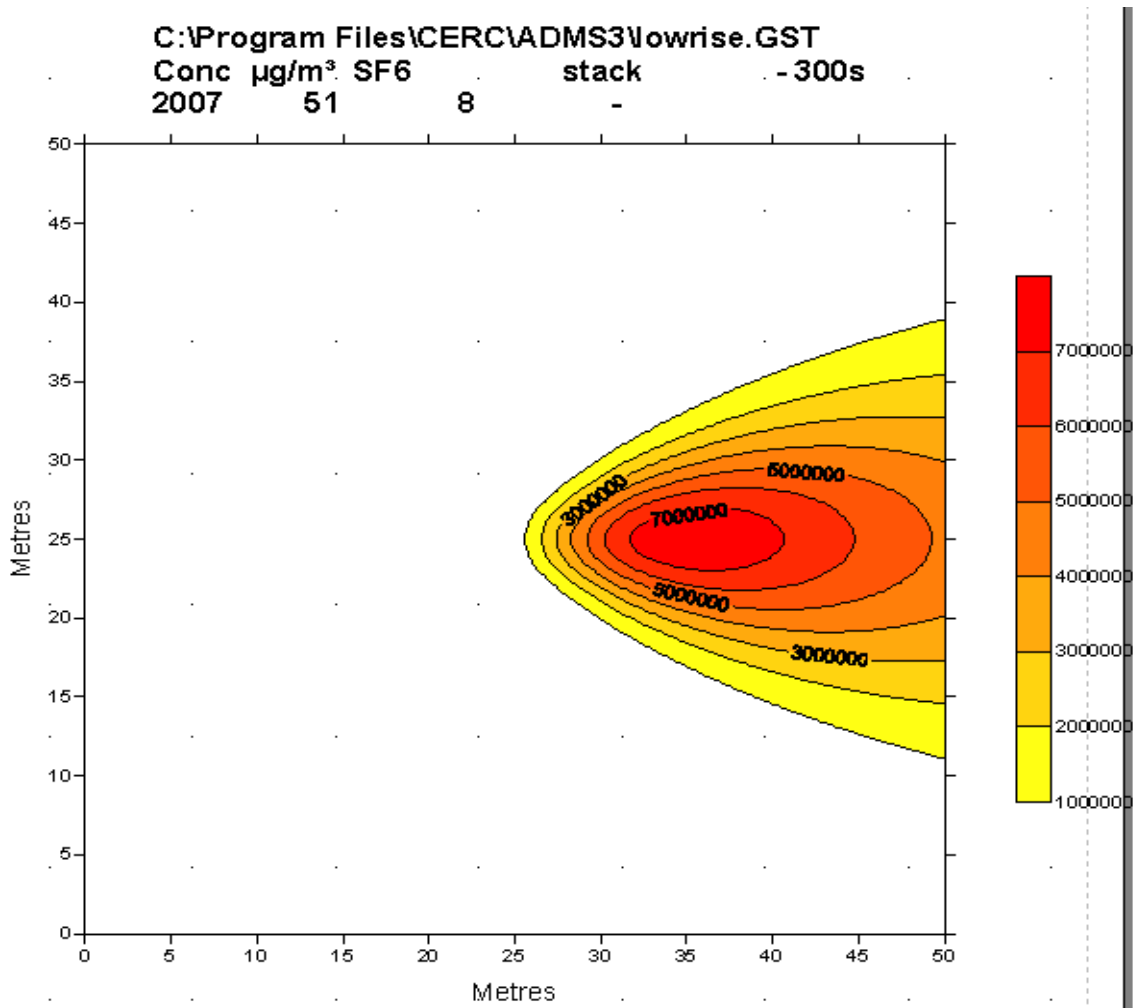
```

***** SCREEN3 MODEL *****
***** VERSION DATED 96043 *****

ENTER TITLE FOR THIS RUN <UP TO 79 CHARACTERS>:
bodhi

ENTER SOURCE TYPE: P      FOR POINT
                   F      FOR FLARE
                   A      FOR AREA
                   U      FOR UOLUME

ALSO ENTER ANY OF THE FOLLOWING OPTIONS ON THE SAME LINE:

  N      - TO USE THE NON-REGULATORY BUT CONSERVATIVE BRODE 2
           MIXING HEIGHT OPTION.
  nn.n   - TO USE AN ANEMOMETER HEIGHT OTHER THAN THE REGULATORY
           <DEFAULT> 10 METER HEIGHT.
  SS     - TO USE A NON-REGULATORY CAVITY CALCULATION ALTERNATIVE
Example - PN 7.0 SS <entry for a point source>

ENTER SOURCE TYPE AND ANY OF THE ABOVE OPTIONS:
P
ENTER EMISSION RATE <G/S>:
9593
ENTER STACK HEIGHT <M>:
16

```

Figure B 1 INPUT screen of SCREEN 3 software

Figure B 1 shows the Input screen of SCREEN 3 which appears on the computer screen while running.

Input and Output for SCREEN 3

The following section represents a sample input and output file as obtained from SCREEN 3 software. A graphical representation has already been shown in chapter 4 earlier. A low-rise building of 15 meters height with stack height of one meter has been used for the study as shown below:

03/03/07

19:19:35

```

*** SCREEN3 MODEL RUN ***
*** VERSION DATED 96043 ***

```

bodhi

SIMPLE TERRAIN INPUTS:

```

SOURCE TYPE           =          POINT
EMISSION RATE (G/S)   =         9593.00
STACK HEIGHT (M)      =         16.0000
STK INSIDE DIAM (M)   =           .6000
STK EXIT VELOCITY (M/S)=          1.0000
STK GAS EXIT TEMP (K) =         293.0000
AMBIENT AIR TEMP (K)  =         293.0000
RECEPTOR HEIGHT (M) =         15.0000
URBAN/RURAL OPTION    =          URBAN

```

THE REGULATORY (DEFAULT) MIXING HEIGHT OPTION WAS SELECTED.

THE REGULATORY (DEFAULT) ANEMOMETER HEIGHT OF 10.0 METERS WAS ENTERED.

BUOY. FLUX = .000 M**4/S**3; MOM. FLUX = .090 M**4/S**2.

*** STABILITY CLASS 4 ONLY ***
 *** ANEMOMETER HEIGHT WIND SPEED OF 10.00 M/S ONLY ***

 *** SCREEN DISCRETE DISTANCES ***

*** TERRAIN HEIGHT OF 3. M ABOVE STACK BASE USED FOR FOLLOWING DISTANCES ***

| DIST (M) | CONC (UG/M**3) | STAB | U10M (M/S) | USTK (M/S) | MIX HT (M) | PLUME HT (M) | SIGMA Y (M) | SIGMA Z (M) |
|-------------|-------------------|------|---------------|---------------|---------------|-----------------|----------------|----------------|
| DWASH | | | | | | | | |
| 5. | .2009E+05 | 4 | 10.0 | 11.2 | 3200.0 | 11.97 | .80 | .70 |
| NO | | | | | | | | |
| 10. | .5777E+07 | 4 | 10.0 | 11.2 | 3200.0 | 11.97 | 1.60 | 1.40 |
| NO | | | | | | | | |
| 15. | .9495E+07 | 4 | 10.0 | 11.2 | 3200.0 | 11.97 | 2.39 | 2.10 |
| NO | | | | | | | | |
| 20. | .8455E+07 | 4 | 10.0 | 11.2 | 3200.0 | 11.97 | 3.19 | 2.79 |
| NO | | | | | | | | |
| 25. | .6700E+07 | 4 | 10.0 | 11.2 | 3200.0 | 11.97 | 3.98 | 3.49 |
| NO | | | | | | | | |
| 30. | .5230E+07 | 4 | 10.0 | 11.2 | 3200.0 | 11.97 | 4.77 | 4.18 |
| NO | | | | | | | | |

DWASH= MEANS NO CALC MADE (CONC = 0.0)
 DWASH=NO MEANS NO BUILDING DOWNWASH USED
 DWASH=HS MEANS HUBER-SNYDER DOWNWASH USED
 DWASH=SS MEANS SCHULMAN-SCIRE DOWNWASH USED
 DWASH=NA MEANS DOWNWASH NOT APPLICABLE, X<3*LB

 * SUMMARY OF TERRAIN HEIGHTS ENTERED FOR *
 * SIMPLE ELEVATED TERRAIN PROCEDURE *

| TERRAIN HT (M) | DISTANCE RANGE (M) | |
|-------------------|--------------------|---------|
| | MINIMUM | MAXIMUM |
| 3. | 5. | -- |
| 3. | 10. | -- |
| 3. | 15. | -- |
| 3. | 20. | -- |
| 3. | 25. | -- |
| 3. | 30. | -- |

 *** SUMMARY OF SCREEN MODEL RESULTS ***

| CALCULATION PROCEDURE | MAX CONC (UG/M**3) | DIST TO MAX (M) | TERRAIN HT (M) |
|--------------------------|-----------------------|--------------------|-------------------|
| SIMPLE TERRAIN | .9495E+07 | 15. | 3. |

 ** REMEMBER TO INCLUDE BACKGROUND CONCENTRATIONS **

APPENDIX C

Input and Output from AFTOX

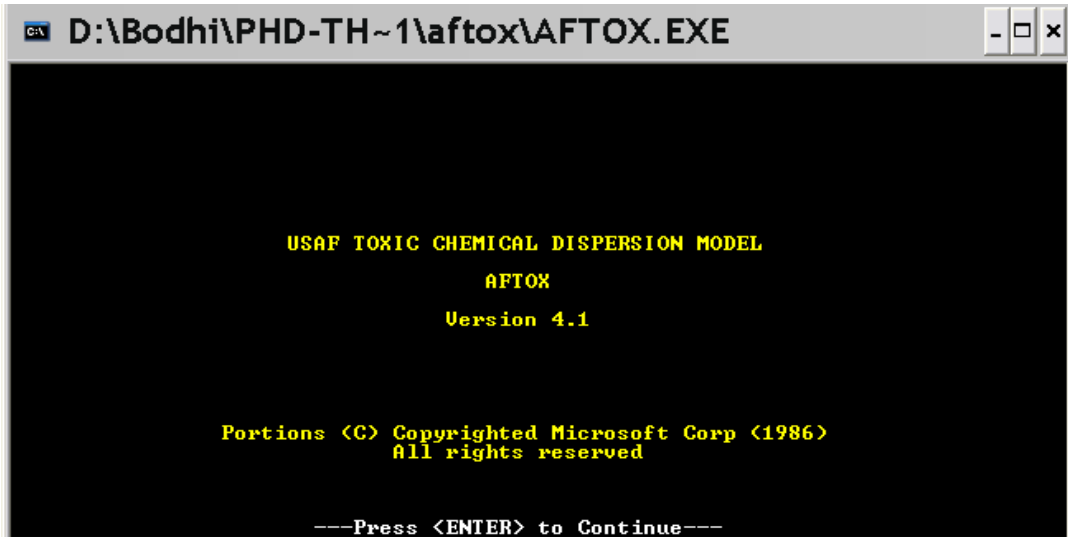

(a)

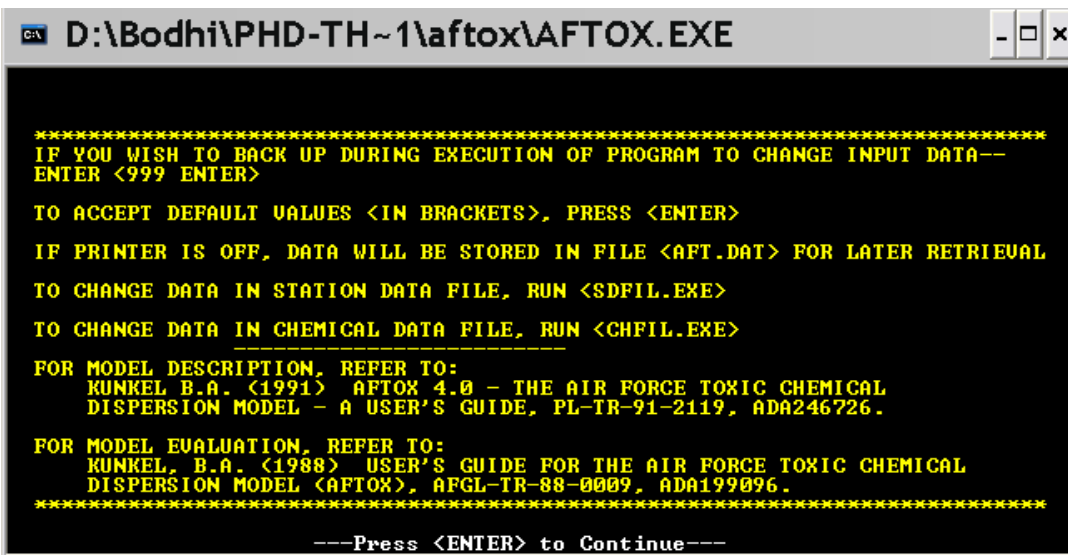

(b)

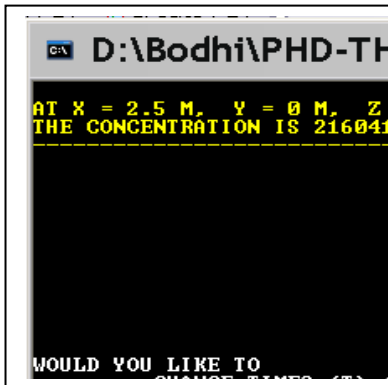

(c)

Figure C 1 Input and Output screens for AFTOX

Discussion: AFTOX also has an executable file which on execution gives the following screens as shown above.

The output can be obtained in the form of concentrations (PPM) at various distances from the stack, as desired by the user. A sample is also shown in Figure C 1(c).

APPENDIX D

ALOHA 5.4 Sample Input and Output

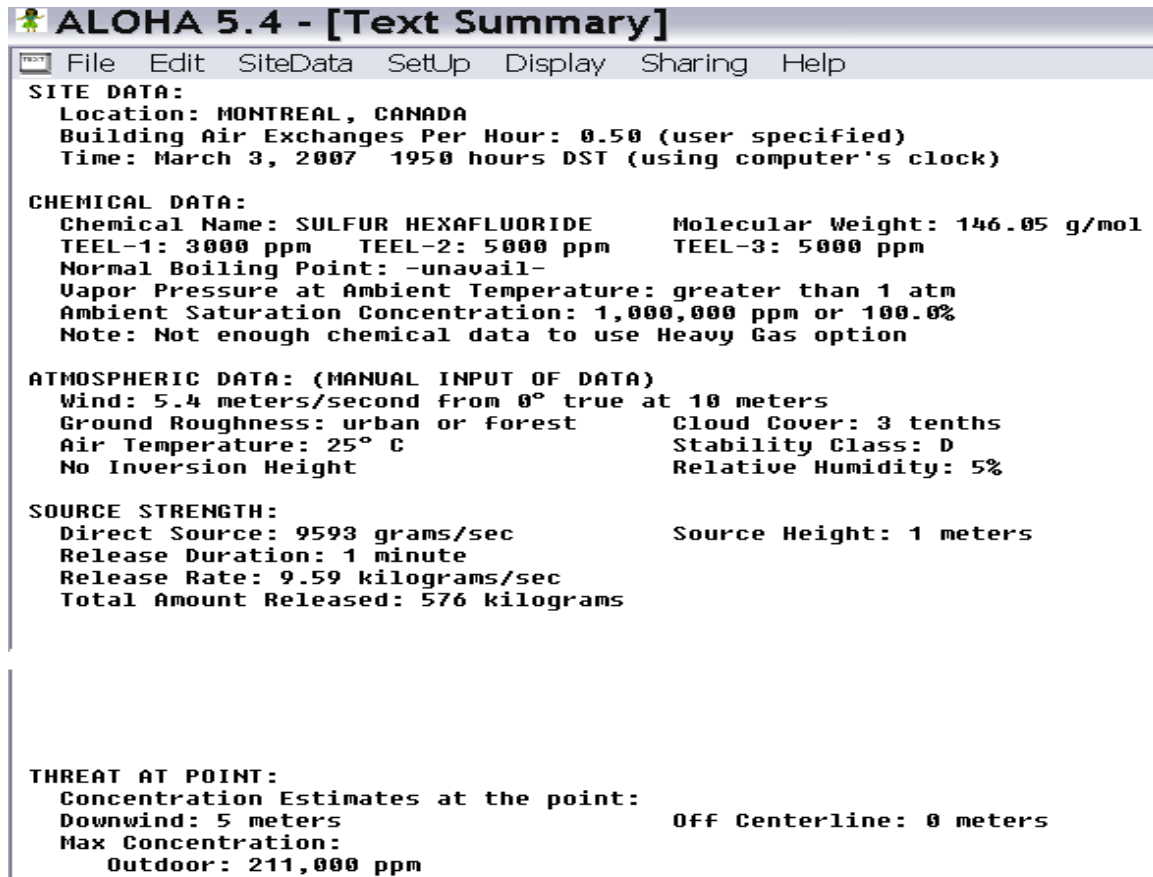

```
ALOHA 5.4 - [Text Summary]
File Edit SiteData SetUp Display Sharing Help
SITE DATA:
Location: MONTREAL, CANADA
Building Air Exchanges Per Hour: 0.50 (user specified)
Time: March 3, 2007 1950 hours DST (using computer's clock)

CHEMICAL DATA:
Chemical Name: SULFUR HEXAFLUORIDE      Molecular Weight: 146.05 g/mol
TEEL-1: 3000 ppm    TEEL-2: 5000 ppm    TEEL-3: 5000 ppm
Normal Boiling Point: -unavail-
Vapor Pressure at Ambient Temperature: greater than 1 atm
Ambient Saturation Concentration: 1,000,000 ppm or 100.0%
Note: Not enough chemical data to use Heavy Gas option

ATMOSPHERIC DATA: (MANUAL INPUT OF DATA)
Wind: 5.4 meters/second from 0° true at 10 meters
Ground Roughness: urban or forest      Cloud Cover: 3 tenths
Air Temperature: 25° C                  Stability Class: D
No Inversion Height                     Relative Humidity: 5%

SOURCE STRENGTH:
Direct Source: 9593 grams/sec           Source Height: 1 meters
Release Duration: 1 minute
Release Rate: 9.59 kilograms/sec
Total Amount Released: 576 kilograms

THREAT AT POINT:
Concentration Estimates at the point:
Downwind: 5 meters                      Off Centerline: 0 meters
Max Concentration:
Outdoor: 211,000 ppm
```

Figure D 1 Input-Output screen for ALOHA 5.4

Discussion: Figure D 1 shows an Input and output screen obtained from ALOHA 5.4 which is also recognized by the EPA. As observed, the output is produced in the form of concentrations which have to be converted into dilutions to make them comparable to results obtained from other models.