

Evaluation of a Horizontal Lifeline System, Anchorage Connectors and Braced Trusses as Host Structure for Residential Roofing Work

André Lan
Bertrand Galy

STUDIES AND
RESEARCH PROJECTS

R-988

OUR RESEARCH is working for you !

The Institut de recherche Robert-Sauvé en santé et en sécurité du travail (IRSST), established in Québec since 1980, is a scientific research organization well-known for the quality of its work and the expertise of its personnel.

Mission

To contribute, through research, to the prevention of industrial accidents and occupational diseases and to the rehabilitation of affected workers;

To disseminate knowledge and serve as a scientific reference centre and expert;

To provide the laboratory services and expertise required to support the public occupational health and safety network.

Funded by the Commission des normes, de l'équité, de la santé et de la sécurité du travail, the IRSST has a board of directors made up of an equal number of employer and worker representatives.

To find out more

Visit our Web site for complete up-to-date information about the IRSST. All our publications can be downloaded at no charge.

www.irsst.qc.ca

To obtain the latest information on the research carried out or funded by the IRSST, subscribe to our publications:

- *Prévention au travail*, the free magazine published jointly by the IRSST and the CNESST (preventionautravail.com)
- [InfoIRSST](#), the Institute's electronic newsletter

Legal Deposit

Bibliothèque et Archives nationales du Québec
2017

ISBN : 978-2-89631-965-7

ISSN : 0820-8395

Evaluation of a Horizontal Lifeline System, Anchorage Connectors and Braced Trusses as Host Structure for Residential Roofing Work

André Lan, Bertrand Galy

IRSST

STUDIES AND
RESEARCH PROJECTS

R-988



Disclaimer

The IRSST makes no guarantee as to the accuracy, reliability or completeness of the information in this document.

Under no circumstances may the IRSST be held liable for any physical or psychological injury or material damage resulting from the use of this information.

Document content is protected by Canadian intellectual property legislation.

A PDF version of this publication is available on the IRSST Web site.





PEER REVIEW

In compliance with IRSST policy, the research results published in this document have been peer-reviewed.

ACKNOWLEDGMENTS

This study was made possible by the cooperation and support of a large number of organizations and individuals. We especially wish to thank the following people and organizations:

- The technical team of the Structural Engineering Research Group at Polytechnique Montréal for its contribution to the experimental program;
- Bertrand Gauthier, Confédération des syndicats nationaux – Construction;
- Simon Lévesque, Fédération des travailleurs et travailleuses du Québec – Construction;
- Isabelle Dugré, Association paritaire pour la santé et la sécurité du travail du secteur de la construction;
- Martin Lemieux, Syndicat québécois de la construction;
- Pierre-Luc Labelle, Commission des normes, de l'équité, de la santé et de la sécurité du travail (CNESST);
- Stéphane Desjardins, Association des professionnels de la construction et de l'habitation du Québec (APCHQ);
- Yohann Aubé, Gestion d'entreprise en santé et en sécurité (GESTESS).

ABSTRACT

Construction workers who install roof trusses are at risk of falling because they have to work at height in difficult conditions. Poised precariously on the framework, they may lose their balance or fall when putting trusses into place. To protect its workers from falling while installing trusses, plywood or shingles, a residential contractor recently developed a horizontal lifeline system (HLLS) consisting of two aluminum posts and a steel cable using the roof they are erecting as the host structure. The HLLS, although operational, is heavy and not very user-friendly, which is keeping it from being used on construction sites. Yet preliminary testing on a roof on which work had been completed showed that the system has potential as a component of a fall-arrest system. So, at the request of the sector-based OHS association ASP-Construction, the Institut de recherche Robert-Sauvé en santé et en sécurité du travail (IRSST) conducted this study with the aim of evaluating the HLLS to make it more efficient, user-friendly and reliable by improving the installation method and making it lighter. A second aim of the study was to confirm the strength of braced roof trusses as a host structure for a worker's lanyard, the HLLS and anchoring connectors certified to standard CAN/CSA Z259.15 – *Anchorage Connectors*.

To do so, (1) a structural analysis of the HLLS was done in compliance with standard CAN/CSA S157 – *Strength Design in Aluminum*, (2) drop testing to confirm the HLLS's strength was done on a structure in a laboratory at Polytechnique Montréal and (3) drop testing to confirm the strength of the trusses as a host structure for the HLLS and CAN/CSA Z259.15-certified roofing anchorage connectors was done on braced roof trusses reconstructed at the Polytechnique Montréal lab. The drop testing met the requirements of standard CAN/CSA Z259 respecting fall protection.

Initially, when the host structure was being reconstructed in the lab, the trusses were to be braced following the recommendations of the Association québécoise des fabricants de structures de bois (AQSFB) or those of the Centre d'expertise sur la construction commerciale en bois (CECOBOIS), but the residential building contractor informed us that in practice, contractors almost never follow the recommendations of those two organizations when bracing trusses, but instead use a method acquired through experience that has proven itself over time. So there was no point testing the strength of a host structure braced according to the recommendations of the AQSFB or CECOBOIS, because they are not followed on construction sites. It was therefore decided to brace the reconstructed structure following the usual practice on jobsites, document the setup and test its strength as a host structure for the HLLS and CAN/CSA Z259.15-certified anchorage connectors.

The HLLS passed all the drop tests and therefore met the performance and strength requirements for such a system. The results of the dynamic drop tests showed that:

- The 127 mm x 127 mm x 6.4 mm aluminum HSS stanchions serving as posts for the HLLS passed all the dynamic drop tests as an anchorage for a lanyard;
- The HLLS consisting of 127 mm x 127 mm x 6.4 mm HSS posts and a DBI Sala Sayflineline passed all the dynamic drop tests as a fall arrester;

- The trusses braced according to current practices on construction sites passed all the dynamic drop tests as the host structure for a worker's lanyard with the 127 mm x 127 mm x 6.4 mm HSS as anchorage;
- The trusses braced according to current practices on construction sites needed reinforcement in order to pass the tests. The structure with the reinforced bracing passed all the dynamic drop tests as the HLLS host structure with 127 mm x 127 mm x 6.4 mm HSS posts as system uprights;
- The reinforced trusses braced according to current practices on construction sites passed all the dynamic drop tests as the host structure for DBI, Protecta and Ridge CSA Z259.15-certified anchorage connectors. The results obtained with these three types of connectors indicate that reinforced braced trusses form an appropriate structure to which to attach CAN/CSA Z259.15-certified anchorage connectors.

Furthermore, the contractor's HLLS was improved by reducing the number of parts to make it easier to secure it to the host structure. This also reduced the system's weight by at least 30%. The HLLS gives workers greater mobility and protects them the entire time they are working, while also enhancing productivity. It therefore provides good protection against falls from heights for residential roofers. The cable turnbuckle from the original version of the contractor's HLLS was removed in the study version to cut costs and facilitate testing, as it had no structural function. This improved version of the cable system, checked and validated by tests that meet the requirements of standard CSA Z259 respecting fall protection, will make it easier to use on construction sites.

CONTENTS

ACKNOWLEDGMENTS	I
ABSTRACT	III
CONTENTS	V
LIST OF TABLES	VIII
LIST OF FIGURES.....	IX
LIST OF ACRONYMS AND ABBREVIATIONS	XIII
1. INTRODUCTION.....	1
1.1 Occupational Health and Safety Background.....	1
1.1.1 Falls from Heights.....	1
1.1.2 Fall Protection with an HLLS	2
1.1.3 Topology of an HLLS Developed by a Housing Contractor – Installation on a Roof Framework	3
1.2 Research Objectives.....	4
2. METHOD	7
2.1 Preliminary Evaluation of HLLS	7
2.2 Horizontal Lifeline System Chosen	9
2.3 Anchorage Connectors Chosen.....	13
2.3.1 Protecta Ridge Roof Anchor: Model 2103678	13
2.3.2 DBI Roof Anchor: Model 2103676	13
2.3.3 Protecta Roof Anchor: Model AJ730A.....	14
2.4 Laboratory Reconstruction of a Wooden House Framework as a Host Structure for an HLLS	15
2.4.1 Description of Framework	15
2.4.2 Bracing.....	20
2.5 Dynamic Drop-Testing Program – Dynamic Performance and Strength Tests	26

2.5.1	Verification of Performance and Strength of 127 mm x 127 mm x 6.4 mm HSS as a Lanyard Anchorage Point	27
2.5.2	Verification of Performance and Strength of 127 mm x 127 mm x 6.4 mm HSS as an HLLS Anchorage Post	30
2.5.3	Verification of Performance and Strength of Braced Trusses as Host Structure of a Post for Anchoring a Lanyard	35
2.5.4	Verification of Performance and Strength of Braced Trusses as Host Structure of an HLLS	38
2.5.5	Verification of Performance and Strength of Braced Trusses as Host Structure for CAN/CSA Z259.15-Certified Anchorage Connectors	42
3.	RESULTS	47
3.1	Performance and Strength of 127 mm x 127 mm x 6.4 mm HSS as a Lanyard Anchorage Point.....	47
3.2	Performance and Strength of 127 mm x 127 mm x 6.4 mm HSS as an HLLS Anchorage Post.....	51
3.3	Performance and Strength of Braced Trusses as Host Structure of a Post for Anchoring a Lanyard	55
3.4	Performance and Strength of Braced Trusses as Host Structure of an HLLS	58
3.5	Performance and Strength of Braced Trusses as Host Structure for CAN/CSA Z259.15-Certified Anchorage Connectors	62
4.	DISCUSSION.....	75
4.1	HLLS Evaluation	75
4.2	HLLS Improvement.....	75
4.3	Trusses Braced According to Common Jobsite Practices as a Host Structure of a Post for Anchoring a Worker’s Lanyard.....	76
4.4	Trusses Braced According to Common Jobsite Practices as an HLLS Host Structure	76
4.5	Trusses Braced According to Common Jobsite Practices as a Host Structure for CAN/CSA Z259.15-Certified Anchorage Connectors	76
4.5.1	Dynamic Performance Testing	76
4.5.2	Dynamic Strength Testing (Failure)	77
4.6	Scope and Limitations of Study	78
5.	CONCLUSION AND RECOMMENDATION	79

BIBLIOGRAPHY.....	81
APPENDIX A – HLLS EVALUATION.....	83
APPENDIX B – 3D MODEL OF STRUCTURE.....	93

LIST OF TABLES

Table 1 – Summary of structural analysis of HLLS with fixed end of 54 in. (1.37 m) and Zorbit 11.36 kN (2,500 lb) energy absorber on HLLS	8
Table 2 – Nominal dimensions and properties of posts	9
Table 3 – Performance and strength tests of HLLS post as lanyard anchorage	29
Table 4 – Verification of 127 mm x 127 mm x 6.4 mm HSS as HLLS anchorage post	33
Table 5 – Verification of strength of braced trusses as host structure of a post for anchoring a lanyard.....	35
Table 6 – Verification of strength of braced trusses as host structure of an HLLS	39
Table 7 – Verification of strength of braced trusses as host structure for CAN/CSA Z259.15-certified anchorage connectors.....	44
Table 8 – Results of performance and strength testing of 127 mm x 127 mm x 6.4 mm HSS post as a lanyard anchorage	47
Table 9 – Results of performance and strength testing of 127 mm x 127 mm x 6.4 mm HSS as an HLLS anchorage post	52
Table 10 – Results of performance and strength testing of braced trusses as a host structure for a lanyard	57
Table 11 – Results of performance and strength testing of braced trusses as an HLLS host structure.....	60
Table 12 – Summary of results of Table 7 tests.....	65
Table 13 – Observations made after Table 7 tests	66

LIST OF FIGURES

Figure 1 – Worker poised precariously.....1

Figure 2 – Risk of being hit by a truss2

Figure 3 – Prototype of builder’s horizontal lifeline system3

Figure 4 – Ends of posts: (a) upper end of posts 1 and 2 (b) lower end of post 29

Figure 5 – Lower end of post 2 with 4 stabilizing cross braces.....10

Figure 6 – Schematic drawing of system’s components.....11

Figure 7 – System for attaching post 2 to central upright of roof truss: (a) system by itself;
 (b) system installed12

Figure 8 – Sayflite 3/8 in. wire rope horizontal lifeline.....12

Figure 9 – Ridge roof anchor13

Figure 10 – DBI roof anchor.....14

Figure 11 – Securing DBI anchors to roof.....14

Figure 12 – Protecta roof anchor, model AJ730A15

Figure 13 – Comparison of 3D model with photos.....16

Figure 14 – Irregular spacing of roof trusses because of structural columns17

Figure 15 – Dimensions of roof of structure.....17

Figure 16 – Dimensions of a roof truss.....18

Figure 17 – Securing of post to host structure19

Figure 18 – Structure extension built to anchor west cross brace of west post19

Figure 19 – 2 in. x 6 in. lumber used to anchor east cross brace of east post.....20

Figure 20 – Bracing of base of structure.....21

Figure 21 – Bracing recommended by CECOBOIS on vertical members of roof trusses21

Figure 22 – Bracing on roof truss rafters (AQFSB, 2009a, b).....22

Figure 23 – Bracing at base of roof trusses, in horizontal plane (AQFSB, 2009a, b)22

Figure 24 – Bracing on vertical and diagonal members of roof trusses (AQFSB, 2009a, b).....23

Figure 25 – Changes in bracing24

Figure 26 – Details of reinforced bracing (red)25

Figure 27 – Members placed end to end to enhance horizontal force transmission26

Figure 28 – Drawing of setup for validation testing of post as lanyard anchorage point28

Figure 29 – Experimental setup to anchor posts for testing described in Table 3:
 (a) complete setup; (b) support at mid-span; (c) support at mid-span (view
 from below); (d) support at far end of fixed-end installation30

Figure 30 – Drawing of setup for validation testing of post as HLLS anchorage point	32
Figure 31 – Anchorage of posts to anchorage column	34
Figure 32 – Verification of strength of a braced truss as host structure of a post for anchoring a lanyard.....	36
Figure 33 – Illustration of setup for validation testing of host structure for a post as a single anchorage	37
Figure 34 – Illustration of setup for validation testing of HLLS host structure	40
Figure 35 – Illustration of configurations for validation testing of HLLS host structure.....	41
Figure 36 – Dynamic drop testing	43
Figure 37 – Nailing of anchorage connectors for test 3 of Table 7: (a) Protecta, (b) DBI, (c) Ridge.....	45
Figure 38 – Table 3, test 3: (a) before and (b) after triggering drop of wooden torso.....	48
Figure 39 – Safety harness fall arrest indicators: (a) activated; (b) not activated.....	49
Figure 40 – Free-fall distance and maximum arrest force for test 3 (typical curves).....	49
Figure 41 – Test 1: force in lanyard and deflection of post	50
Figure 42 – Test 4: force in lanyard and deformation of post	51
Figure 43 – Table 4, test 5: (a) before and (b) after triggering drop of wooden torso.....	53
Figure 44 – Deployment of Zorbit system with 13 rips in test 4 of Table 4.....	53
Figure 45 – Deployment of Zorbit system with 14 rips in test 5 of Table 4.....	54
Figure 46 – Deployment of Zorbit system with 13 rips in test 6 of Table 4.....	54
Figure 47 – Test 1: tension in cable and deformation of post.....	55
Figure 48 – Test 5: tension in cable and deformation of post.....	55
Figure 49 – Table 5, test 4: (a) before test, (b) after test.....	56
Figure 50 – Slight damage to host structure following test 4 of Table 5.....	58
Figure 51 – Test 5: (a) before and (b) after triggering drop of steel mass	59
Figure 52 – Rupture of diagonal and top chord on east side, during test 1 of Table 6.....	61
Figure 53 – Lumber (in red) added to framework after failure during test 1 of Table 6	61
Figure 54 – Rupture at roof ridge on east side, during test 6 of Table 6	62
Figure 55 – Configuration of anchorage connectors for test 1: (a) Protecta, (b) DBI, (c) Ridge.....	63
Figure 56 – Test 2: Ridge anchorage connectors.....	63
Figure 57 – Nailing of anchorage connectors for test 3: (a) Protecta, (b) DBI, (c) Ridge.....	64
Figure 58 – Lifting of anchorage connectors in test 3: (a) DBI, (b) Protecta, (c) Ridge	67

Figure 59 – Lifting of anchorage connectors in test 4: (a) DBI, (b) Protecta, (c) Ridge68

Figure 60 – Test 7 with Protecta anchorage connector: (a) failure of lanyard snap hook;
(b) lifting and partial pulling out of nails of upper leg of anchor69

Figure 61 – Failure of roof eave in test 8 with Protecta anchor.....69

Figure 62 – Test 8 with Protecta anchorage connector: lifting and partial pulling out of
nails of upper leg of anchor70

Figure 63 – Test 8 with Protecta anchorage connector: partial damage of attachment to
snap hook of nylon strap lanyard70

Figure 64 – Test 9 with Protecta anchorage connector: lifting and partial pulling out of
nails of upper leg of anchorage connector70

Figure 65 – Test 9 with Protecta anchorage connector: damage to roof eave71

Figure 66 – Test 7 with DBI anchorage connector: state of anchor after test71

Figure 67 – Test 7 with DBI anchorage connector: steel mass fell to the ground.....71

Figure 68 – 2 in. x 6 in. lumber added to double roof truss after an anchor was ripped out:
(a) east side of truss; (b) west side of truss72

Figure 69 – DBI anchorage connector: (a) lifting of anchor and pulling out of nails during
test 8 of Table 7; (b) lifting of anchor and pulling out of nails during test 9.....73

Figure 70 – Test 7 with Ridge anchorage connector: state of anchor after test.....73

Figure 71 – Test 8 with Ridge anchorage connector: state of anchor after test.....74

Figure 72 – Test 9 with Ridge anchorage connector: state of anchor after test.....74

LIST OF ACRONYMS AND ABBREVIATIONS

AMCQ	Association des maîtres couvreurs du Québec
APCHQ	Association des professionnels de la construction et de l’habitation du Québec
AQFSB	Association québécoise des fabricants de structures de bois
ASCE	American Society of Civil Engineers
ASP Construction	Association paritaire pour la santé et la sécurité du travail du secteur de la construction
CAN/CSA	Canadian/Canadian Standards Association
CECOBOIS	Centre d’expertise sur la construction commerciale en bois
CMHC	Canada Mortgage and Housing Corporation
CNESST	Commission des normes, de l’équité, de la santé et de la sécurité du travail
CSA	Canadian Standards Association
CSA Group	Formerly known as the Canadian Standards Association
CSCE	Canadian Society for Civil Engineering
ÉTS	École de technologie supérieure
HLLS	Horizontal lifeline system
HSS	Hollow structural section
IRSST	Institut de recherche Robert-Sauvé en santé et en sécurité du travail
MPRP	Mechanical and Physical Risk Prevention
NBCC	National Building Code of Canada.
OSB	Oriented strand board
OSHA	Occupational Safety and Health Administration
ROHS	Regulation respecting Occupational Health and Safety
SCCI	Safety Code for the Construction Industry [Quebec]
SIJM	Service d’ingénierie Jean Massé
SPF	Spruce pine fir
UV	Ultraviolet

1. INTRODUCTION

1.1 Occupational Health and Safety Background

1.1.1 Falls from Heights

Falls from heights alone account for approximately 12% of all the workplace accidents that occur in the main sectors of the economy (Duguay and Massicotte, 2007). They are the primary cause of construction worker deaths. More specifically, roofers are exposed to approximately six times the serious accident risk of other workers. Seventy-five percent of roofers who fall die as a result (Lan and Daigle, 2011). In the construction industry, falls that cause injuries lead to lost time of 140 days on average and direct costs of more than \$6,500 (Duguay and Massicotte, 2007). International regulations are very clear: in the U.S.A., workers exposed to a risk of falling 1.8 m or more must be protected (OSHA, 1998). The equivalent limit in Quebec, under the Safety Code for the Construction Industry (SCCI) (S-2.1, r. 4, 2013) and the Regulation respecting Occupational Health and Safety (ROHS, 2013), is 3 m.

Construction workers who install roof trusses are at risk of falling because they have to work at height in difficult conditions. Poised precariously on the framework [Figure 1], they may lose their balance and fall or get hit by a truss when handling and installing one [Figure 2]. Falls can also occur if a roof truss tips over, due to a lack of temporary bracing installed in accordance with the recommendations of the Association québécoise des fabricants de structures de bois (AQFSB, 2009a, 2009b) or the Centre d'expertise sur la construction commerciale en bois (CECOBOIS, 2011).



Figure 1 – Worker poised precariously



Figure 2 – Risk of being hit by a truss

1.1.2 Fall Protection with an HLLS

A horizontal lifeline system (HLLS) consists of two anchoring endpoints, usually two steel or aluminum posts approximately 4 to 6 feet high attached to a host or support structure, and a horizontal lifeline (with or without an energy absorber) stretched between them. HLLSs are an inexpensive, effective way to protect workers against falls from heights. They have been used on many big construction sites in Quebec, including the General Motors paint factory in Boisbriand, which had a total roof surface area of over 40,000 m² (Alaurent et al., 1992) and the Montreal Canadiens training complex in Brossard. At the General Motors site, HLLSs prevented five falls from heights (Dupont, 2010), while at the Canadiens training complex, they saved the lives of eight workers when part of the structure collapsed (Dupont, 2010).

HLLS technology is well understood and mastered. Maximum anchoring loads are estimated using IRSST nomograms (Arteau and Lan, 1991) or by doing calculations with an Excel spreadsheet (based on the method proposed in Arteau and Lan's technical guide, for instance). The posts, subject to bending, torsion and shearing forces, are designed using classical strength-of-materials methods and steel or aluminum design codes. The horizontal lifeline (HLL) is usually a 12.7 mm (1/2 in.) steel cable. A smaller diameter cable can be used if it has been designed by an engineer in accordance with one of the following standards: ASTM 1023/A 1023M, Table 14; CSA G4-00;¹ EN 12385-4.9 or ISO 2408. For some applications where electricity is a factor, a synthetic fibre cable is a better choice.

1. Standard CSA G4 is cited in Z259.16, but it should be kept in mind that CSA G4 does not apply to aircraft cables (clause 1.3), although they are commonly used in fall protection.

1.1.3 Topology of an HLLS Developed by a Housing Contractor – Installation on a Roof Framework

To protect its roofing workers from falling while installing trusses, plywood or shingles, a residential contractor developed an HLLS installed at approximately 4 to 5 feet above the ridge to protect workers on all sides of the roof [Figure 3]. It consisted of:

- Two posts (A) equipped with tightening devices for securing them to the uprights of two end trusses or to the 3rd/4th trusses from each end; each post is made of three 2 in. x 6 in. x 16 ft. aluminum hollow structural sections (HSS) welded together; a turnbuckle (not shown in Figure 3) is attached to one of the HSSs to make it easy to tighten the cable;
- Two main steel horizontal lifelines (B);
- A lifeline (C) to host the rope grab of the worker’s lanyard;
- The energy absorber of the horizontal lifeline (F);
- Four stabilizing rods at the lower ends of the posts, fastened to the framework (not shown in Figure 3).

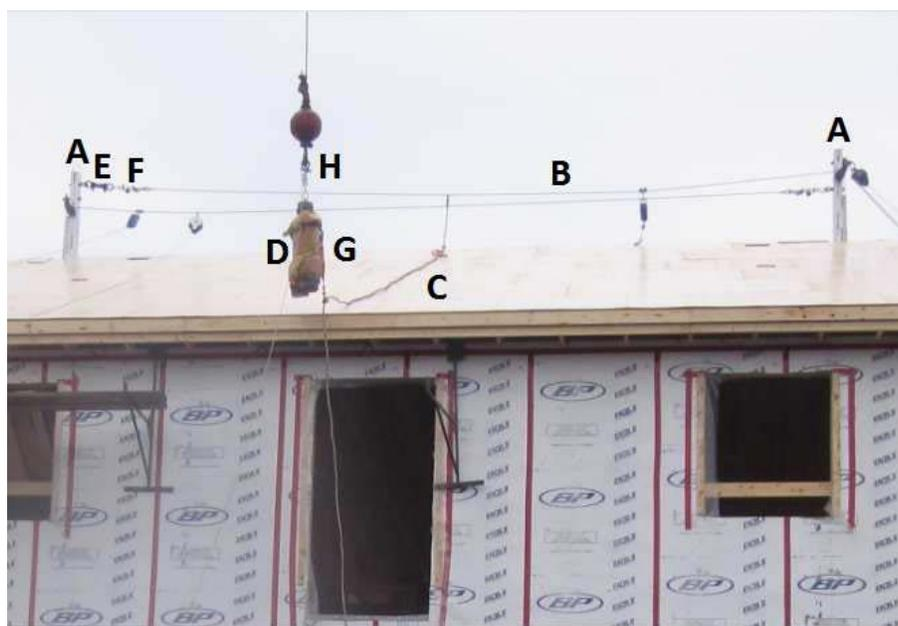

Figure 3 – Prototype of builder’s horizontal lifeline system

Once the roof is finished, the workers install CAN/CSA Z259.15-certified (CAN/CSA Z259.15, 2012) anchorage connectors on it to which they attach themselves before removing the HLLS and closing up the openings where the HLLS posts were.

The braced trusses are therefore used as the host structure for the HLLS—a function for which they were not designed. The only thing that remains to be determined is their strength as the host structure for the HLLS. A review of the literature found no study of trusses as a host structure. Generally, trusses are braced in accordance with AQFSB or CECOBOIS instructions. However, according to the residential contractor, those bracing instructions are rarely, if ever, followed. Given this fact, there was no point testing a host structure that is never erected on construction

sites. It was therefore decided to brace the trusses the way it is commonly done on jobsites, as described below. The originality of this study is thus the validation of trusses that have been braced according to current worksite practices as an HLLS host structure.

While functional and promising, the HLLS proposed by the residential roofer is heavy (> 90 kg [200 lb]) and not very user-friendly, which discourages its use on construction sites. It successfully completed some preliminary testing on a finished roof [Figure 3], a rigid, resistant structure,² but it had not been tested with braced trusses as a host structure when plywood or shingles were being installed.

1.2 Research Objectives

We received requests from ASP Construction and various roofing-related organizations: the Association des maîtres couvreurs du Québec (AMCQ), the Association des professionnels de la construction et de l'habitation du Québec (APCHQ) and the Commission des normes, de l'équité, de la santé et de la sécurité du travail (CNESST)³ asked us to (1) evaluate the HLLS designed by the contractor to see if we could improve it and (2) determine the strength of the trusses assembled and braced in accordance with usual construction practices as an HLLS host structure, as well as of the six CAN/CSA Z259.15-certified anchorage connectors, i.e., the kind most commonly used by roofing workers.

The research objectives can therefore be stated as follows:

- 1) Verify the strength of trusses braced according to common construction practices as a host structure for a worker's lanyard, by conducting drop testing that meets the requirements of standards CAN/CSA Z259 on fall protection, a function for which the trusses were not designed;
- 2) Verify the strength of trusses braced according to common construction practices as a host structure for an HLLS, by conducting drop testing that meets the requirements of standards CAN/CSA Z259 on fall protection, a function for which the trusses were not designed;
- 3) Verify the strength of trusses braced according to common construction practices as a host structure for six CAN/CSA Z259.15-certified anchorage connectors—those most commonly used by roofing workers—by conducting drop testing that meets the requirements of standards CAN/CSA Z259 on fall protection, a function for which the trusses were not designed.

To meet the first objective, two preliminary steps were necessary: (i) evaluate the HLLS proposed by the roofer according to reliability, efficiency and user-friendliness criteria with a view to improving it and (ii) make any changes deemed necessary to the HLLS and go through the evaluation procedure again.

The reliability, efficiency and user-friendliness criteria used for the evaluation are defined as follows:

2. SIJM, 2010, *Système de protection contre les chutes dans le domaine de la construction résidentielle*, Rapport d'analyse et d'essai, Service d'ingénierie Jean Massé, Beauport, Quebec.

3. Known until January 2016 as the Commission de la santé et de la sécurité du travail (CSST).

- Reliability: No deterioration caused by UV radiation or weather; easy to inspect visually, and the worker is familiar with all components.
- Efficiency: By design, governed by industry standards for the strength of materials, aluminum (CAN/CSA-S157, 2000) and steel (CAN/CSA-S16-09, 2014) design codes, and the requirements of standards CAN/CSA Z259 on fall protection.
- User-friendliness: Lightness of HLLS that makes it easier to handle and install, continuity of point of attachment to lanyards and little intervention required to activate worker protection while avoiding interference in work-related activities; by attaching themselves just once, workers can perform an uninterrupted sequence of actions throughout the duration of their tasks.

2. METHOD

2.1 Preliminary Evaluation of HLLS

The preliminary structural analysis of the HLLS is described in detail in Appendix A. The analysis was conducted according to classical strength-of-materials methods, design code CAN/CSA-S157 – *Strength Design in Aluminum* (CAN/CSA-S157, 2000), standard CAN/CSA-S16-1 – *Limit States Design of Steel Structures* (CAN/CSA S16-09, 2014) and the National Building Code of Canada (NBCC, 2010). To verify the strength of the HLLS, all possible failure modes of the HLLS had to be tested and each of its components had to be strong enough to withstand the loads applied to it. The posts of the HLLS had to be verified primarily with respect to bending and shear. To assess the performance of the HLLS, it was essential to ensure that its deformation was not excessive, so that the worker would not hit the floor, or any material or equipment on the floor, during an accidental fall arrest, and to check that the clearance available was adequate.

Table 1 sums up the structural assessment of the HLLS (see also Appendix A) with a 1.37 m (54 in.) fixed end and a Zorbit 11.36 kN (2,500 lb) energy absorber. The structural analysis showed that:

- The prototype of the HLLS, made of an assembly of three 2 in. x 6 in. aluminum HSSs (equivalent to 6 in. x 6 in.) welded together, is clearly oversized;
- 89 mm x 89 mm x 9.5 mm (3½ in. x 3½ in. x 3/8 in.) steel HSSs are adequate as HLLS posts;
- 102 mm x 102 mm x 9.5 mm (4 in. x 4 in. x 3/8 in.) aluminum HSSs are adequate as HLLS posts;
- 127 mm x 127 mm x 6.4 mm (5 in. x 5 in. x ¼ in.) aluminum HSSs are adequate as HLLS posts.

Structural steel HSSs of 89 mm x 89 mm x 9.5 mm (3½ in. x 3½ in. x 3/8 in.), with a length of 4.87 m (16 ft.), while adequate, are not recommended because of their weight (107 kg) and because they are not consistent with one of the research objectives, which was the improvement of user-friendliness. Aluminum HSSs of 102 mm x 102 mm x 9.5 mm (4 in. x 4 in. x 3/8 in.), with a length of 4.87 m (16 ft.), are the easiest sections to handle. They are therefore a good choice for HLLS posts, but since they are expensive and are available by special order only, they were not selected. Aluminum HSSs of 127 mm x 127 mm x 6.4 mm (5 in. x 5 in. x ¼ in.), with a length of 4.87 m (16 ft.), while slightly oversized, are lighter (39 kg) than 102 mm x 102 mm x 9.5 mm (43 kg) aluminum HSSs and are available commercially at an affordable price. This HSS was therefore chosen for the HLLS posts.

Table 1 – Summary of structural analysis of HLLS with fixed end of 54 in. (1.37 m) and Zorbit 11.36 kN (2,500 lb) energy absorber on HLLS

Horizontal lifeline system (HLLS)	Verification of bending	Verification of shear force	Analysis*	Length	Weight	Conclusion – Choice of post
Steel posts HSS: 89 mm x 89 mm x 9.5 mm (3½ in. x 3½ in. x 3/8 in) Fixed end: 54 in. (1.37 m) Energy absorber: 11.36 kN (2,500 lb) on HLLS	$\frac{C_f}{C_r} + \frac{U_{1x}M_{fx}}{M_{rx}} + \frac{U_{1y}M_{fy}}{M_{ry}} \leq 1$ $\frac{3}{725.5} + \frac{1 \times 23.48}{25.4} + \frac{1 \times 0}{25.4} \leq 1$ $0.00414 + 0.92 + 0 = 0.93 \leq 1 \text{ OK}$	$V_f \leq V_r$ $17 \text{ kN} \leq 290 \text{ kN} \text{ OK}$	HLLS okay, as bending governs	4.87 m (16 ft.)	107 kg (235 lb)	Too heavy: reject
Aluminum posts HSS: 102 mm x 102 mm x 9.5 mm (4 in. x 4 in. x 3/8 in) Fixed end: 54 in. (1.37 m) Energy absorber: 11.36 kN (2,500 lb) on HLLS	$\frac{C_f}{C_r} + \frac{U_{1x}M_{fx}}{M_{rx}} + \frac{U_{1y}M_{fy}}{M_{ry}} \leq 1$ $\frac{3}{619.9} + \frac{1 \times 23.48}{23.79} + \frac{1 \times 0}{23.79} \leq 1$ $0.00484 + 0.98 + 0 = 0.99 \leq 1 \text{ OK}$	$V_f \leq V_r$ $17 \text{ kN} \leq 214 \text{ kN} \text{ OK}$	HLLS okay, as bending governs	4.87 m (16 ft.)	43 kg (95 lb) OK	OK
Aluminum posts** HSS: 127 mm x 127 mm x 6.4 mm (5 in. x 5 in. x ¼ in) Fixed end: 54 in. (1.37 m) Energy absorber: 11.36 kN (2,500 lb) on HLLS	$\frac{C_f}{C_r} + \frac{U_{1x}M_{fx}}{M_{rx}} + \frac{U_{1y}M_{fy}}{M_{ry}} \leq 1$ $\frac{3}{535.5} + \frac{1 \times 23.48}{25.78} + \frac{1 \times 0}{25.78} \leq 1$ $0.0056 + 0.91 + 0 = 0.92 \leq 1 \text{ OK}$	$V_f \leq V_r$ $17 \text{ kN} \leq 192 \text{ kN} \text{ OK}$	HLLS slightly oversized, as bending governs	4.87 m (16 ft.)	39 kg (87 lb) OK	OK This post was chosen

Note: Density of aluminum 6061 T6 = 2,700 kg/m³; Density of structural steel = 7,850 kg/m³

*Minimum clearance still needs to be determined with the manufacturer's technical data for the energy absorber (see section A.2.4 in the appendix)

**Used for HLLS posts in this study

2.2 Horizontal Lifeline System Chosen

Following the structural analysis, the HLLS that was chosen and put through the dynamic drop testing had posts that consisted of 127 mm x 127 mm x 6.4 mm extruded aluminum HSSs, compliant with standard ASTM A221 ($F_y = 240$ MPa), and alloy 6061-T6511. Two post configurations described in Table 2 were tested with different lengths and attachment systems. In Table 2, the bending resistances of the posts, M_y and M_p , were determined using the nominal elastic limit of alloy 6061-T6511, $F_y = 240$ MPa (35 ksi). Moment M_y is the one that produces a stress equal to F_y at the extreme fibre of the post ($M_y = S \cdot F_y$), while moment M_p is the one that produces complete flexural plastification of the post ($M_p = Z \cdot F_y$).

Table 2 – Nominal dimensions and properties of posts

Post	HSS (mm x mm x mm)	Total length m (ft.)	Fixed end m (in.)	Length of fixed-end installation m (in.)	Moment of inertia mm^4	Elastic moment of resistance $M_y = S F_y$ $\text{kN}\cdot\text{m}$	Plastic moment of resistance $M_p = Z F_y$ $\text{kN}\cdot\text{m}$
1	127 x 127 x 6.4	3.048 (10)	1.524 (60)	1.524 (60)	7.05×10^6	26.8	31.7
2	127 x 127 x 6.4	4.877 (16)	1.524 (60)	3.353 (132)	7.05×10^6	26.8	31.7

Figure 4 shows the ends of the two posts studied. At the upper end of posts 1 and 2 [Figure 4(a)], a 32-mm diameter hole was drilled 152 mm (6 in.) from the end for an eye bolt (G-277 1¼ in.–8 in.). In the chosen HLLS, the lower end of post 2 [Figure 4(b)] is machined to take 4 scaffolding rods 2,235 mm [88 in.] in length [Figure 5] that serve to stabilize the system during installation [Figure 6].

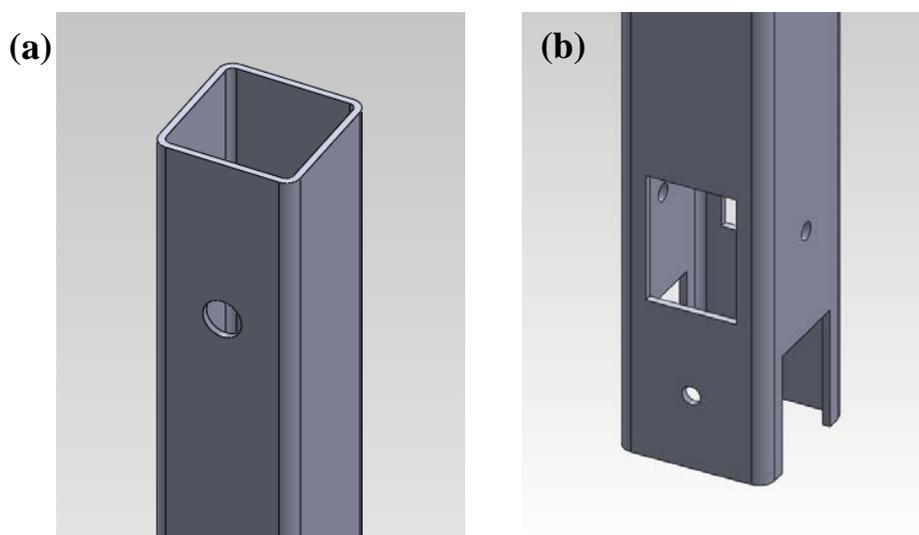

**Figure 4 – Ends of posts: (a) upper end of posts 1 and 2
(b) lower end of post 2**

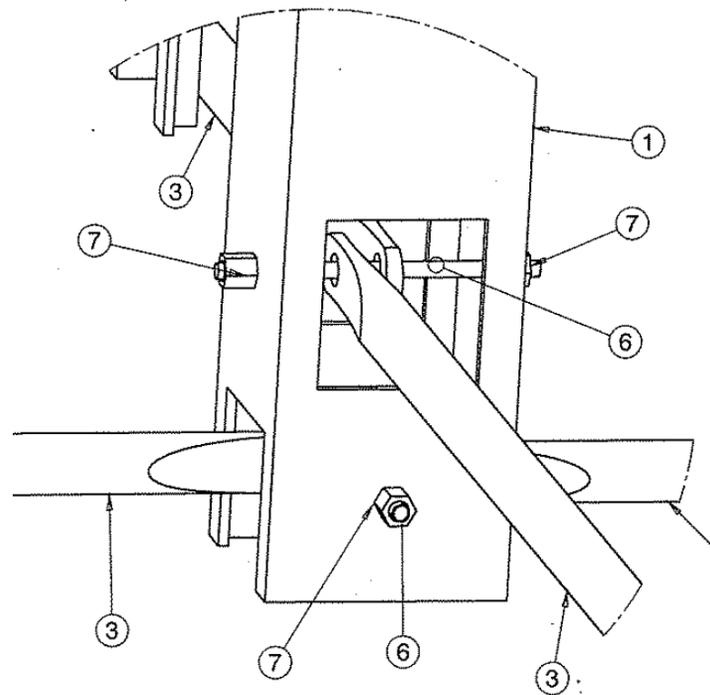

Figure 5 – Lower end of post 2 with 4 stabilizing cross braces

**(1) post 2; (3) 2,235 mm stabilizing cross brace (7 ft. scaffolding cross brace);
(6) threaded rod 12.7 mm [1/2 in.] in diameter and 203 mm [8 in.] long; (7) 12.7 mm
[1/2 in.] nut⁴**

4. Illustration excerpted from M. Riopel, 2012, *Conception d'un dispositif de prévention des chutes*, internship report, Polytechnique Montréal.

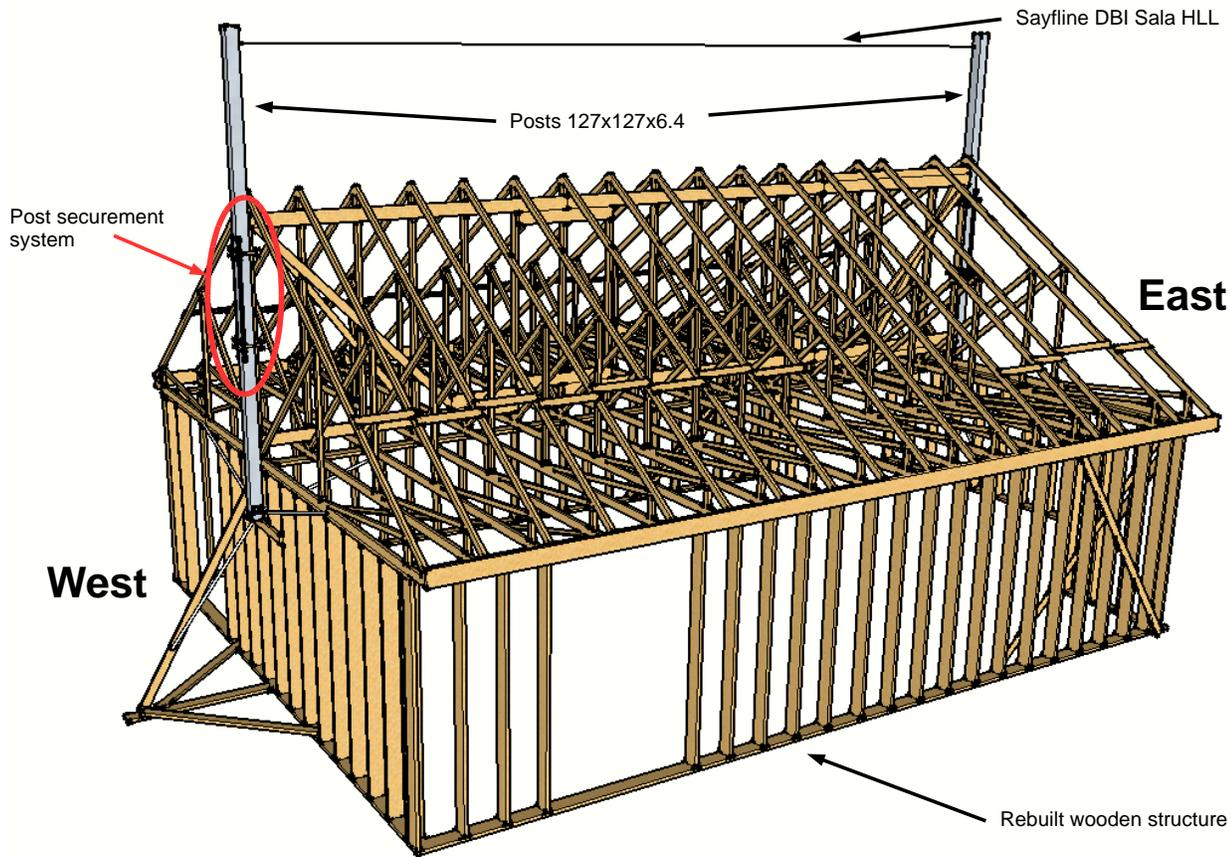

Figure 6 – Schematic drawing of system’s components

Figure 7 shows the attachment system chosen for the study to fasten post 2 to the central upright of the roof truss by means of four 12.7 mm [1/2 in.] threaded rods serving to secure the wooden upright to post 2 [Figure 7(a)]. This system was installed as high up as possible to optimize its efficiency [Figure 7(b)].

The horizontal lifeline used for the HLLS was the DBI Sala Sayfline Wire Rope model with a cable grip to adjust the span and a DBI Zorbit 11.36 kN (2,500 lb) energy absorber and a 9.5 mm (3/8 in.) diameter wire rope [Figure 8].

To sum up, the HLLS chosen for the testing consisted of:

- Two 16 ft. HSS (127 mm x 127 mm x 6.4 mm) aluminum posts. At the upper end of the posts, a 32-mm diameter hole was drilled 152 mm (6 in.) from the end for an eye bolt (G-277 1¼ in.–8 in.) [Figure 4];
- The posts are machined at the lower end to accommodate 88 in. long stabilizing rods [Figure 5];
- The new attachment system proposed by Riopel [Figure 7 (a) and (b)];
- No horizontal lifeline turnbuckle;
- A DBI Sala Sayfline 3/8 in. diameter wire rope [Figure 8].

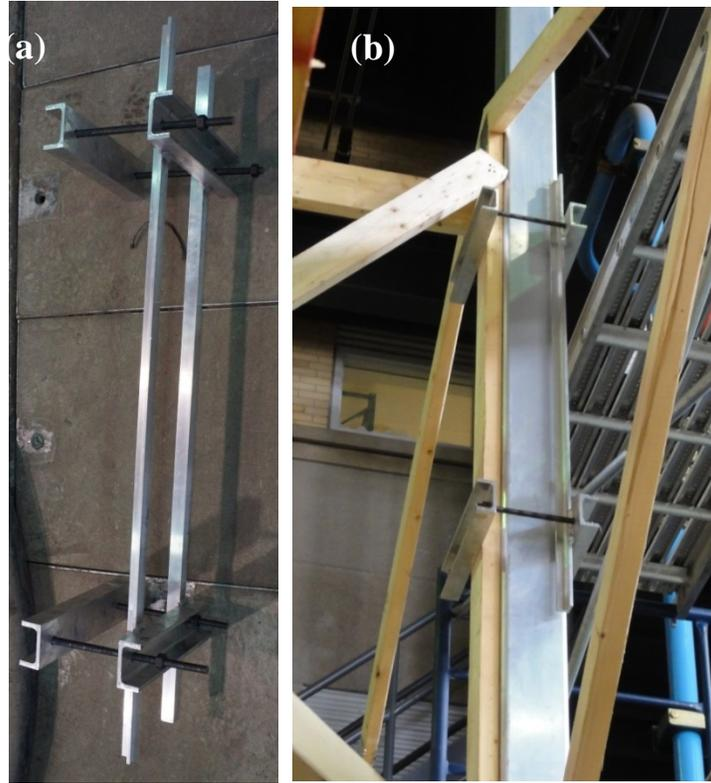

**Figure 7 – System for attaching post 2 to central upright of roof truss:
(a) system by itself; (b) system installed**

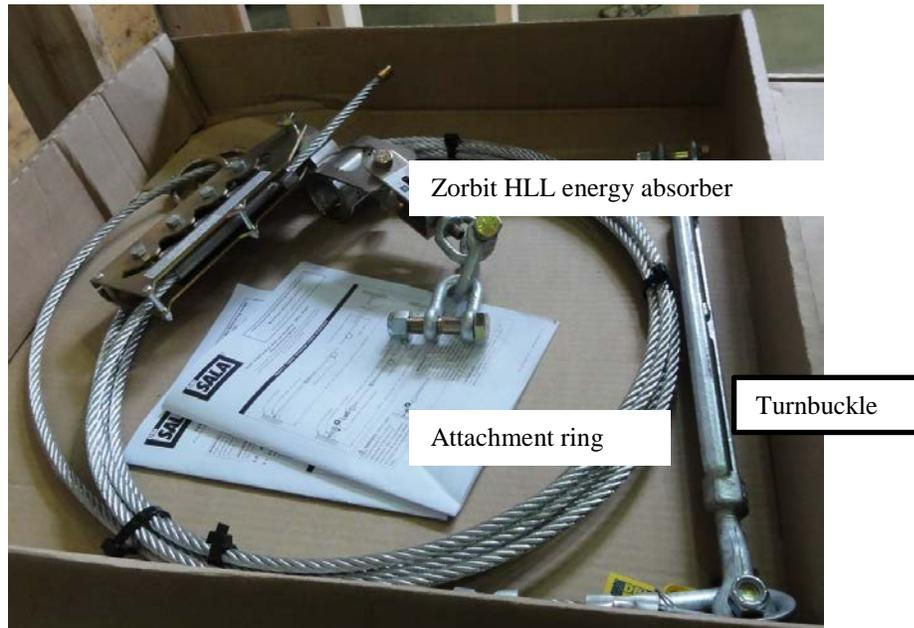

Figure 8 – Sayflite 3/8 in. wire rope horizontal lifeline

2.3 Anchorage Connectors Chosen

A survey was conducted of AMCQ and APCHQ members and of the CNESST to determine the models of CAN/CSA Z259.15-certified anchorage connectors most commonly used by roofers. A total of six anchorage connectors were identified. Of the six models, three were fairly hard to get at the time of the study. The choice therefore focused on the other three models, which are described in detail in the following sections.

2.3.1 *Protecta Ridge Roof Anchor: Model 2103678*

Ridge roof anchors are used as permanent anchorage connectors on wood frame structures. They consist of a zinc-plated, forged D ring on stainless steel construction, as shown in Figure 9.



Figure 9 – Ridge roof anchor

Ridge roof anchors must be installed in accordance with the manufacturer’s instructions. Depending on the surface that the anchor is to be mounted on—either the roof ridge or a flat surface—the anchor legs must be bent up and then the eight 20d coated sinker nails supplied with it are driven into a framing member.

2.3.2 *DBI Roof Anchor: Model 2103676*

DBI hinged roof anchors are used as temporary anchorage connectors on wooden frame structures. They consist of a forged D ring attached to a steel base, as shown in Figure 10.



Figure 10 – DBI roof anchor

DBI roof anchors must be installed in accordance with the manufacturer's instructions. The anchor base legs must be spread apart to match the surface they will be mounted on, either a roof ridge or a flat surface. The anchor is then installed by positioning the nail holes along the centre of the legs over a roof framing member. Finally, ten 16d nails must be driven in per leg, i.e., six into the rafters and four into the sheathing [Figure 11].

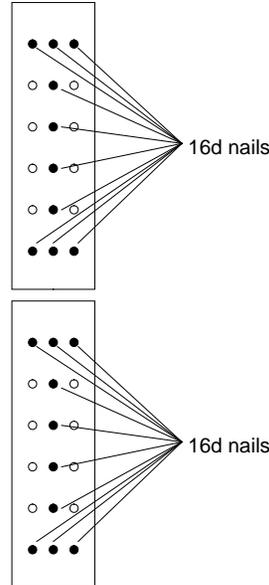

Figure 11 – Securing DBI anchors to roof

2.3.3 Protecta Roof Anchor: Model AJ730A

Protecta roof anchors [Figure 12] and DBI anchors are made by the same company. They are therefore identical and are installed as in the procedure described in section 2.3.2.



Figure 12 – Protecta roof anchor, model AJ730A

2.4 Laboratory Reconstruction of a Wooden House Framework as a Host Structure for an HLLS

As it was impossible to carry out dynamic drop testing on a real structure to validate the HLLS and the strength of the braced trusses as a host structure, a wooden framework for a house was reconstructed in a laboratory at Polytechnique Montréal in accordance with the rules for standard wood construction of the Canada Mortgage and Housing Corporation (CMHC, 2011). The structure was erected by the company Gaétan Sirois Construction under the supervision of Yves Sirois. The Grade 2 dried spruce-pine-fir (SPF) structure was assembled using 3.5 in. (16d) spiral nails driven in with a hammer and 3.25 in. (12d) spiral nails put in with a pneumatic nailer.

2.4.1 Description of Framework

2.4.1.1 3D Model Used to Illustrate Reconstructed Structure

The description of the structure reconstructed in the lab and its characteristics are based, first, on photographs taken during testing and, second, on a three-dimensional model of the structure created with Sketchup [Figure 13]. The 3D Sketchup model is interesting for a number of reasons. Its use of sharp colours highlights the structure's various components. It also makes it easier to remove certain elements that do not provide any relevant information for discussion (e.g., the structural columns of Polytechnique Montréal's structures laboratory). The 3D model also enables, in situ, perspectives that would otherwise be impossible. For all these reasons, we decided it was worthwhile using a 3D digital

scale model that accurately represented the structure assembled in the lab, to support the research objectives. Figure 13 compares the structure reconstructed in the lab with the 3D model version. It can be seen that a choice was made to represent the plywood as it was for the dynamic drop testing.

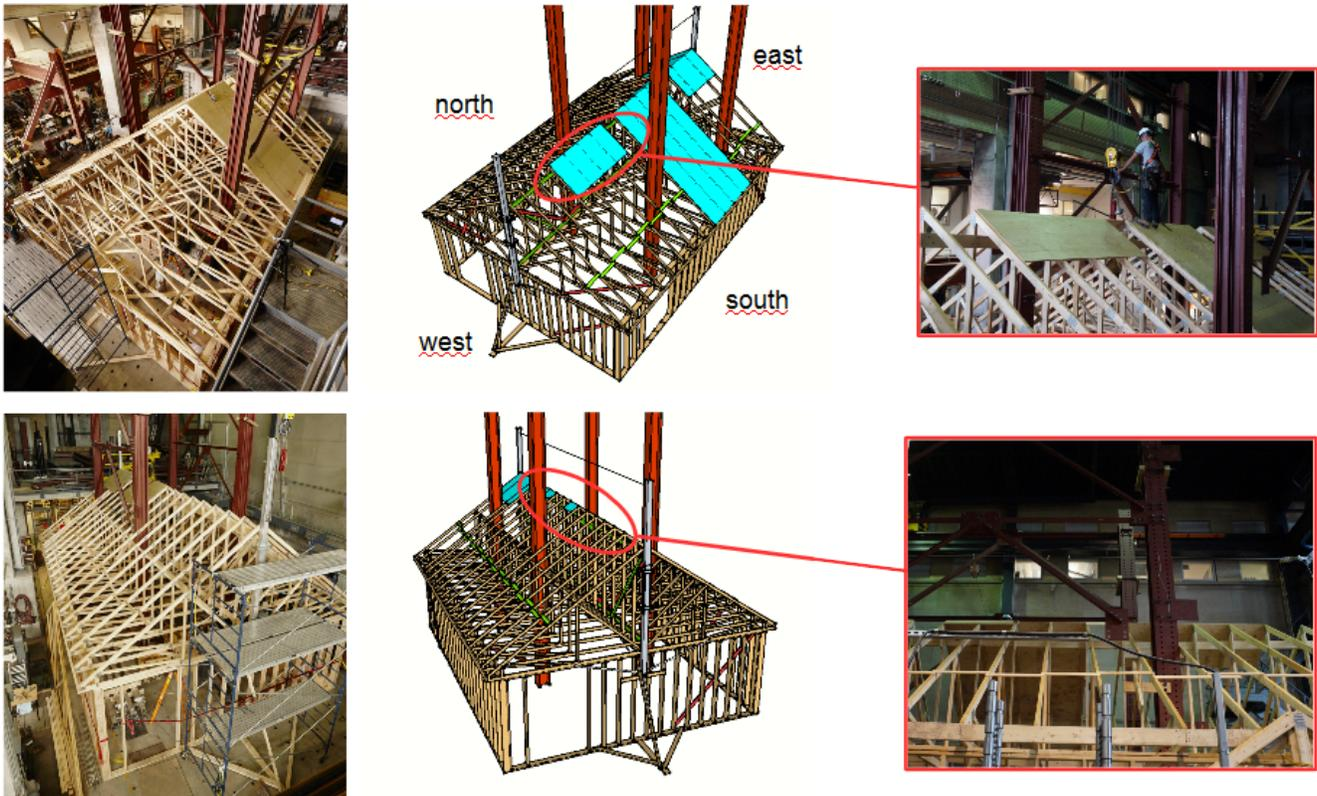

Figure 13 – Comparison of 3D model with photos

A model of the reconstructed framework in 3D with different views, activated by arrows, is presented in Appendix B. The model provides a quick way of looking at the most interesting views of the structure.

2.4.1.2 Dimensions of Host Structure

At ground level, the host structure had a width of 7.30 m [23 ft. 11½ in.] and a depth of 10.36 m [34 ft.]. Grade 2 dried 2 in. x 6 in. (38 mm x 140 mm) SPF lumber was used for all the framing of the outside walls, not counting the bracing. The studs were spaced regularly every 16 in. (406 mm) centre to centre. The 18 trusses had a span of 26 ft. and a pitch of 8/12. They were installed with a 1 ft. fixed end on each side of the wall. They were regularly spaced, with the exception of the structural columns [Figure 14, Figure 15], every 24 in. (610 mm) centre to centre. The framework was not secured to the ground, but it was fastened to the structural columns at a few places (circled in red on Figure 14). This anchoring to the structural columns was done to erect the framework. The fastening of the roof to the structural columns with two boards did not increase the resistance to lateral forces in any significant way. The bracing of the roof in its entirety is what added rigidity to the structure.

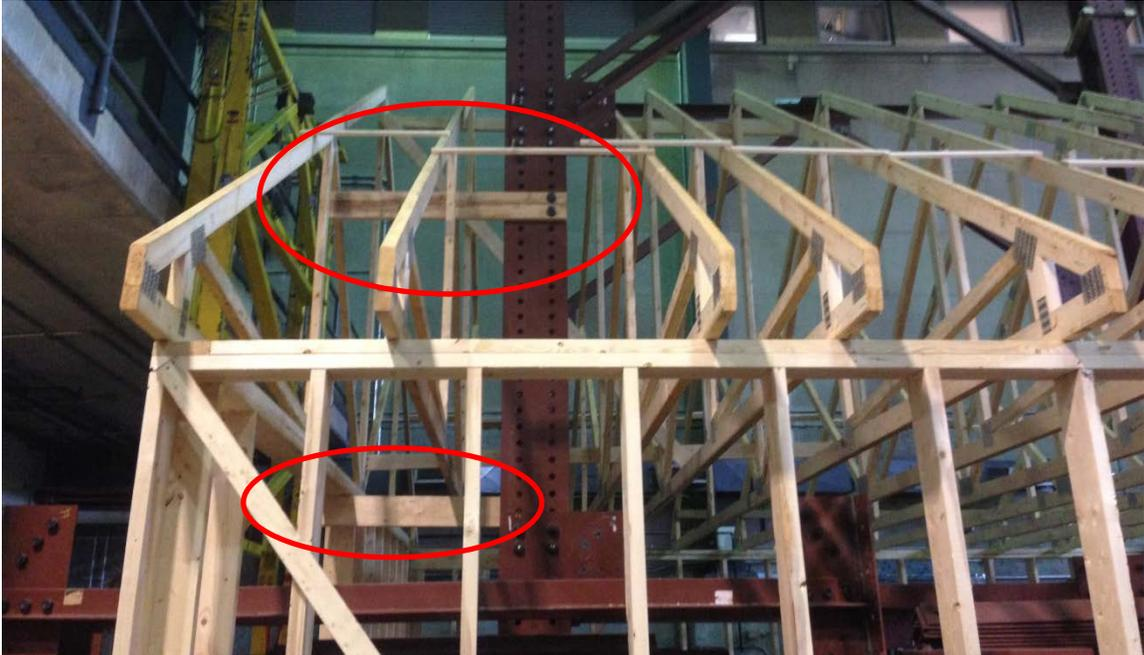

Figure 14 – Irregular spacing of roof trusses because of structural columns

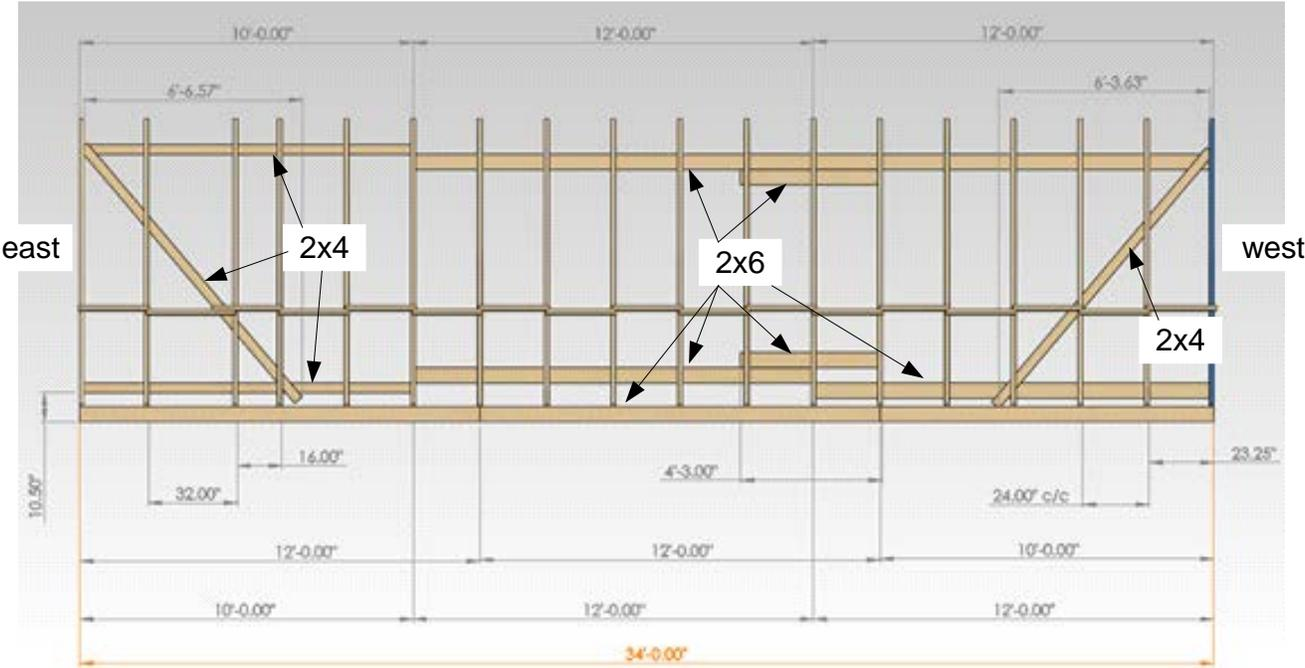

Figure 15 – Dimensions of roof of structure

2.4.1.3 Securing Posts to Host Structure

The posts of the HLLS were secured to each end of the house framework reconstructed in the lab. The details of how they were secured are shown in Figure 17. The detailed illustrations of the system for securing the post to the roof truss are bordered in red. The illustrations of the system for securing the base of the posts, consisting of four standard stabilizing rods for scaffolding, are bordered in green. Three of the rods were screwed into the host structure, while the fourth was screwed into an extension of the host structure built specifically for that purpose (Figure 18).



Figure 17 – Securing of post to host structure



Figure 18 – Structure extension built to anchor west cross brace of west post

A specific method was used to secure the east post cross brace in the east direction. The framework's footprint and the lack of clearance behind the east wall made it impossible to add an extension similar to

that for the west post. An anchorage located on a laboratory wall near the structure's east wall was used to place a 2 in. x 6 in. piece of lumber between it and the top of the east wall [Figure 19], to anchor the east cross brace of the east post.



Figure 19 – 2 in. x 6 in. lumber used to anchor east cross brace of east post

On construction sites, a system similar to the one for the west post is used, unless the post is installed at the third or fourth truss from the end, in which case, the cross brace is secured to a wood framing member.

2.4.2 Bracing

2.4.2.1 Bracing of Base of Structure

The bracing of the base of the structure built in the lab is shown in Figure 20 (in red). This type of bracing is normally installed only for building the framework, as after that the walls and load-bearing partitions themselves provide the bracing. In the case of the structure reconstructed in the lab, the bracing was installed by the construction team according to their judgment and experience. This bracing should not have had a significant impact on the results of the testing. The east wall had two openings that were required for storing large steel sections, which could not be stored elsewhere in the lab because they took up too much room. The high opening (a) was built around some steel parts, without touching them, whereas the studs of the low opening (b) rested on steel plates. The bracing consisted of 2 in. x 4 in. lumber.

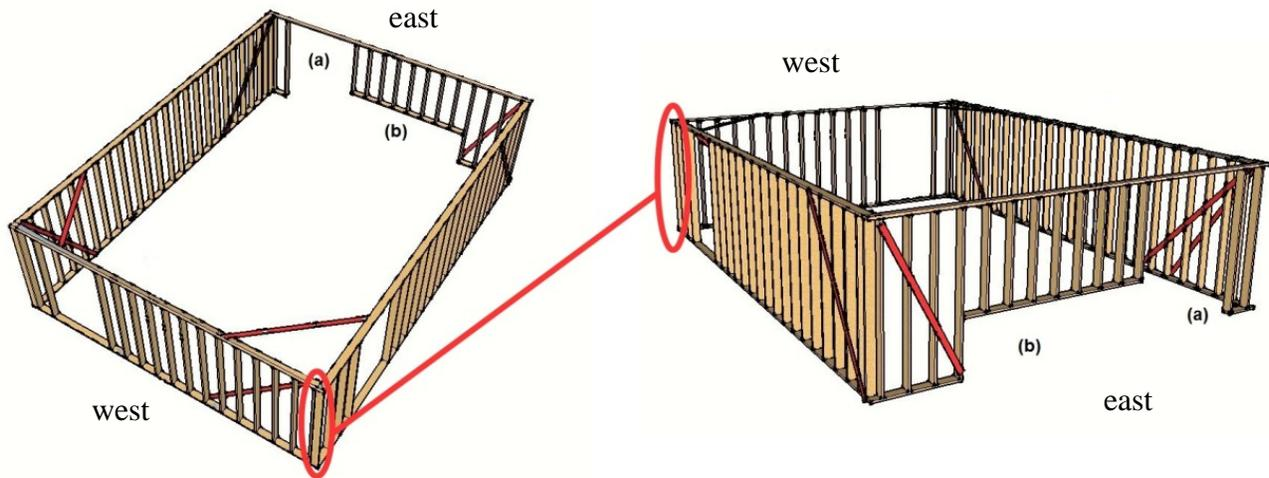

Figure 20 – Bracing of base of structure

2.4.2.2 Bracing Types Recommended by AQSFB and CECOBOIS

Figure 21 shows the bracing on the vertical members of roof trusses. A continuous horizontal link can be seen, along with diagonals for stabilization.

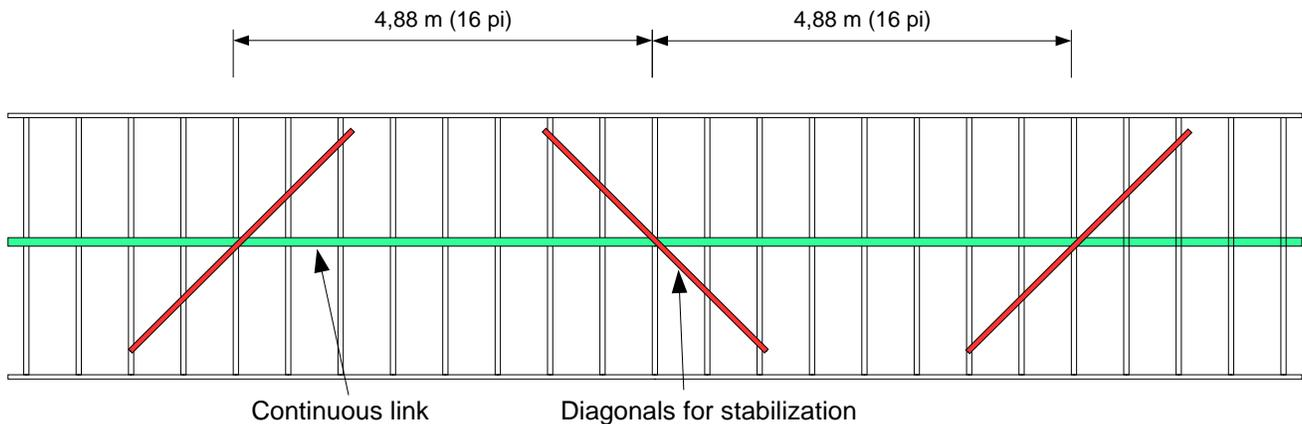

Figure 21 – Bracing recommended by CECOBOIS on vertical members of roof trusses

Figure 22 illustrates the temporary bracing recommended on the rafters of roof trusses. It consists of horizontal and diagonal members. This type of temporary bracing must be removed when plywood sheets are installed, which takes time and energy. This type of bracing is therefore not commonly used on residential construction sites.

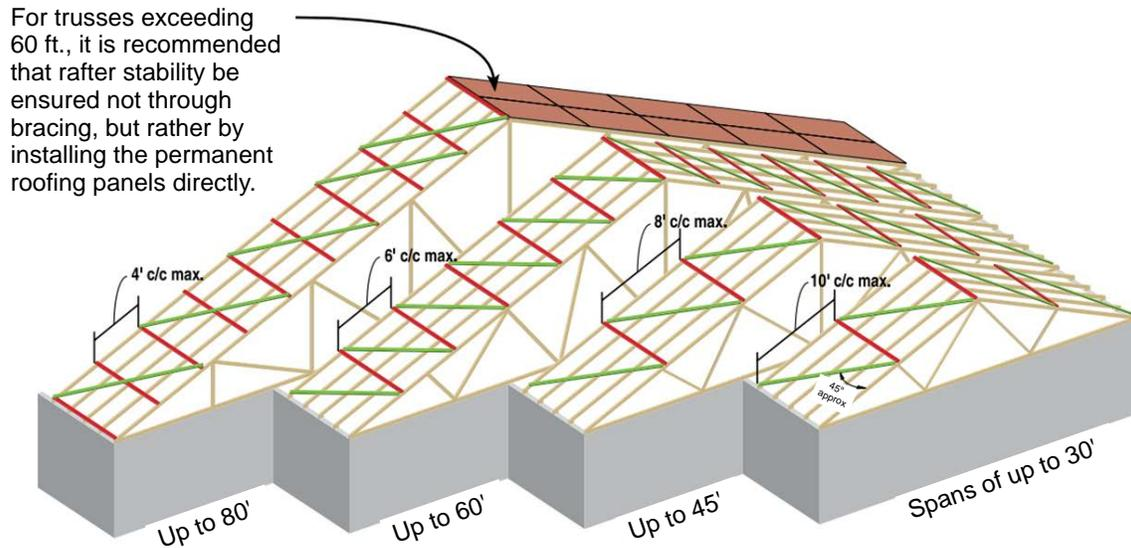

Figure 22 – Bracing on roof truss rafters (AQFSB, 2009a, b)

Figure 23 shows the bracing at the base of the roof trusses, in the horizontal plane. This type of temporary bracing, unlike bracing on the rafters, may be left in place permanently after the roof has been built. The disadvantage is that this type of bracing takes a fairly long time to install because such a large number of components must be nailed to the roof trusses.

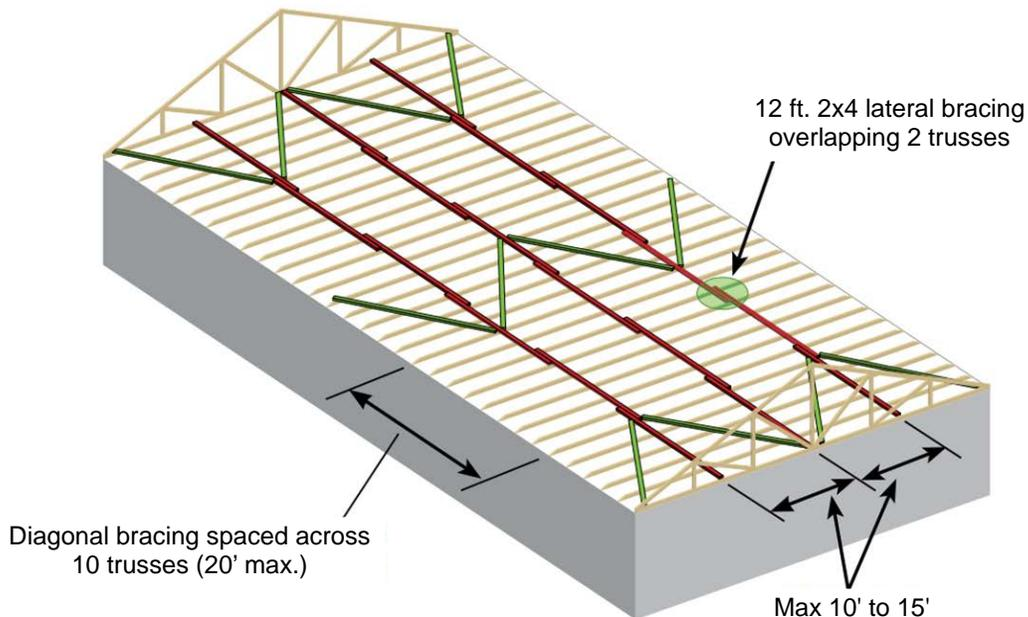

Figure 23 – Bracing at base of roof trusses, in horizontal plane (AQFSB, 2009a, b)

Figure 24 shows the bracing on the vertical and diagonal members of the roof trusses. This type of temporary bracing can be left in place permanently after the roof has been built and can be installed quickly because there are only a small number of parts to be nailed to the trusses.

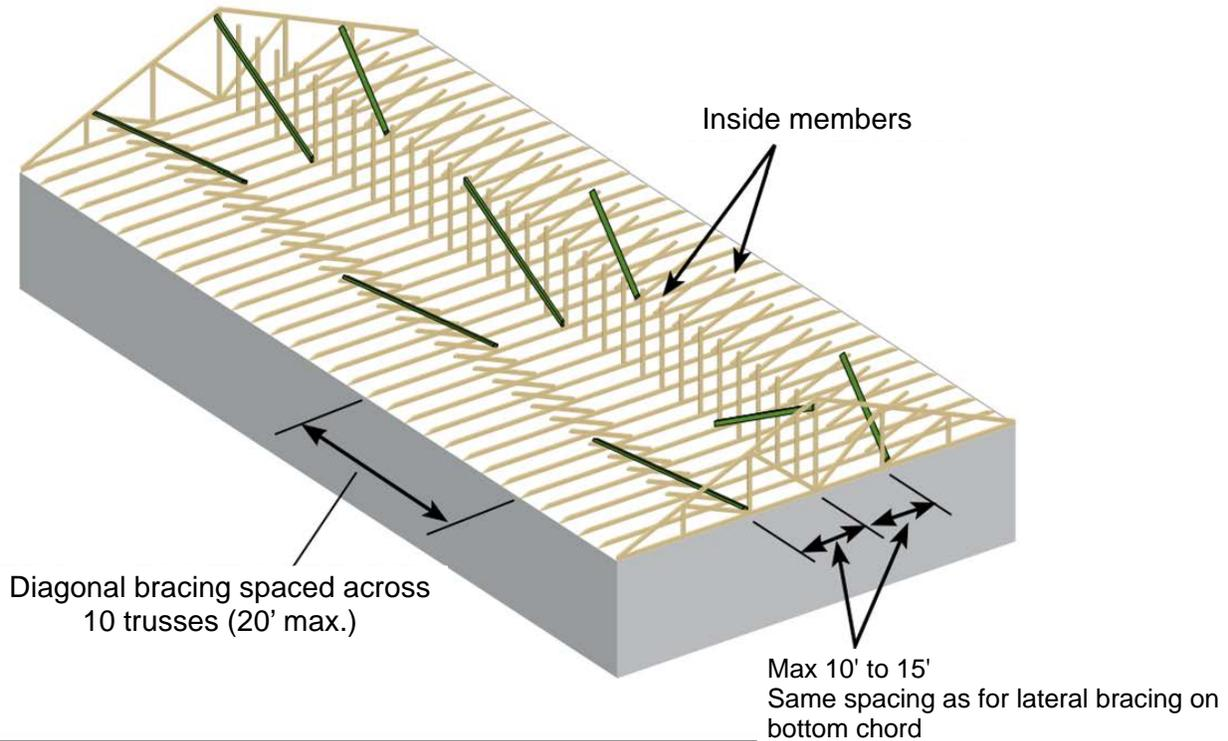

Figure 24 – Bracing on vertical and diagonal members of roof trusses (AQFSB, 2009a, b)

2.4.2.3 Initial Bracing

Initially, the plan was to brace the framework according to AQFSB or CECOBOIS recommendations, but the bracing installed on the framework erected in the lab did not correspond to their recommendations. The contractor said that the vast majority of residential housing builders did not follow those recommendations and did minimal bracing. So, rather than conduct a drop-testing campaign on a heavily braced structure that did not reflect common construction site reality, “realistic” bracing was opted for. As a result, the contractor braced the framework in the usual way, and the drop-testing campaign began.

When the first test with the HLLS was done, the bracing system failed partially. This bracing, referred to as “initial bracing” in the rest of this report, is illustrated in Figure 25.

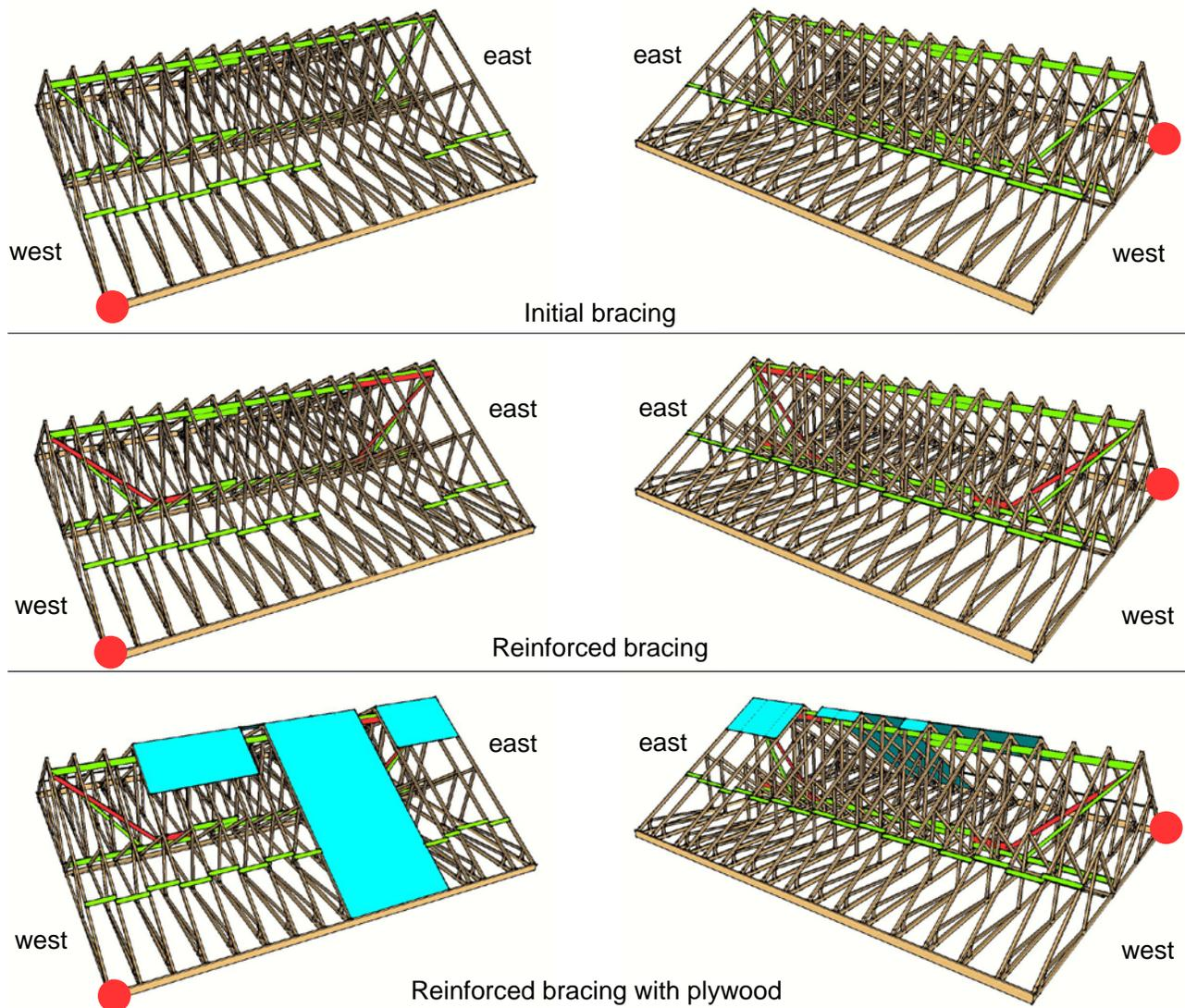

Figure 25 – Changes in bracing

It should be noted that, although the bracing failed partially, the drop of the wooden torso was arrested at a sufficient height to prevent any contact between the torso and the ground. Furthermore, the height was sufficient (close to six feet) to prevent a worker from hitting the ground under similar conditions. Following this unsuccessful attempt, the bracing was strengthened (indicated in red on Figure 25). The reinforced bracing is discussed in detail in the following section. Last, note that the structure tested for the HLLS included a few sheets of plywood [Figure 25]. The bracing installed on the rafters consisted of 1 in. x 3 in. lumber, while that installed on the vertical members of the roof consisted of 2 in. x 4 in. and 2 in. x 6 in. lumber. In addition, 2 in. x 6 in. lumber was installed at the edges of the roof.

2.4.2.4 Reinforced Bracing

The details of the reinforced bracing are shown in Figure 26. The 2 in. x 4 in. and 2 in. x 6 in. lumber for the initial bracing is indicated in green, while the 2 in. x 4 in. and 2 in. x 6 in. lumber that was added to strengthen the bracing following the test that caused the partial failure is marked in red. Figure 26 shows

that the bracing used was still very light in comparison with what is recommended by the AQFSB or the CECOBOIS. The bracing was primarily installed on the inside vertical members located at the centre of the roof trusses (with the exception of the 1 in. x 3 in. lumber installed on the rafters).

The reinforcement consisted in installing two more diagonal members, one at each end of the roof, in addition to those already in place. Aside from these two diagonals, several horizontal members were added to ensure continuity in the transmission of the horizontal forces: the members were placed end to end, as illustrated in Figure 26. This choice was based on the principle of the “continuous link” of Figure 27. The continuity of force transmission was therefore ensured from one end of the roof to the other.

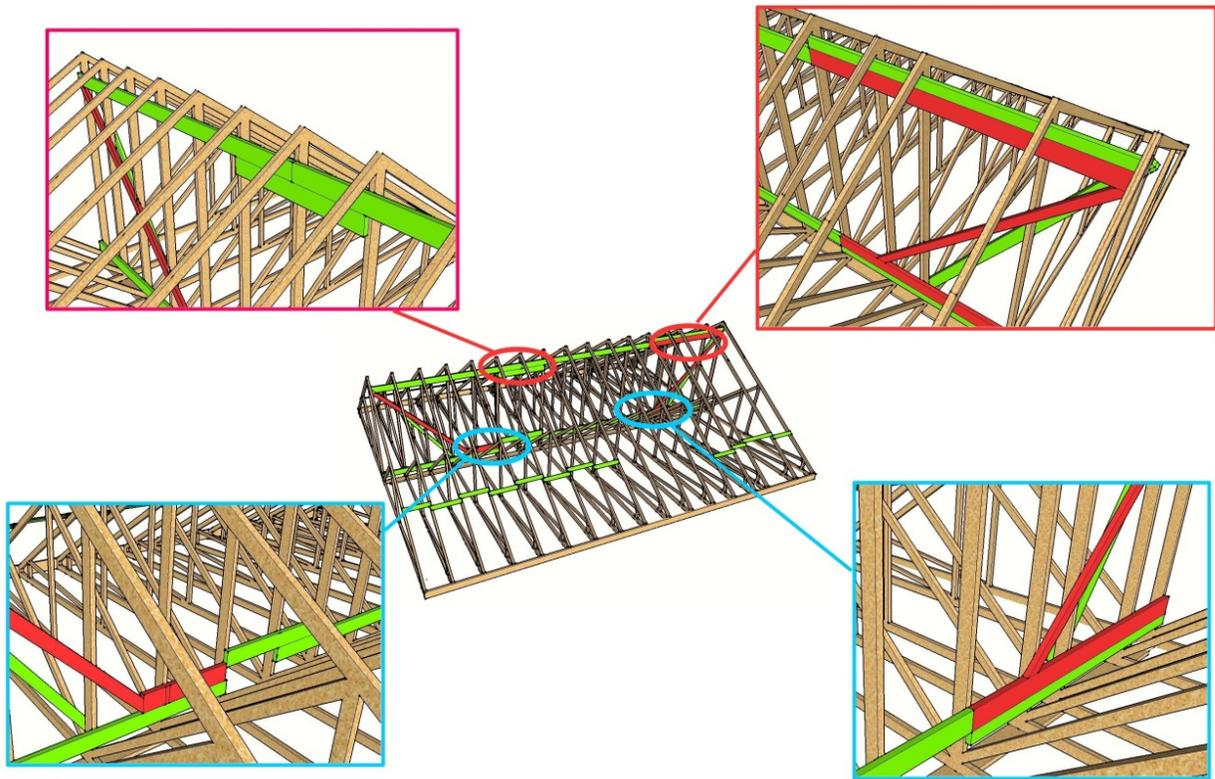

Figure 26 – Details of reinforced bracing (red)



Figure 27 – Members placed end to end to enhance horizontal force transmission

2.5 Dynamic Drop-Testing Program – Dynamic Performance and Strength Tests

The structural analysis hypothesis and the calculation method of standard CAN/CSA-S157 are based on the application of a static force at the top of the HLLS post. In reality, however, the post is subject to a dynamic impact load when an accidental fall is arrested. Thus, to simulate a real fall, dynamic drop testing was conducted in accordance with the test requirements of the CAN/CSA Z259 family of standards on fall protection. The DBI Sala Sayflite system used for the horizontal lifeline is a prefabricated product; as it had already been certified under the CAN/CSA Z259 standards, it did not require any further verification.

The drop-testing program had three distinct parts:

I. HLLS validation

- (i) Verification of the strength of the 127 mm x 127 mm x 6.4 mm HSS as an anchorage point for a worker's lanyard (sections 2.5.1 and 3.1);
- (ii) Verification of the strength of the 127 mm x 127 mm x 6.4 mm HSS as an anchorage post for an HLLS (sections 2.5.2 and 3.2).

II. Validation of braced trusses as an HLLS host structure

- (i) Verification of the strength of the braced trusses as a host structure for the posts that serve as anchorage points for a worker's lanyard (sections 2.5.3 and 3.3);
- (ii) Verification of the strength of the braced trusses as an HLLS host structure (sections 2.5.4 and 3.4).

III. Validation of braced trusses as a host structure for CAN/CSA Z259.15-certified single anchorage connectors (sections 2.5.5 and 3.5)

Validation of the HLLS, of braced trusses as an HLLS host structure, and of the anchorage connectors required two types of tests: performance tests and strength tests.

The dynamic performance tests were done by simulating real conditions of HLLS use with:

- A safety harness that complied with standard CAN/CSA Z259.10 *Full Body Harnesses* (CAN/CSA Z259.10, 2012);
- A lanyard with an E4 absorber compliant with standard CAN/CSA Z259.11 *Energy Absorbers and Lanyards* (CAN/CSA Z259.11, 2010);
- A 100 kg wooden torso compliant with standard CAN/CSA Z259.10 *Full Body Harnesses* (CAN/CSA Z259.10, 2012), dropped in a 1.2 m free fall.

The main performance criteria were:

- No failure;
- No release of the load or any HLLS equipment during the drop test;
- A total fall distance that would ensure that the available clearance was adequate to prevent a worker from striking the ground or any object resting on the ground during the arrest of an accidental fall.

The dynamic strength tests were done by simulating the conditions that place maximum loads on the HLLS with a 5/8 in. three-strand nylon rope lanyard without an energy absorber and a compact steel mass of 100 kg dropped in a 1.2 m free fall to simulate failure.

The main strength criteria were:

- No failure;
- No release of the load or any HLLS equipment during the drop test;
- Plastic deformation was permitted.

The tests were done following the standard methods recommended in the CAN/CSA Z259 standards on fall protection. These standards are commonly used to verify/validate HLLSs as part of IRSST projects focusing on fall protection (Lan and Daigle, 2011, 2008; Lan et al., 2004). Naturally, the tests are valid for all frameworks with several different pitches, braced according to AQFSB or CECOBOIS recommendations, since these bracing methods are stronger than that used for the testing.

2.5.1 Verification of Performance and Strength of 127 mm x 127 mm x 6.4 mm HSS as a Lanyard Anchorage Point

Three dynamic performance tests and three dynamic strength tests were conducted to assess the performance and verify the strength of the HLLS post as a lanyard anchorage. The tests were carried out by dropping a 100 kg mass with a 1.2 m free fall. The mass was connected by a lanyard, with or without an energy absorber, to the free end of the post. The post was a 127 mm x 127 mm x 6.4 mm aluminum HSS, 3.048 m in length, and anchored horizontally with a 1.524 m fixed end [Figure 28].

Figure 29 shows the experimental setup for the tests described in Table 3. The setup consisted of two columns, with bracing between them, that served to anchor the posts. Each anchorage column consisted of a 3.66 m high post anchored to the strong floor of the laboratory and a 5.33 m high vertical extension made from the same W310x253 steel section, bolted together to give a total height of 5.88 m.

Table 3 – Performance and strength tests of HLLS post as lanyard anchorage

Dynamic performance testing				
Tests	HLLS system	Anchorage	Parameters measured	Test and observation criteria
1 to 3	1. 127 mm x 127 mm x 6.4 mm (5 in. x 5 in. x ¼ in.) aluminum HSS post with a fixed-end installation of 1.524 m (60 in.) 2. Lanyard with integrated energy absorber compliant with CAN/CSA Z259.11-05 or self-retracting device with a fixed-end installation of 1.372 m (54 in.) 3. CSA Z259.10 harness 4. 100 kg wooden torso 5. Free-fall distance H = 1.2 m	Securely anchored to the lab structure with a fixed-end installation of 1.524 m (60 in.) with the lanyard having a fixed-end installation of 1.372 m (54 in.). Means of testing: 10 ft. long HSS, with the 5 ft. at the end secured with 2 or 3 clamps or jaws	1. Deformation of post (strain gauges used in 1 test out of 3) 2. Maximum arrest force of lanyard (load cell of lanyard in all 3 tests) 3. Deformation of energy absorber 4. Total fall distance to prevent steel mass from hitting floor or any material on floor	1. No failure or incipient failure/breakage of post 2. Plastic deformation permitted, but in no case release of the load 3. Observation of general behaviour of post
Dynamic strength testing				
Tests	HLLS system	Anchorage	Parameters measured	Test and observation criteria
4 to 6	Ditto with a 16 mm (5/8 in.) 3-strand nylon lanyard without energy absorber, 100 kg rigid steel mass	Ditto	1. Deformation of post 2. Maximum arrest force of lanyard (load cell of lanyard) 3. Total fall distance to prevent steel mass from hitting floor or any material on floor	Ditto

The centre-to-centre spacing between columns was 1 m. The four approximately 1.5 m long braces were made of 102 mm x 102 mm x 6.4 mm [4 in. x 4 in. x ¼ in.] L sections. They ensured composite bending action between the two vertical columns and increased the flexural rigidity of the setup as a whole. To minimize slippage at the post anchorages, two supports were added, in addition to the anchor plates, and placed in contact with the post (parts painted red in Figure 29 (b), (c) and (d)). The supports consisted of 102 mm x 102 mm x 6.4 mm [4 in. x 4 in. x ¼ in.] L sections. A 102 mm x 102 mm plate, 25.4 mm thick, was welded to the support located at the mid-span of the post to ensure contact with the post at the start of the fixed-end installation [Figure 29 (b) and (c)]. The two supports were bolted mechanically using a pneumatic drill, so as to maximize the resistance to slippage.

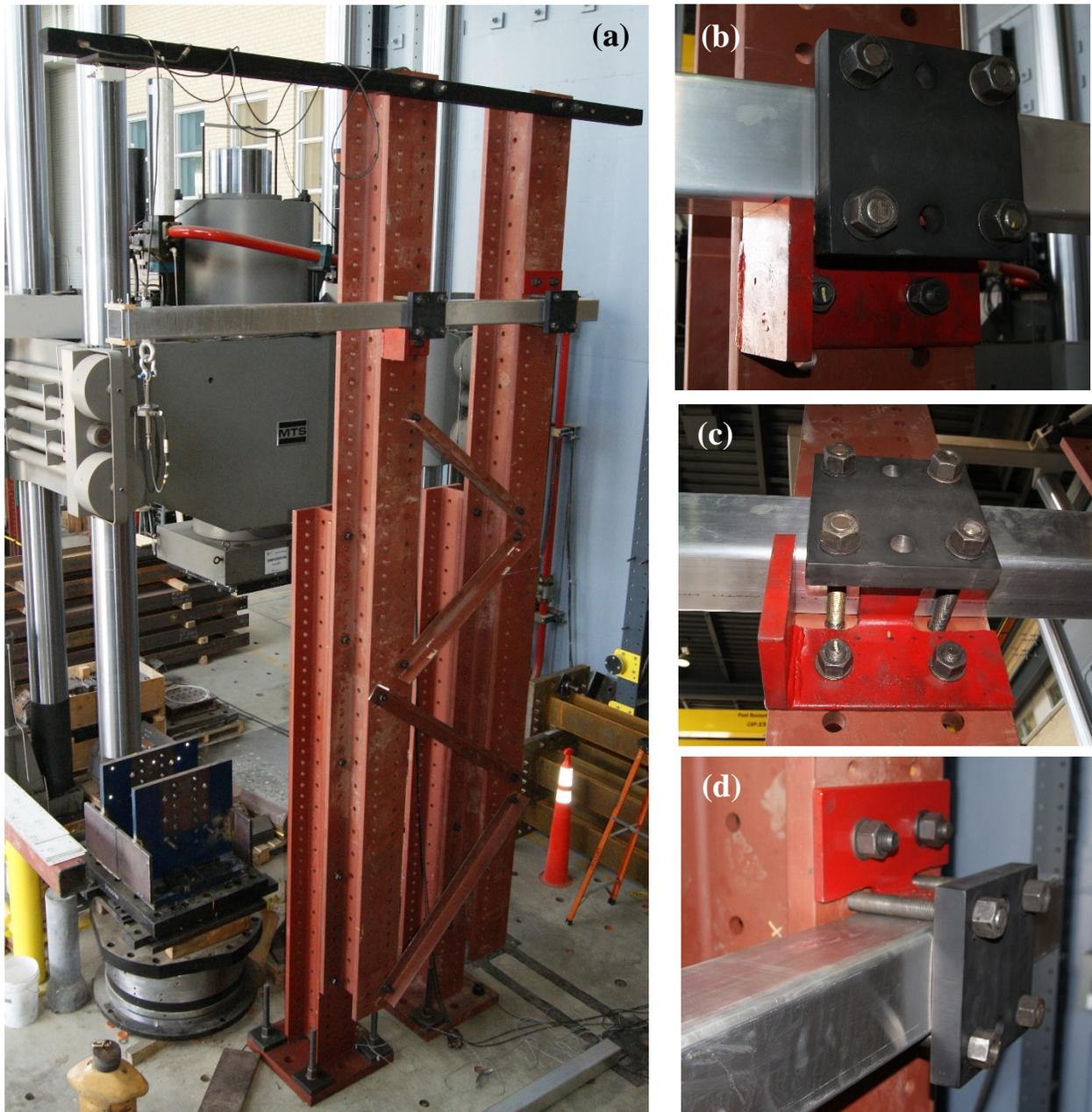

Figure 29 – Experimental setup to anchor posts for testing described in Table 3:
 (a) complete setup; (b) support at mid-span; (c) support at mid-span (view from below);
 (d) support at far end of fixed-end installation

2.5.2 Verification of Performance and Strength of 127 mm x 127 mm x 6.4 mm HSS as an HLLS Anchorage Post

Three dynamic performance tests and three dynamic strength tests were conducted to assess the performance and strength of the 10 ft., 127 mm x 127 mm x 6.4 mm HSS posts as an HLLS anchorage [Table 4]. The posts were set into a rigid fixed-end structure with a 1.524 m (60 in.) fixed end, spaced 10 m apart, with a DBI Sala Sayflines strung between them [Figure 30]. The DBI Sala Sayflines system is

equipped with a tension indicator. The initial tension of the cable was adjusted using the turnbuckle so that the tension indicator was in the range recommended by the manufacturer (which corresponds to an initial tension of around 2 kN).

Testing consisted in dropping a 100 kg mass in free fall for a distance of 1.2 m. The mass was connected to the midpoint of the Sayflite wire rope by a lanyard, with or without an energy absorber, to simulate a worker's fall [Table 4]. The parameters measured in real time, at a frequency of 1,200 Hz, included the maximum arrest force of the lanyard, cable sag, the fall distance of the wooden torso and the maximum anchorage force in the cable.

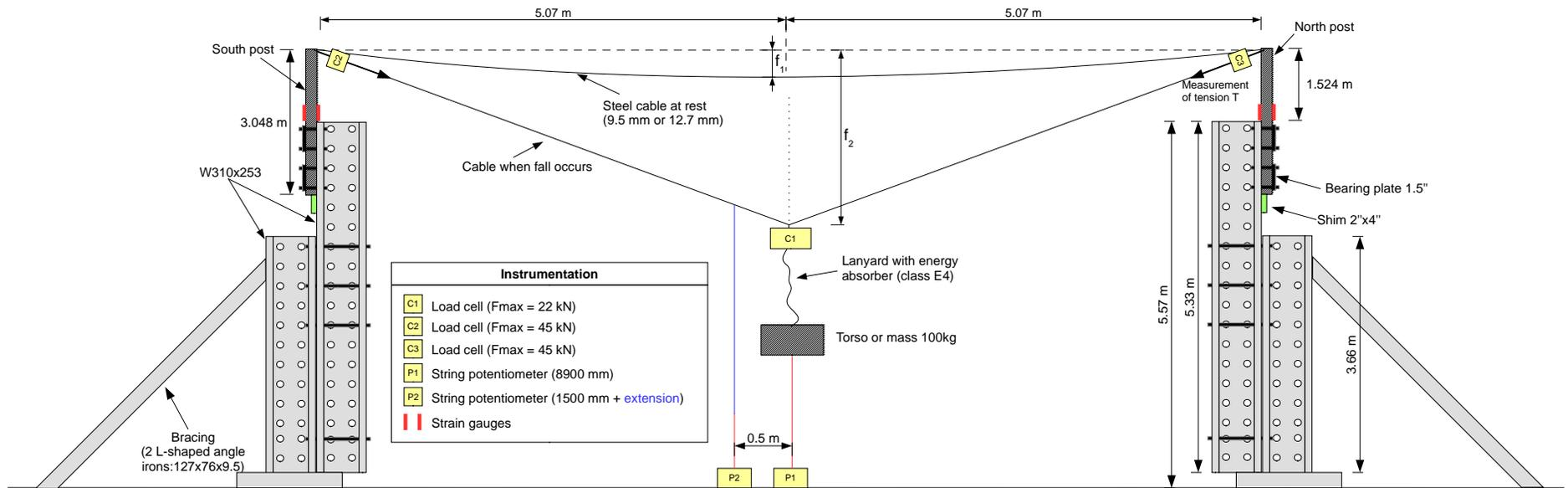

Figure 30 – Drawing of setup for validation testing of post as HLLS anchorage point

Table 4 – Verification of 127 mm x 127 mm x 6.4 mm HSS as HLLS anchorage post

Dynamic performance testing				
Tests	HLLS system	Anchorage	Parameters measured	Test and observation criteria
1 to 3	<ol style="list-style-type: none"> 1. HLL: DBI Sala Sayflite wire rope with adjustable span and DBI Zorbit 11.36 kN (2,500 lb) energy absorber 2. 10 ft., 127 mm x 127 mm x 6.4 mm (5 in. x 5 in. x ¼ in.) HSS aluminum posts, with a 1.524 m fixed end, and with the Sayflite having a fixed end of 1.37 m (54 in.) 3. Class A, CAN/CSA Z259.10-06-compliant harness 4. CAN/CSA Z259.11-05-compliant lanyard with integrated energy absorber or self-retracting device 5. Test mass: 100 kg wooden torso 6. Free-fall distance H = 1.2 m at mid-span 	Securely anchored to laboratory structure (5.5 m to 10 m, span between 2 laboratory columns)	<ol style="list-style-type: none"> 1. Deformation of posts (strain gauges used in 1 test out of 3) 2. Maximum arrest force of lanyard (load cell of lanyard in all 3 tests) 3. Displacement of mass 4. Deformation of energy absorbers 5. Maximum anchorage force (load cell) 6. Total fall distance to prevent steel mass from hitting floor or any material on floor 7. Deformation of HLLS 	<ol style="list-style-type: none"> 1. No failure or incipient failure of HLLS 2. No failure or incipient failure/breakage of any HLLS component 3. Plastic deformation permitted, but in no case release of the load 4. Total fall distance to ensure wooden torso does not hit the floor or any material on the floor 5. Observation of general behaviour of HLLS
Dynamic strength testing				
Tests	HLLS system	Anchorage	Parameters measured	Test and observation criteria
4 to 6	<p>Ditto except NO energy absorber in lanyard</p> <p>16 mm (5/8 in.) 3-strand nylon lanyard was used</p> <p>100 kg rigid steel mass</p>	Ditto	<ol style="list-style-type: none"> 1. Deformation of posts 2. Maximum arrest force of lanyard (load cell of lanyard) 3. Displacement of mass 4. Maximum anchorage force (load cell) 5. Total fall distance to prevent steel mass from hitting floor or any material on floor 6. Deformation of HLLS 	Ditto

To simulate as realistically as possible the desired fixed-end installation at the base of the posts, the posts were anchored to an anchorage column by means of two 203 mm x 203 mm x 38 mm [8 in. x 8 in. x 1½ in.] plates at the top of the anchorage column and at approximately the two-thirds point of the length of the post segment in contact with the anchorage column, starting from the top of the post segment in contact [Figure 31]. The post fixed end began above the anchorage column. In addition, a block of wood was secured to the anchorage column at the base of the posts to facilitate the setup and ensure the right fixed end of the posts during the testing.

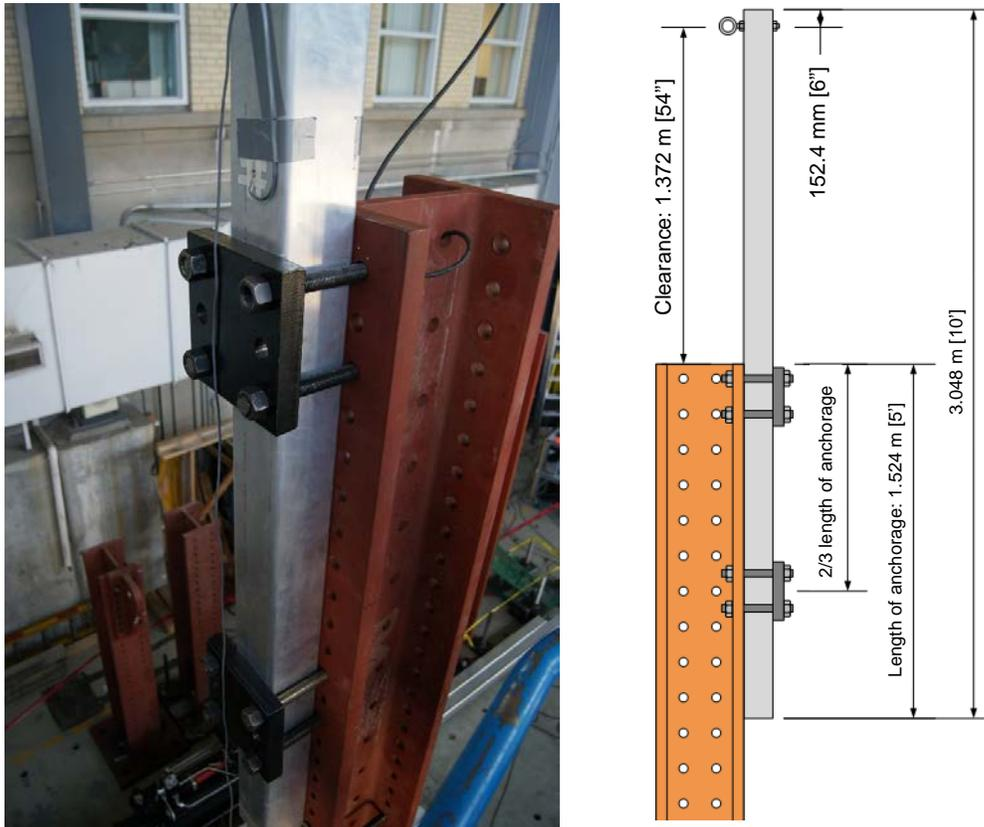

Figure 31 – Anchorage of posts to anchorage column

Two steel anchorage columns were assembled to which the posts could be secured. Each anchorage column consisted of a 3.66 m high post anchored to the strong floor of the laboratory and a 5.33 m high vertical extension. The post and the extension were made of the same W310x253 steel section. The two parts were bolted together to give a total height of 5.57 m. As the fixed end anchorage columns were relatively slender, a bracing system consisting of a diagonal member made of two 127 mm x 76 mm x 9.5 mm L sections set back to back was added to increase the lateral rigidity.

The lateral rigidity of the anchorage columns was measured in the lab. For this purpose, a 2 t chain hoist, a 45 kN load cell and a 500 mm string potentiometer were used. The lateral rigidity of an anchorage column was determined to be 17.8 kN/mm. This structural column rigidity was great enough that there would be no impact on the results of the dynamic drop testing.

2.5.3 Verification of Performance and Strength of Braced Trusses as Host Structure of a Post for Anchoring a Lanyard

To assess the strength of braced trusses as a host structure of an HLLS post serving to anchor a worker’s lanyard, three dynamic performance tests and three dynamic strength tests were conducted with the post secured to a braced roof truss [Table 5]. The tests consisted in dropping a 100 kg mass in free fall from a height of 1.2 m, attached by a lanyard with or without an energy absorber to the free end of the post anchored with a 1.524 m fixed end to a braced roof truss [Figure 32]. The parameters measured in real time, at a frequency of 1,200 Hz, included the maximum arrest force of the lanyard and the fall distance of the wooden torso. The structure of braced trusses is described in detail in chapter 2, section 2.4.

Table 5 – Verification of strength of braced trusses as host structure of a post for anchoring a lanyard

Dynamic performance testing				
Tests	HLLS system	Anchorage	Parameters measured	Test and observation criteria
1 to 3	1. 16 ft., 127 mm x 127 mm x 6.4 mm (5 in. x 5 in. x ¼ in.) aluminum HSS post with a 1.524 m (60 in.) fixed end secured to one truss of a set of five braced trusses 2. Class A, CAN/CSA Z259.10-06-compliant harness 3. CAN/CSA Z259.11-05-compliant lanyard with integrated energy absorber, or self-retracting device 4. Test mass: 100 kg wooden torso 5. Free-fall distance H = 1.2 m at mid-span	Securely attached to one truss of a set of 5 braced trusses	1. Deformation of post (strain gauges used in 1 test out of 3) 2. Maximum arrest force of lanyard (load cell of lanyard in all 3 tests) 3. Deformation of energy absorber 4. Total fall distance to prevent steel mass from hitting floor or any material on floor	1. No failure or incipient failure/breakage of post 2. Plastic deformation allowed, but in no case release of the load 3. Observation of general behaviour of post
Dynamic strength testing				
Tests	HLLS system	Anchorage	Parameters measured	Test and observation criteria
4 to 6	Ditto with a 16 mm (5/8 in.) 3-strand nylon lanyard without energy absorber 100 kg rigid steel mass	Ditto	1. Deformation of post 2. Maximum arrest force of lanyard (load cell of lanyard) 3. Total fall distance to prevent steel mass from hitting floor or any material on floor	Ditto

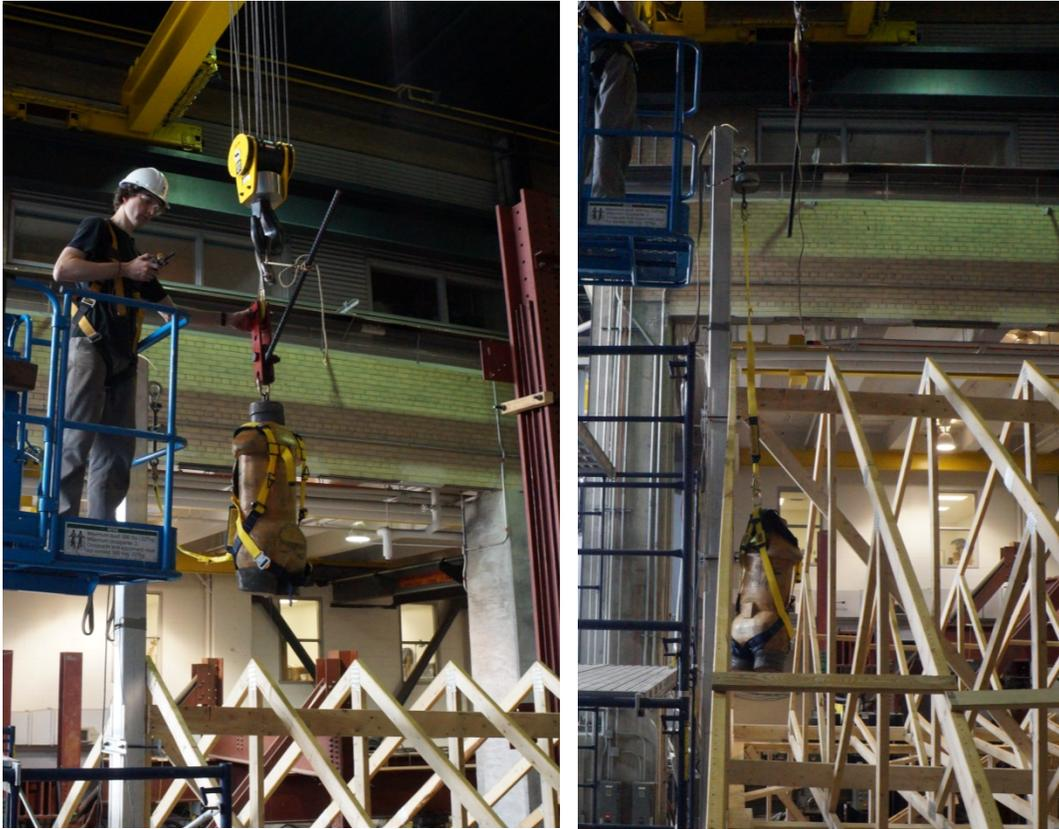

Figure 32 – Verification of strength of a braced truss as host structure of a post for anchoring a lanyard

Figure 33 is a drawing of the test setup showing the positions of the measuring instruments. The load cell used to measure force during a fall arrest was installed between the eye bolt and the lanyard. On the ground, a string potentiometer served to measure the vertical displacement of the test mass. These two measurement devices were connected to a data acquisition system that recorded measurements at 1,200 Hz.

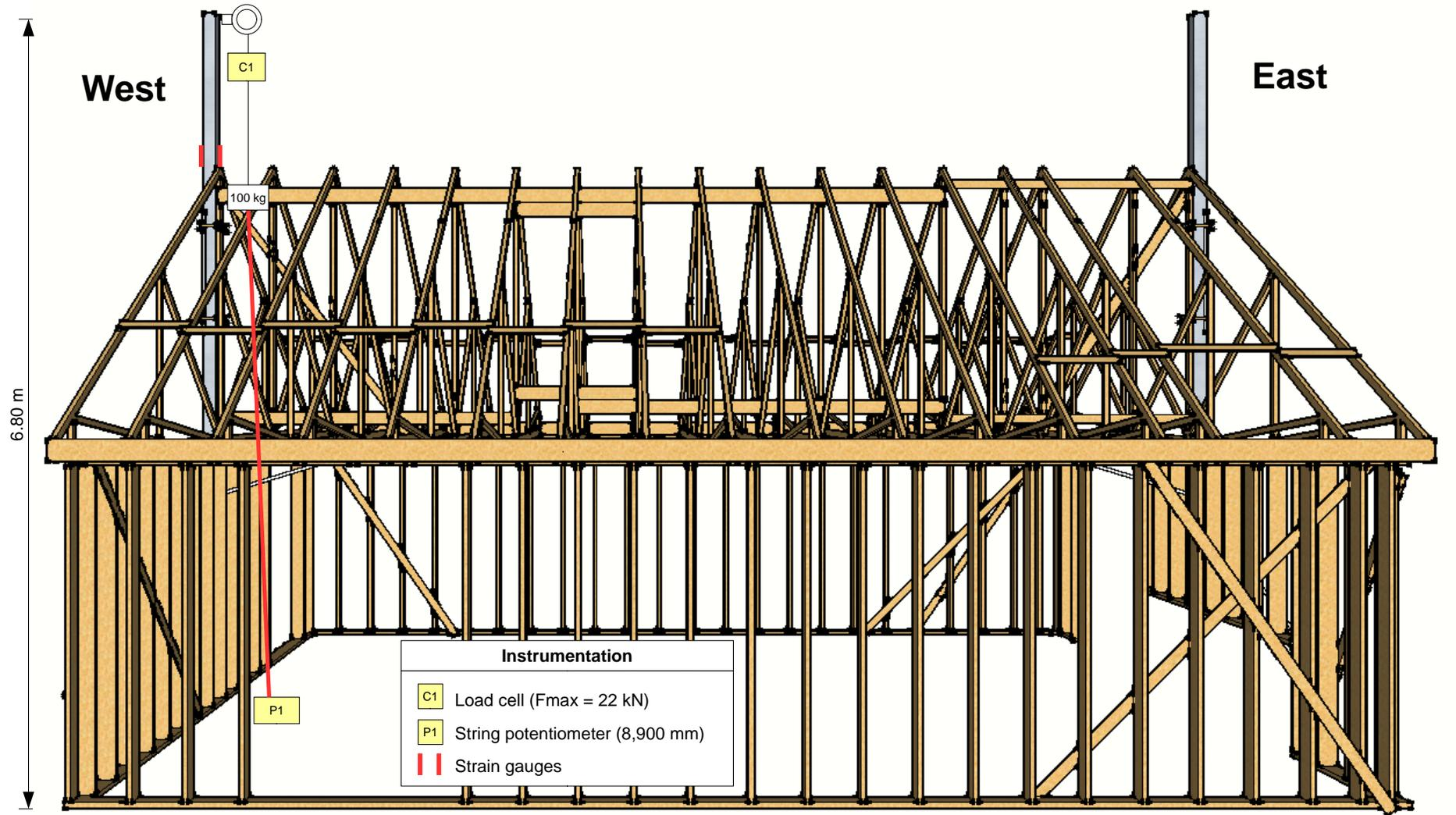

Figure 33 – Illustration of setup for validation testing of host structure for a post as a single anchorage

2.5.4 Verification of Performance and Strength of Braced Trusses as Host Structure of an HLLS

To assess the performance and strength of the braced trusses as a host structure of an HLLS, three dynamic performance tests and three dynamic strength tests [Table 6] were conducted with a DBI Sala Sayflite, installed with a span of 10 m between the HLLS posts made of 16 ft. long 127 mm x 127 mm x 6.4 mm HSSs. The posts were secured to the two end trusses of the braced roof with the HLLS assembly equipment [Figure 7]. The tests involved dropping a 100 kg mass in free fall from a height of 1.2 m at mid-span of the Sayflite to simulate a worker's fall. The mass was connected to the midpoint of the Sayflite span by a lanyard with or without an energy absorber [Figure 34]. The parameters measured in real time, at a frequency of 1,200 Hz, included the maximum arrest force of the lanyard, the fall distance of the wooden torso and the maximum anchorage force at the two ends of the cable. The characteristics of the house framework reconstructed in the lab are described in detail in chapter 2.

Table 6 – Verification of strength of braced trusses as host structure of an HLLS

Dynamic performance testing				
Tests	HLLS system	Anchorage	Parameters measured	Test and observation criteria
1 to 3	<ol style="list-style-type: none"> 1. HLL: DBI Sala Sayflin wire rope with adjustable span and DBI Zorbit 11.36 kN (2,500 lb) energy absorber 2. 16 ft., 127 mm x 127 mm x 6.4 mm (5 in. x 5 in. x ¼ in.) HSS aluminum posts, with a 1.524 m fixed end, and with the Sayflin having a fixed end of 1.37 m (54 in.) 3. Class A, CAN/CSA Z259.10-06-compliant harness 4. CAN/CSA Z259.11-05-compliant lanyard with integrated energy absorber or self-retracting device 5. Test mass: 100 kg wooden torso 6. Free-fall distance H = 1.2 m at mid-span 	<p>Anchored to the braced trusses following industry practices without plywood, ideally between second and second-to-last truss, span to be measured on site</p> <p>Note: If test 1 is successful, repair any damage to the roof, so that tests 2, 3 and 4 can be conducted under the same conditions as test 1</p>	<ol style="list-style-type: none"> 1. Deformation of posts 2. Maximum arrest force of lanyard (load cell) 3. Displacement of mass 4. Deformation of energy absorbers 5. Maximum anchoring force 6. Total fall distance to prevent steel mass from hitting floor or any material on floor 7. Deformation of HLLS 	<ol style="list-style-type: none"> 1. No failure or incipient failure of HLLS 2. No failure or incipient failure/breakage of any HLLS components 3. Plastic deformation allowed, but in no case release of the load 4. Total fall distance to ensure wooden torso does not hit the floor or any material on the floor 5. Observation of general behaviour of HLLS
Dynamic strength testing				
Tests	HLLS system	Anchorage	Parameters to be measured	Test and observation criteria
4 to 6	<p>Ditto except NO energy absorber in lanyard 16 mm (5/8 in.) 3-strand nylon lanyard was used 100 kg rigid steel mass</p>	Ditto	Ditto	Ditto

Figure 34 is a drawing of the test setup showing the positions of the measuring instruments. The load cell (C1) used to measure the force in the lanyard during a fall arrest was connected between the cable and the lanyard. On the ground, a string potentiometer (P1) served to measure the vertical displacement of the test mass. A load cell was installed at each end of the cable to measure the tension during the fall arrest (C2 and C3). These two measurement devices were connected to a data acquisition system that recorded measurements at 1,200 Hz. Test 1 of Table 6 was conducted following configuration 1 of Figure 35, while subsequent tests 2 to 6 were carried out according to configuration 2 (with reinforced bracing) of Figure 35.

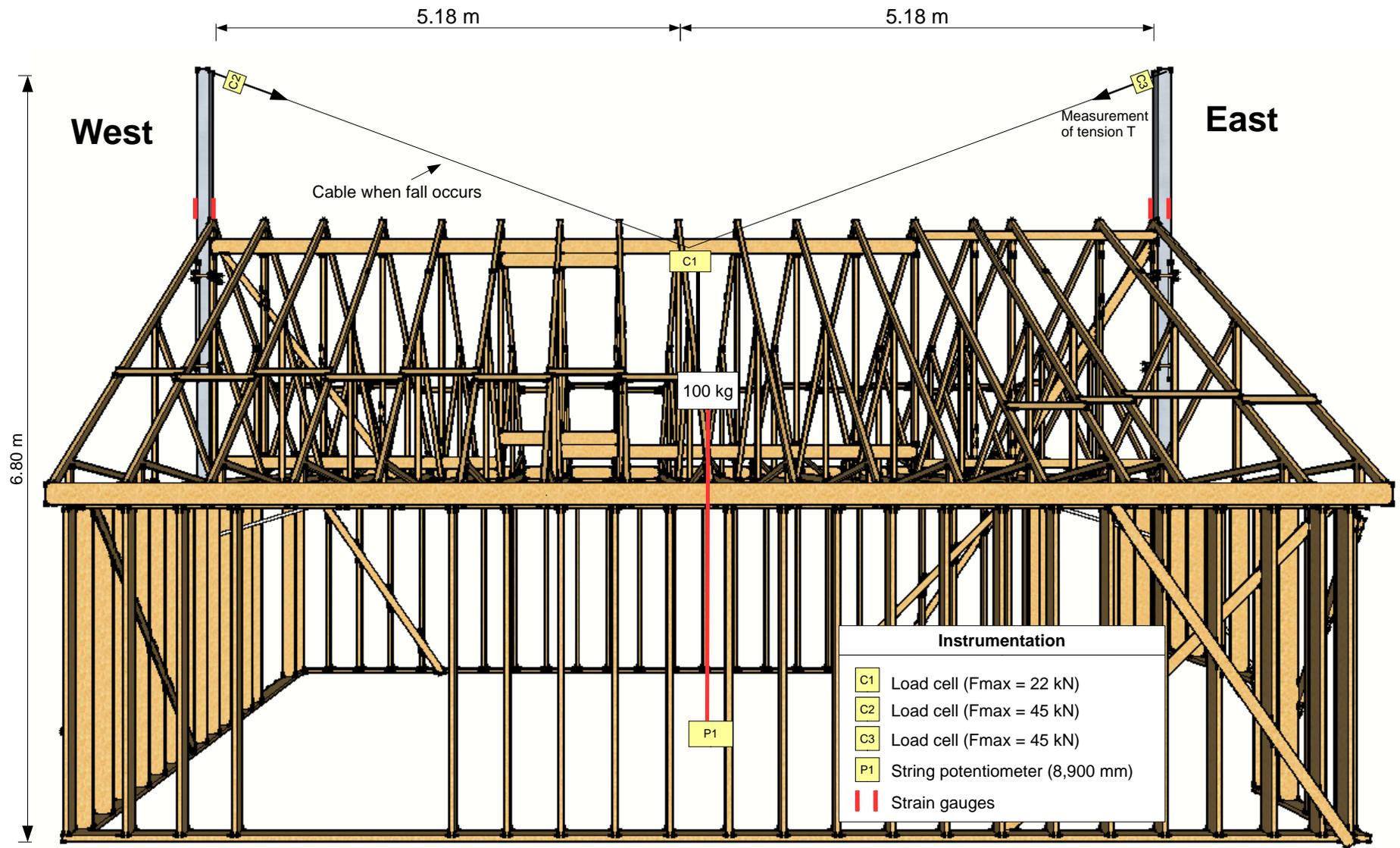

Figure 34 – Illustration of setup for validation testing of HLLS host structure

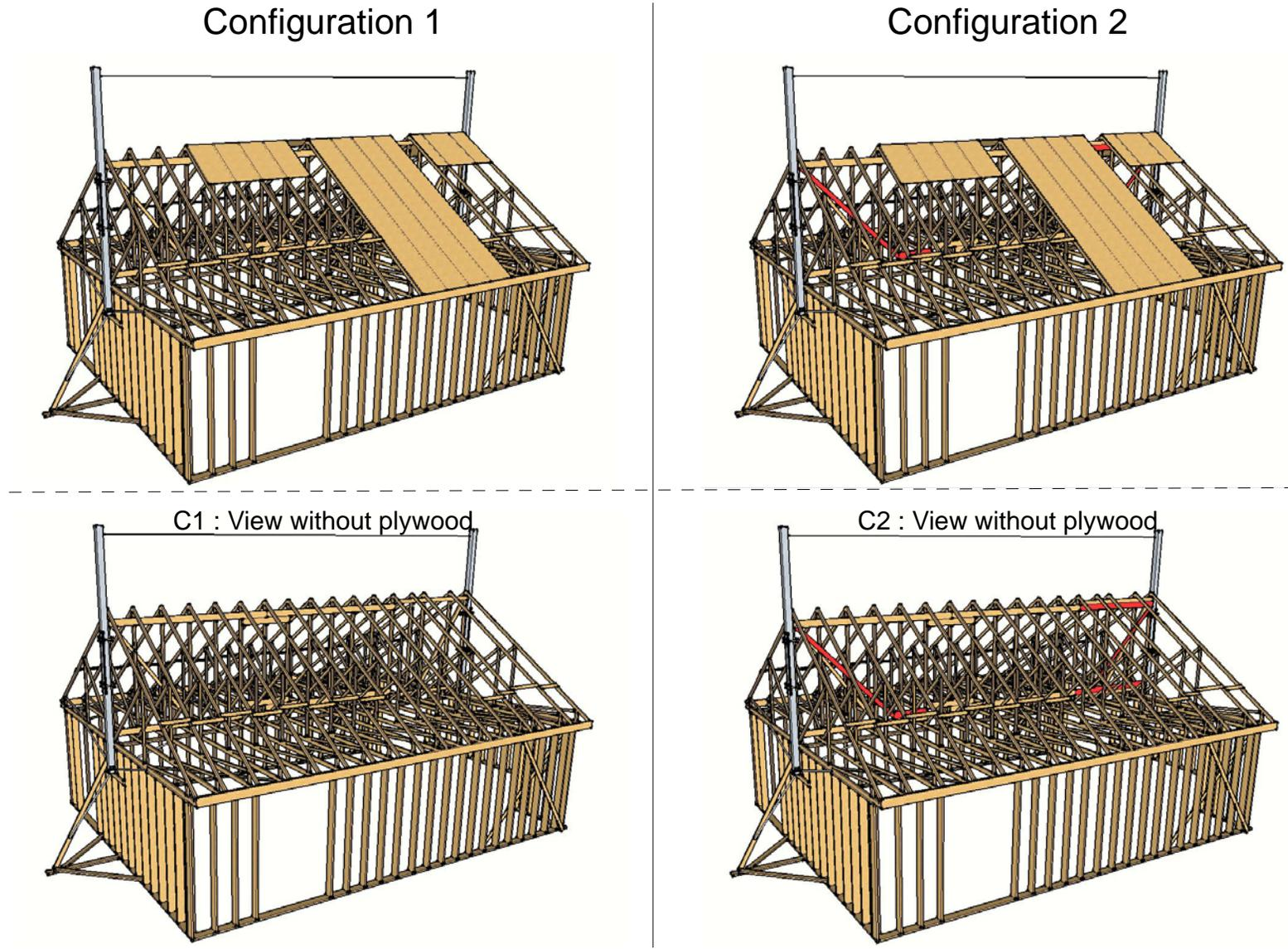

Figure 35 – Illustration of configurations for validation testing of HLLS host structure

2.5.5 Verification of Performance and Strength of Braced Trusses as Host Structure for CAN/CSA Z259.15-Certified Anchorage Connectors

Since the publication of standard CAN/CSA Z259.15 – *Anchorage connectors* in 2012, roofers have been increasingly using anchorage connectors to secure fall protection or restraint systems on roofs [Figure 36]. The structure erected in the lab was used to conduct dynamic fall testing to assess its strength as a host structure for CAN/CSA Z259.15-certified anchorage connectors used for working on wood roofs. In total, 3 of the 6 anchorage connectors most commonly used by roofers were tested. The connectors were chosen through a survey of AMCQ and APCHQ members and CNESST inspectors.

Strength testing was done in accordance with clause 8.2.3.3 – *Initial dynamic strength test procedure* of standard CAN/CSA Z259.15 [Figure 36]. The main test accessories used were:

- a) A test lanyard at least 1.2 m (4 ft.) long made from 25 mm (1 in.) wide polyester webbing. It must not stretch more than 200 mm (8 in.) when subjected to a force of 20 kN (4,500 lbf) for 10 seconds;
- b) The 100 kg (220 lb) rigidly constructed test mass must be raised up so that it can travel a distance of 2.4 m (8 ft.) in free fall when dropped by means of a quick release mechanism.

Figure 36 is a drawing of the test setup showing the positions of the measuring instruments. The load cell (C1) used to measure the force in the lanyard during a fall arrest was connected between the anchorage connector and a 9.5 mm cable attached to the lanyard. On the ground, a string potentiometer (P1) served to measure the vertical displacement of the test mass. These measurement devices were connected to a data acquisition system that recorded measurements at 1,200 Hz.

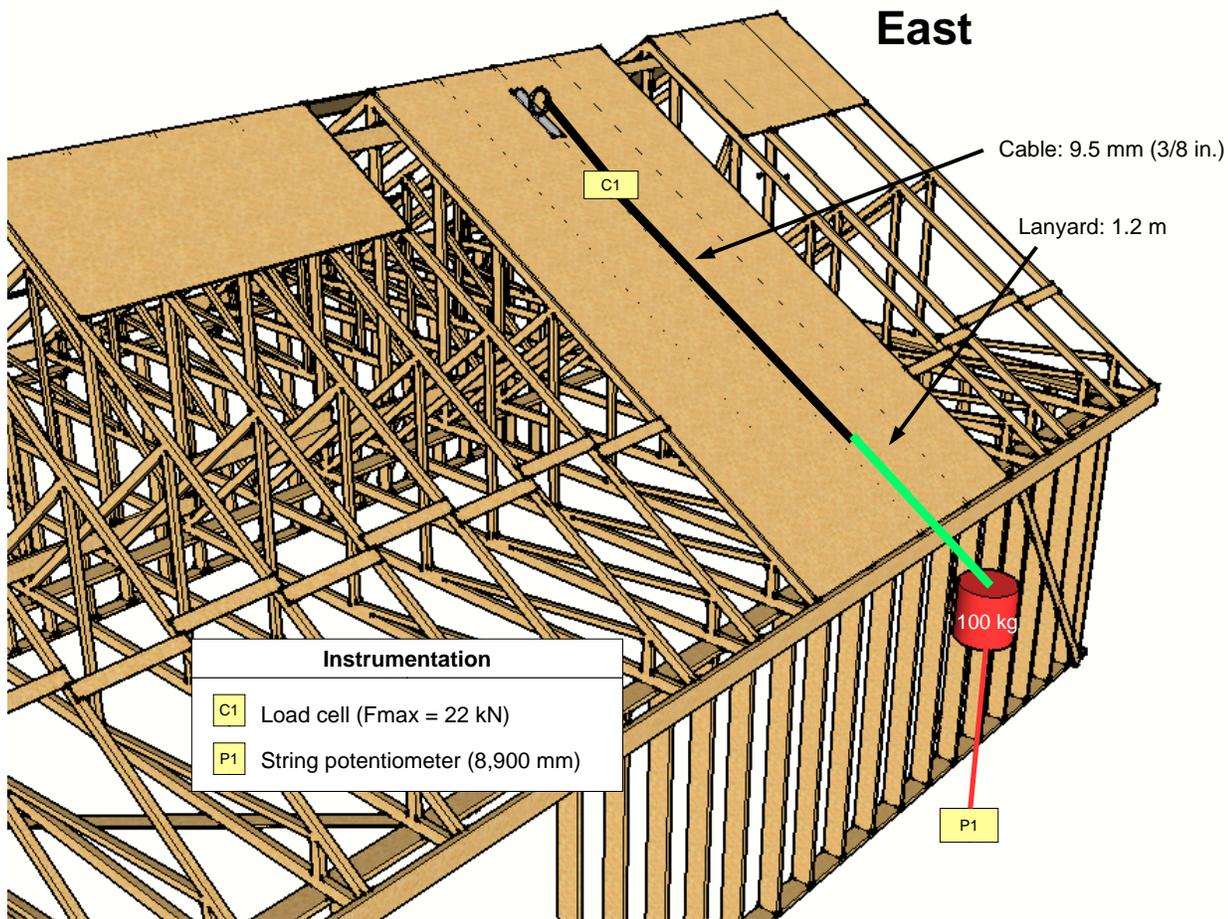

Figure 36 – Dynamic drop testing

For each anchorage connector, the tests described in Table 7 were conducted. The first test had to be successful for the subsequent tests to be carried out:

- Three performance tests with the anchor base secured to a truss rafter (case 1), using a lanyard with energy absorber, a 100 kg mass and a free-fall distance of 1.2 m. Case 1 represents the usual recommended usage.
- One performance test with the anchor base secured to plywood (case 2), using a lanyard with energy absorber, a 100 kg mass and a free-fall distance of 1.2 m. Case 2 represents an incorrect installation of the anchorage connector by a distracted worker.
- Three strength tests with anchor base secured to a rafter (case 3), using a CAN/CSA Z259.11-compliant lanyard without energy absorber, a 100 kg mass and a free-fall distance of 2.4 m.

For each test, the force of the lanyard and the position of the mass in free fall were recorded in real time, at a frequency of 1,200 Hz.

Table 7 – Verification of strength of braced trusses as host structure for CAN/CSA Z259.15-certified anchorage connectors

Dynamic performance testing				
Tests	Host structure	Anchorage	Parameters measured	Test and observation criteria
1 to 3	1. Reconstructed roof 2. CAN/CSA Z259.11-05-compliant lanyard with integrated energy absorber or self-retracting device 3. Test mass: steel, 100 kg 4. Free-fall distance $H = 1.2$ m at edge of roof Note: 1 test out of 3 with CSA Z259-compliant harness and 100 kg wooden torso	Truss rafters/plywood 1 test at ridge and 2 others on plywood	1. Maximum arrest force of lanyard (load cell of lanyard in all 3 tests) 2. Deformation of energy absorber 3. Total fall distance to prevent steel mass from hitting floor or any material on floor	1. No failure or incipient failure of host structure 2. Plastic deformation permitted, but in no case release of the load 3. Observation of behaviour of system
4 Tests 5 and 6 done if test 4 successful	1. Reconstructed roof 2. CAN/CSA Z259.11-05-compliant lanyard with integrated energy absorber or self-retracting device 3. Test mass: steel, 100 kg 4. Free-fall distance $H = 1.2$ m at edge of roof Note: 1 test out of 3 with CSA Z259-compliant harness and 100 kg wooden torso	Plywood	1. Maximum arrest force of lanyard (load cell of lanyard in first 3 tests) 2. Deformation of energy absorber 3. Total fall distance to prevent steel mass from hitting floor or any material on floor	1. No failure or incipient failure of host structure 2. Plastic deformation permitted, but in no case release of the load 3. Observation of behaviour of system
Dynamic strength testing (failure)				
Tests	Host structure	Anchorage	Parameters measured	Test and observation criteria
7 to 9	1. Reconstructed roof 2. CAN/CSA Z259.15-compliant test lanyard 3. Test mass: steel, 100 kg 4. Free-fall distance $H = 2.4$ m at edge of roof	Truss rafters/plywood	1. Maximum arrest force of lanyard (load cell of lanyard in the 3 tests) 2. Total fall distance to prevent steel mass from hitting floor or any material on floor	Ditto
10 Test conducted if test 4 successful	If test 4 successful, carry out test 10 under the same conditions as test 7	Plywood	Ditto	Ditto

For the three anchors, test 3 was identical to test 2 except that the number of nails used per anchor leg was reduced from 10 to 3 for each leg of the Protecta and DBI anchors and from 4 to 2 for each leg of the Ridge anchors [Figure 37]. In addition, the nails were not driven in all the way, which is common practice in residential construction so that they are easier to pull out afterwards.

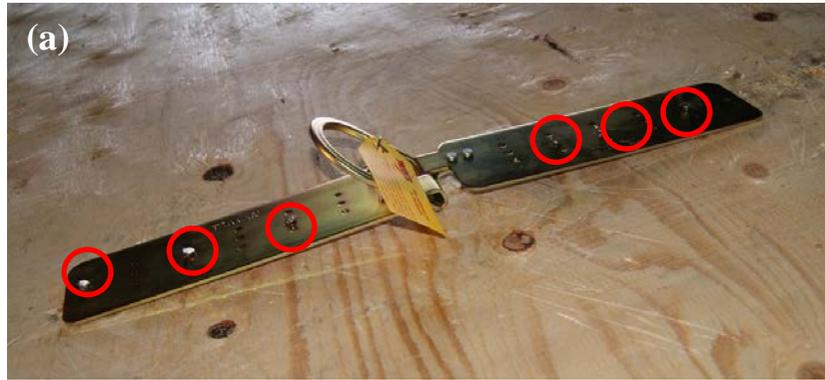

Figure 37 – Nailing of anchorage connectors for test 3 of Table 7: (a) Protecta, (b) DBI, (c) Ridge

3. RESULTS

The test results and photos are taken from the technical report on the tests conducted by Polytechnique Montréal.⁵

3.1 Performance and Strength of 127 mm x 127 mm x 6.4 mm HSS as a Lanyard Anchorage Point

Three performance tests and three strength tests were conducted to determine the performance and strength of the 3.048 m (10 ft.) long HLLS post made of 127 mm x 127 mm x 6.4 mm aluminum HSS, having a 1,372 mm (54 in.) fixed end, as a lanyard anchorage point. Table 8 summarizes the results of the tests described in Table 3.

Table 8 – Results of performance and strength testing of 127 mm x 127 mm x 6.4 mm HSS post as a lanyard anchorage

Performance testing: 1.2 m lanyard, E4 energy absorber, 100 kg wooden torso, Class A harness and free-fall distance of 1.2 m								
Test	Free-fall distance (m)	Lanyard + harness			Post			Harness impact indicator stitches ripped
		Stretch		Max. arrest force (kN)	Max. deflection (mm)	Strain gauges		
		Max. (mm)	Final (mm)			Compression (µm/m)	Tension (µm/m)	
1	1.2	668	644	3.59	19.9	-830	879	2 out of 2
2	1.2	702	679	3.67	15.1			0 out of 2
3	1.2	718	686	4.13	16.1			2 out of 2
Av.	1.2	696	670	3.79	17.0			
Strength testing: 1.2 m, 5/8 in. three-strand nylon lanyard, no energy absorber, 100 kg rigid mass and free-fall distance of 1.2 m								
Test	Free-fall distance (m)	Lanyard + harness			Post			Harness impact indicator stitches ripped
		Stretch		Max. arrest force (kN)	Max. deflection (mm)	Strain gauges		
		Max. (mm)	Final (mm)			Compression (µm/m)	Tension (µm/m)	
4	1.2	185	58.4	10.28	42.6	-1,758	1,910	N/A
5	1.2	182	49.0	10.53	39.6			N/A
6	1.2	160	46.1	8.74	35.4			N/A
Av.	1.2	176	51.1	9.85	39.2			

Figure 38 shows the typical experimental setup for the testing, i.e., test 3 before [Figure 38 (a)] and after [Figure 38 (b)] the triggering of the drop of the wooden torso. A significant slip occurred during test 1,

5. M. Leclerc and R. Tremblay, 2015, *Évaluation d'un système de corde d'assurance horizontale et ancrages utilisés lors de la pose de toitures résidentielles*, Project CDT/Report ST15-03, Department of Civil, Geological and Mining Engineering, Polytechnique Montréal.

causing a residual deflection of the order of 5 mm, even though the anchorages had been tightened properly and blocks had been put in place. For the other tests, residual deflection remained relatively small. Figure 39 shows the number of safety harness fall arrest indicators that were activated in test 3. During test 2, in contrast, no fall arrest indicator was activated. Figure 40 illustrates typical free-fall distance and maximum arrest force recorded in test 3.

The results of tests 1 to 3 were fairly identical, except the deflection of the post in test 1, which was greater because of the slippage of the supports. The E4 energy absorber helped to limit the maximum arrest force to less than 4 kN, except in test 3, in which a maximum arrest force of 4.13 kN was recorded. During strength testing with the 5/8 in. three-strand nylon lanyard, the average maximum arrest force was 9.85 kN (tests 4 to 6). The posts equipped with strain gauges highlighted the fact that the post remained in the elastic range during the fall arrest.

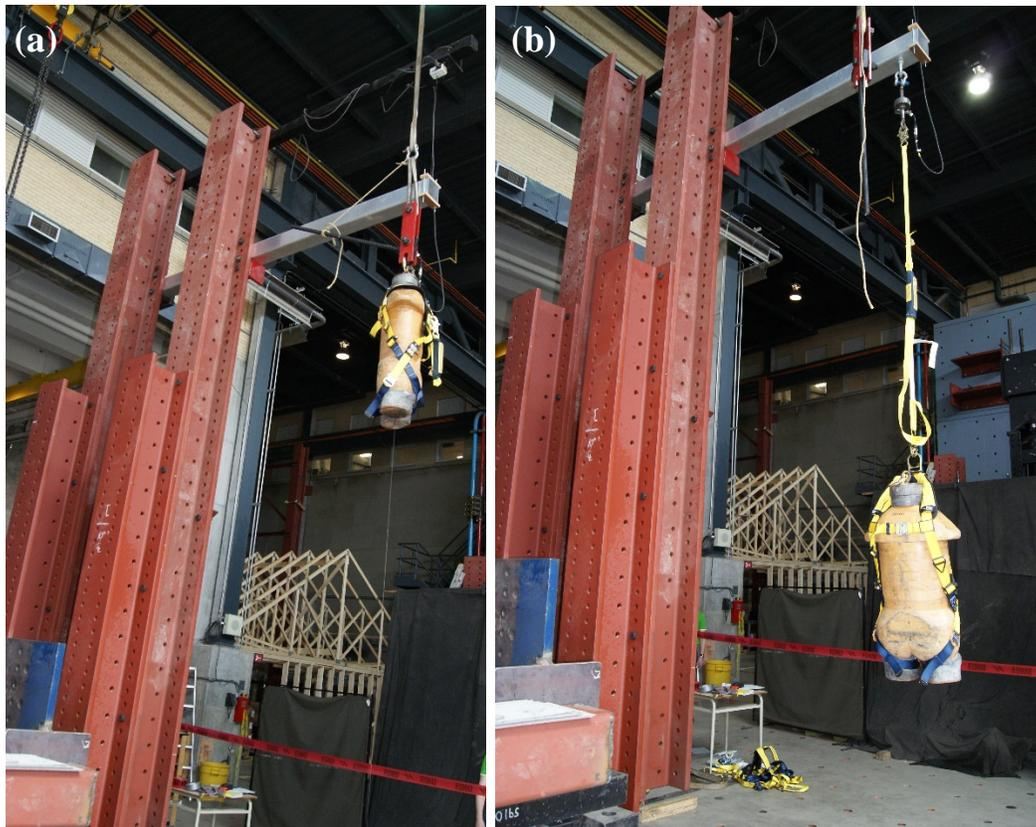

Figure 38 – Table 3, test 3: (a) before and (b) after triggering drop of wooden torso



Figure 39 – Safety harness fall arrest indicators: (a) activated; (b) not activated

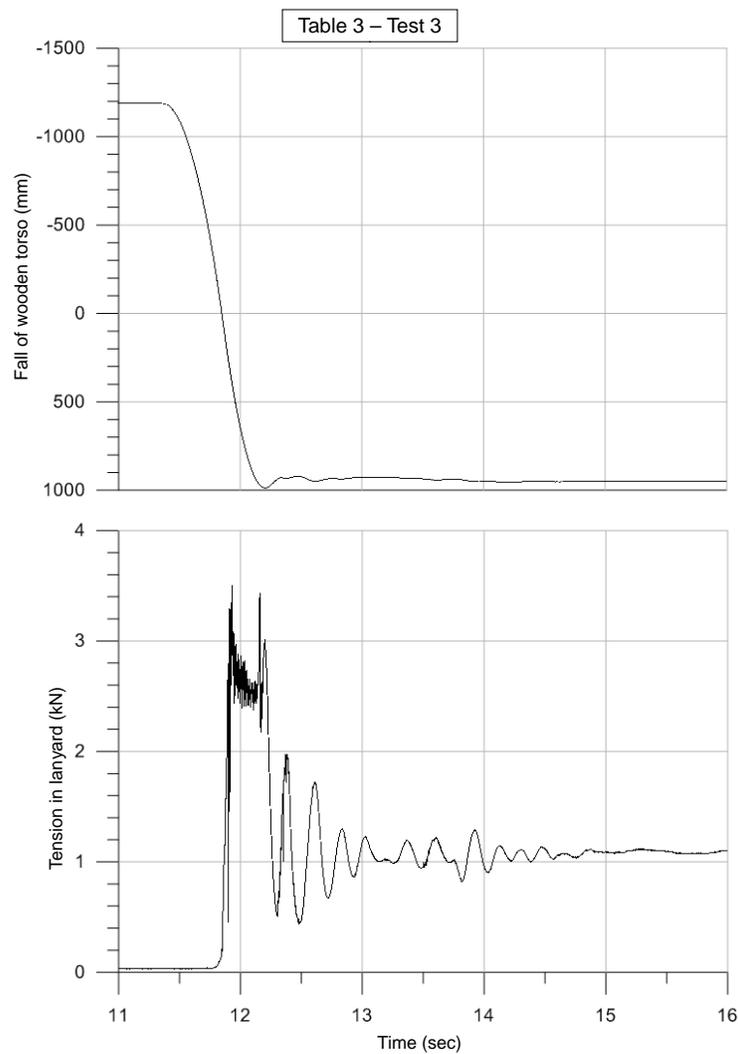

Figure 40 – Free-fall distance and maximum arrest force for test 3 (typical curves)

Figure 41 shows the deflection of the post in relation to the force exerted on the lanyard during the fall for test 1 (with energy absorber). It can be seen that the behaviour is highly nonlinear, which is to be expected, given that a Class E4 energy absorber was used in test 1 of Table 3.



Figure 41 – Test 1: force in lanyard and deflection of post

The post showed a residual deflection at the end of the test, which was due to the weight of the suspended wooden torso. When the wooden torso was raised up, the strain gauges went back to 0, and the residual deflection was 1 mm, which corresponds to a displacement of the securement system at the end of the post.

Figure 42 shows the force exerted in the lanyard in the fall for test 4 (without energy absorber) in relation to deflection of the post. The behaviour shows a slight nonlinearity. A residual displacement of around 4 mm was seen when the wooden torso was raised up after the drop test. This permanent deformation is consistent with the microdeformation levels recorded during the fall, of the order of 2,000 $\mu\text{m}/\text{m}$, i.e., greater than the elastic limit, which is approximately 1,500 $\mu\text{m}/\text{m}$.

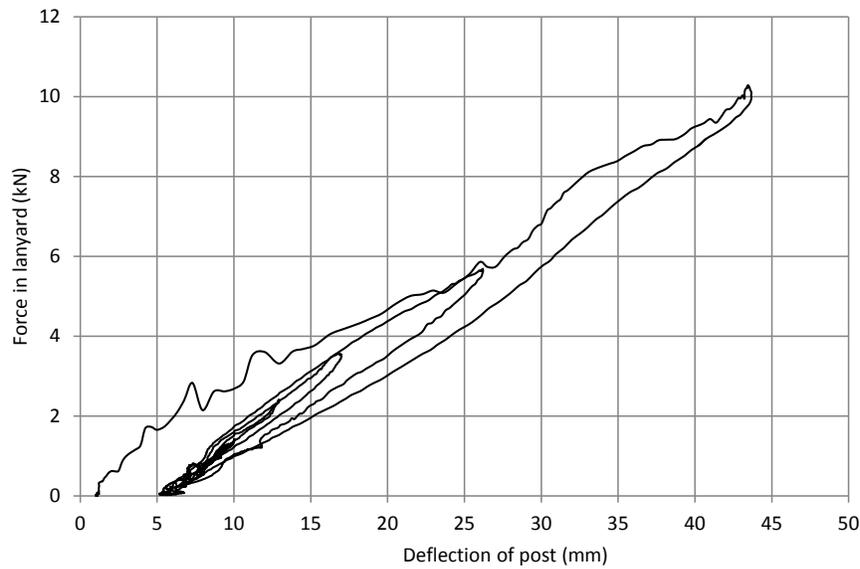

Figure 42 – Test 4: force in lanyard and deformation of post

3.2 Performance and Strength of 127 mm x 127 mm x 6.4 mm HSS as an HLLS Anchorage Post

Three performance tests and three strength tests were conducted to determine the performance and strength of the 3.038 m (10 ft.) long HLLS post made of 127 mm x 127 mm x 6.4 mm aluminum HSS, having a 1,371.6 mm (54 in.) fixed end, as the HLLS anchorage. Table 9 summarizes the results of the tests described in Table 4.

Table 9 – Results of performance and strength testing of 127 mm x 127 mm x 6.4 mm HSS as an HLLS anchorage post

Performance testing: 1.2 m lanyard, E4 energy absorber, 100 kg wooden torso, Class A harness and free-fall distance of 1.2 m at mid-span of HLLS										
Test	Free-fall distance (m)	Lanyard + harness				Cable				Harness impact indicator stitches ripped
		Stretch			Maximum arrest force (kN)	Max. sag (mm)	Maximum tension		Zorbit deployment (no. of rips)	
		Max. (mm)	Final (mm)	Lanyard (mm)			West (kN)	East (kN)		
1	1.2	882	737	673	3.42	728	11.07	11.14	1	0 out of 2
2	1.2	927	778	654	3.49	713	10.44	10.49	1	1 out of 2
3	1.2	916	771	699	3.36	732	10.99	10.99	1	0 out of 2
Av.	1.2	908	762	678	3.42	724	10.84	10.87	1	
Strength testing: 1.2 m, 5/8 in. three-strand nylon lanyard, no energy absorber, 100 kg rigid mass and free-fall distance of 1.2 m at mid-span of HLLS										
Test	Free-fall distance (m)	Lanyard + harness				Cable				Harness impact indicator stitches ripped
		Stretch			Maximum arrest force (kN)	Max. sag (mm)	Maximum tension		Zorbit deployment (no. of rips)	
		Max. (mm)	Final (mm)	Lanyard (mm)			West (kN)	East (kN)		
4	1.2	286	103	83	4.79	1,099	13.26	11.60	13	N/A
5	1.2	264	110	64	4.39	1,077	12.18	11.43	14	N/A
6	1.2	170	51	57	4.47	1,060	13.49	11.57	13	N/A
Av.	1.2	240	88	68	4.55	1,079	12.98	11.53	13	

Figure 43 shows the standard experimental setup for the testing described in Table 4, i.e., test 5 before [Figure 43 (a)] and after [Figure 43 (b)] triggering the drop of the wooden torso.

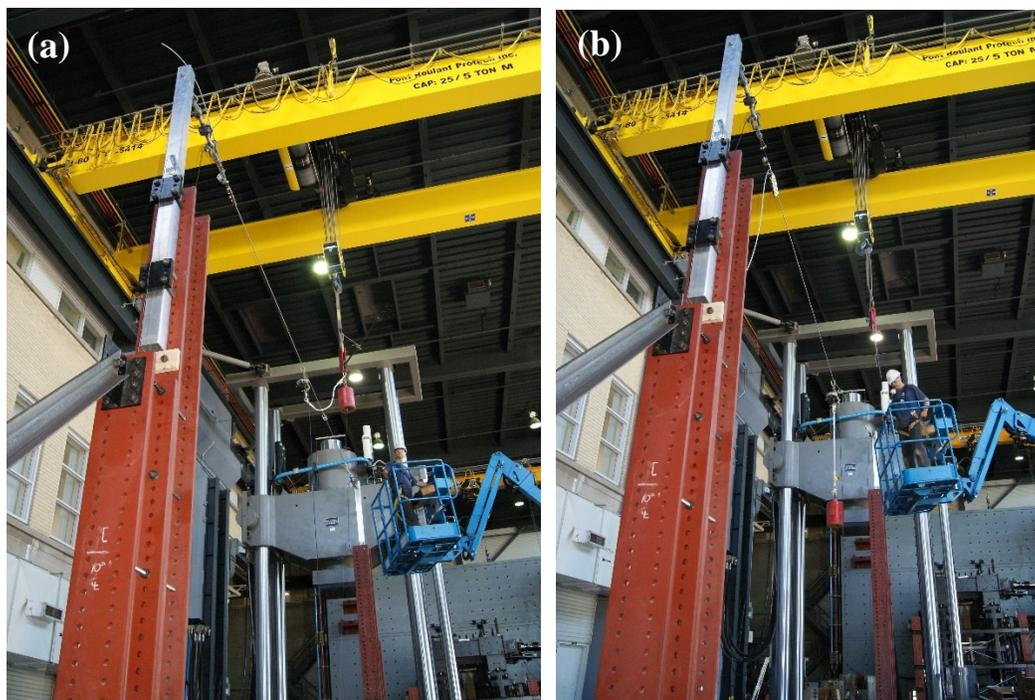

Figure 43 – Table 4, test 5: (a) before and (b) after triggering drop of wooden torso

Tests 4 to 6 showed that the Sayflite lifeline system alone cannot limit the maximum arrest force in the 5/8 in. three-strand nylon lanyard to less than 4 kN, although it comes close to that limit. With a post alone, the average maximum arrest force was 9.85 kN [Table 8]. These results confirm that the HLLS has sufficient flexibility to allow the energy of the fall to dissipate. Another point worth noting is that the Zorbit energy absorber limited the maximum anchorage forces to approximately 11 kN in tests 1 to 6. However, the deployment of the Zorbit absorber was greater in tests 4 to 6, i.e., 13 rips in comparison with 1 [Table 9].

The results also indicated that the mechanism that was the most active in dissipating fall energy was the lanyard with the E4 energy absorber. Most of the harness fall indicators (five out of six) did not show ripped stitches. Figure 44, Figure 45 and Figure 46 illustrate the deployment and number of rips of the Zorbit system noted in tests 4 to 6 of Table 4.



Figure 44 – Deployment of Zorbit system with 13 rips in test 4 of Table 4



Figure 45 – Deployment of Zorbit system with 14 rips in test 5 of Table 4



Figure 46 – Deployment of Zorbit system with 13 rips in test 6 of Table 4

Figure 47 shows the force-deformation diagram for the post for the dynamic drop testing with the wooden torso and energy absorber. It can be seen that the post's behaviour is perfectly linear, which means that the Zorbit energy absorber placed on the horizontal lifeline did not deploy. In fact, the force in the cable remained below 11 kN.

Figure 48 gives the force-deformation diagram for the post for the dynamic drop testing with a metal mass and a nylon lanyard without an energy absorber. Note that the behaviour is nonlinear, meaning that the Zorbit energy absorber deployed (as was confirmed following the drop test). It perfectly fulfilled the purpose for which it was designed, keeping the tension in the cable below 12 kN at the east end of the cable. These findings were also valid for the Table 4 tests conducted on the wooden structure in the lab.

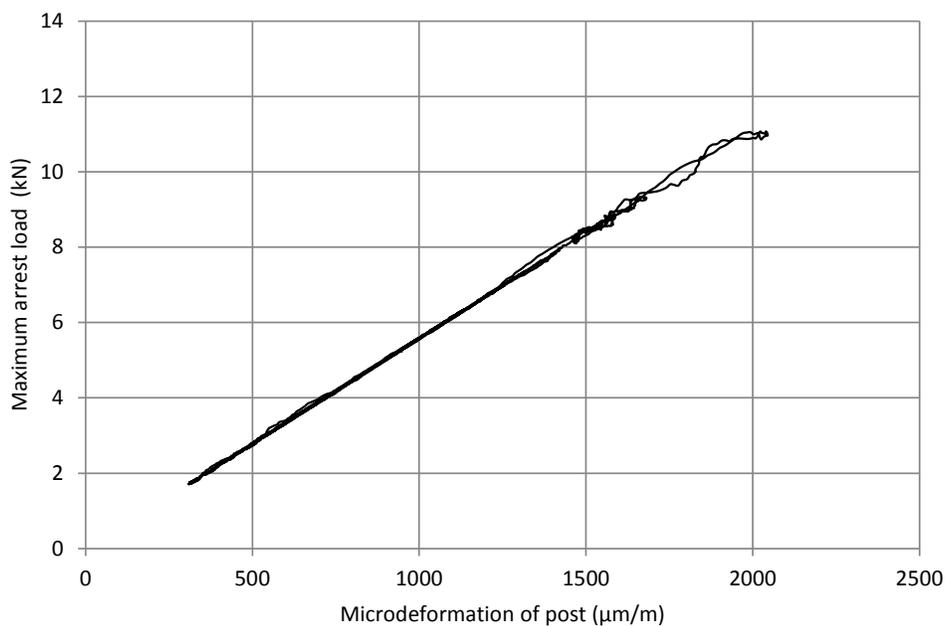

Figure 47 – Test 1: tension in cable and deformation of post

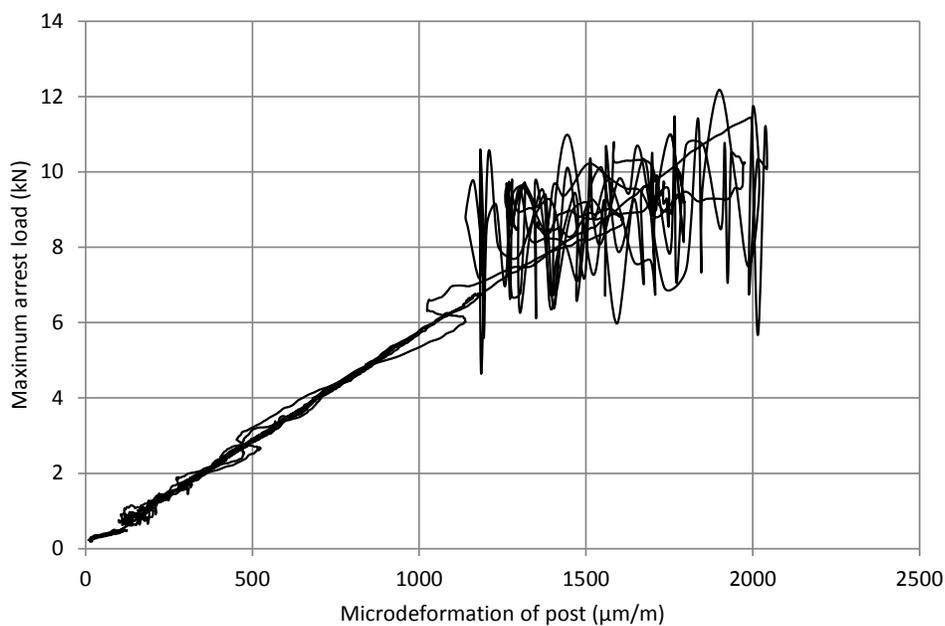

Figure 48 – Test 5: tension in cable and deformation of post

3.3 Performance and Strength of Braced Trusses as Host Structure of a Post for Anchoring a Lanyard

Three performance tests and three strength tests were conducted to determine the performance and strength of the braced trusses as a host structure for post 2 of the HLLS, made of a 4.878 m (16 ft.) long

aluminum HSS (127 mm x 127 mm x 6.4 mm) secured to the central upright of a braced truss having a 1,372 mm (54 in.) fixed end, serving as the lanyard anchorage point. Figure 49 shows the standard setup for this series, i.e., test 4, before [Figure 49 (a)] and after [Figure 49 (b)] triggering the drop of the steel mass.



Figure 49 – Table 5, test 4: (a) before test, (b) after test

Table 10 gives the results of the tests described in Table 5. The maximum arrest forces measured in the lanyards with an energy absorber were lower than 4 kN, while they were of the order of 10 kN on average in the 5/8 in. three-strand nylon lanyards without an energy absorber. The posts, equipped with strain gauges, all remained within the elastic range. Four harness fall indicators out of six did not rip. During test 4, the bracing of the host structure gave way and the structure suffered slight damage to the roof ridge beam [Figure 50].

Table 10 – Results of performance and strength testing of braced trusses as a host structure for a lanyard

Performance testing: 1.2 m lanyard, E4 energy absorber, 100 kg wooden torso, Class A harness and free-fall distance of 1.2 m						
Test	Free-fall distance (m)	Lanyard + harness		Post		Harness impact indicator stitches ripped
				Strain gauges		
		Max. stretch (mm)	Max. arrest force (kN)	Compression (µm/m)	Tension (µm/m)	
1	1.2	1,028	3.36			0 out of 2
2	1.2	940	3.94	-211	191	2 out of 2
3	1.2	950	3.51			0 out of 2
Av.	1.2	972	3.60			
Strength testing: 1.2 m, 5/8 in. three-strand nylon lanyard, no E4 energy absorber, 100 kg rigid mass and free-fall distance of 1.2 m						
Test	Free-fall distance (m)	Lanyard + harness		Post		Harness impact indicator stitches ripped
				Strain gauges		
		Max. stretch (mm)	Max. arrest force (kN)	Compression (µm/m)	Tension (µm/m)	
4	1.2	304	10.24			N/A
5	1.2	289	9.30	-419	355	N/A
6	1.2	280	9.02			N/A
Av.	1.2	291	9.52			



Figure 50 – Slight damage to host structure following test 4 of Table 5

3.4 Performance and Strength of Braced Trusses as Host Structure of an HLLS

Three performance tests and three strength tests were conducted to determine the performance and strength of the braced trusses as an HLLS host structure, with two HLLS posts made of two 4.878 m (16 ft.) long aluminum HSSs (127 mm x 127 mm x 6.4 mm) secured to the central uprights of the end braced trusses, with a 1,372 mm (54 in.) fixed end of the HLLS. Figure 51 shows the typical setup for the Table 6 series of tests, i.e., test 5 before [Figure 51 (a)] and after [Figure 51 (b)] triggering the drop of the steel mass.

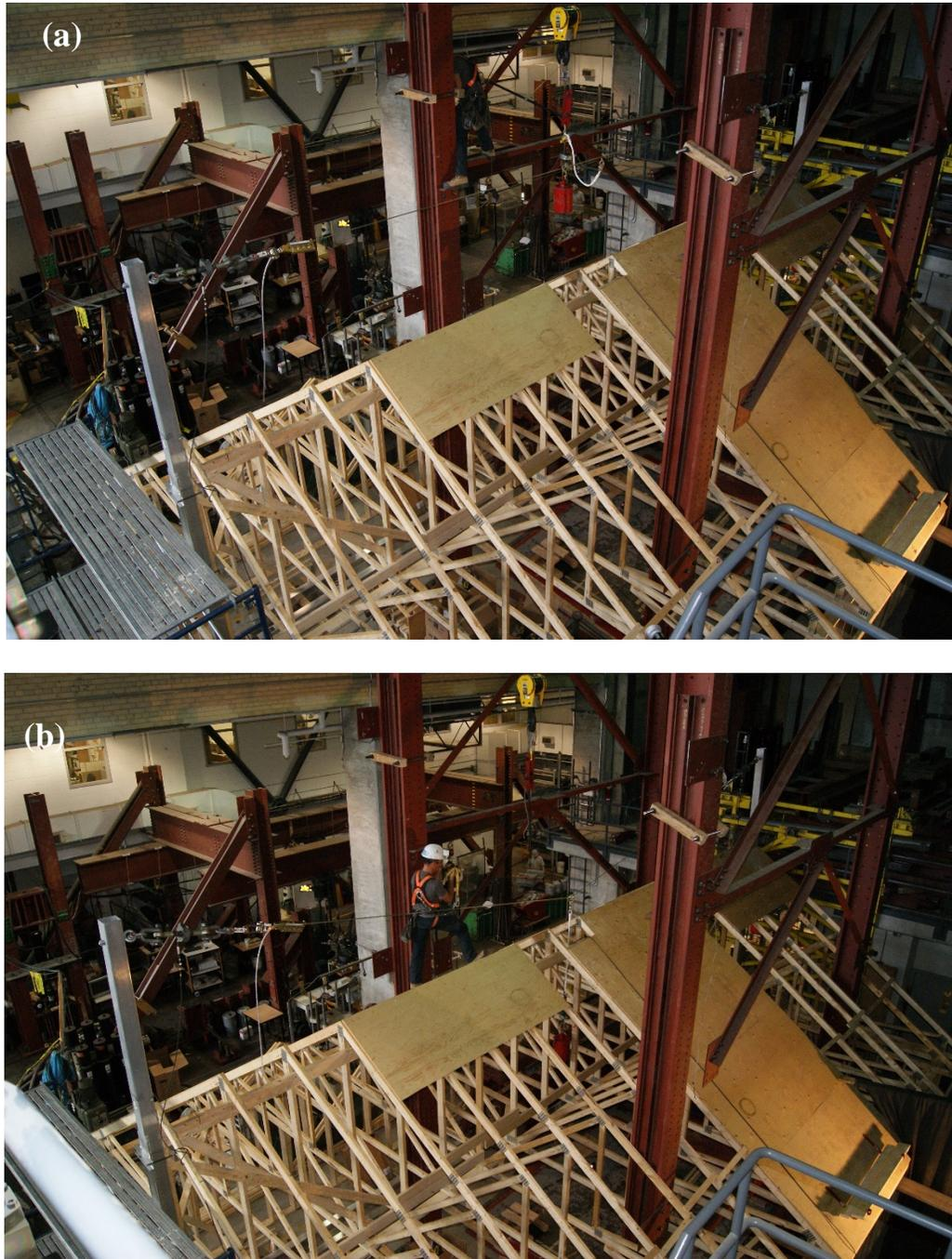

Figure 51 – Test 5: (a) before and (b) after triggering drop of steel mass

Table 11 summarizes the results of the tests described in Table 6.

Table 11 – Results of performance and strength testing of braced trusses as an HLLS host structure

Performance testing: 1.2 m lanyard, E4 energy absorber, 100 kg wooden torso, Class A harness and free-fall distance of 1.2 m at mid-span of HLLS												
Test	Free-fall distance (m)	Fall of wooden torso (mm)	Lanyard + harness		Cable			Strain gauges of posts				Harness impact indicator stitches ripped
			Stretch lanyard only (mm)	Maximum arrest force (kN)	Maximum anchoring force		Zorbit deployment (no. of rips)	West post		East post		
					West (kN)	East (kN)		Compr. ($\mu\text{m/m}$)	Tension ($\mu\text{m/m}$)	Compr. ($\mu\text{m/m}$)	Tension ($\mu\text{m/m}$)	
1	1.2	3,190	559	3.41	4.64	4.52	0					0 out of 2
2	1.2	2,999	660	3.51	8.90	8.89	0					1 out of 2
3	1.2	2,958	622	3.37	8.52	8.36	0	-1,529	1,537	-1,473	1,503	0 out of 2
Av.	1.2	3,049	614	3.44	7.35	7.26	0					
Strength testing: 1.2 m, 5/8 in. three-strand nylon lanyard, no E4 energy absorber, 100 kg rigid mass and free-fall distance of 1.2 m at mid-span of HLLS												
Test	Free-fall distance (mm)	Fall of wooden torso (mm)	Lanyard + harness		Cable			Strain gauges of posts				Harness impact indicator stitches ripped
			Stretch lanyard only (mm)	Maximum arrest force (kN)	Maximum anchoring force		Zorbit deployment (no. of rips)	West post		East post		
					West (kN)	East (kN)		Compr. ($\mu\text{m/m}$)	Tension ($\mu\text{m/m}$)	Compr. ($\mu\text{m/m}$)	Tension ($\mu\text{m/m}$)	
4	1.2	2,402	70	5.35	12.57	11.99	10					N/A
5	1.2	2,306	89	5.34	12.53	11.80	9					N/A
6	1.2	2,402	57	5.52	13.83	11.84	9	-2,108	2,138	2,124		N/A
Av.	1.2	2,370	72	5.40	12.31	11.88	9					

During test 1, the diagonal and the top chord of the truss bracing at the roof ridge gave way under the thrust generated by the west post [Figure 52]. As a result, the maximum anchoring forces measured during the test were small, and the total fall distance of the torso observed during the test was higher than in later tests.



Figure 52 – Rupture of diagonal and top chord on east side, during test 1 of Table 6

After test 1, the structure was reinforced by adding several additional pieces of lumber at each end of the roof, i.e., those indicated in red in Figure 53.

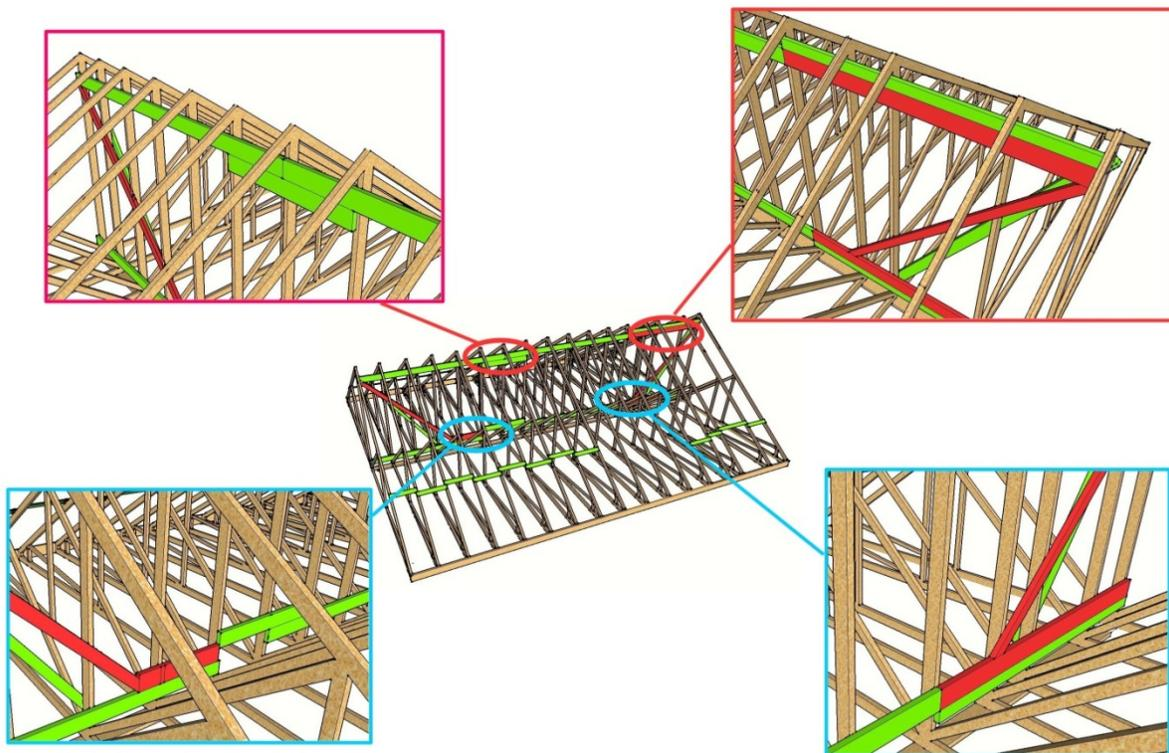

Figure 53 – Lumber (in red) added to framework after failure during test 1 of Table 6

In the subsequent tests 2 to 5, no damage was observed. During test 6, however, the host structure gave way again at the roof ridge on the east side [Figure 54].



Figure 54 – Rupture at roof ridge on east side, during test 6 of Table 6

3.5 Performance and Strength of Braced Trusses as Host Structure for CAN/CSA Z259.15-Certified Anchorage Connectors

The testing program set out in Table 7 was altered, as (1) three of the six anchorage connectors planned for the tests were not available and the time it would take to receive them exceeded the time the structure erected in the Polytechnique Montréal lab could be kept and (2) during test 4 with the anchorage connectors secured to plywood, the centre of the anchors lifted up more than what was observed in test 3. Test 1 was carried out according to the testing program, with the exception of the Protecta anchor, which was installed at the roof ridge [Figure 55 (a)], whereas the DBI and Ridge anchors were nailed in lower down on a roof truss [Figure 55 (b)] and [Figure 55 (c)]. These anchors were installed according to the manufacturer's instructions, using the recommended number of nails. The wooden torso was used for all the test 1 runs, while for the test 2 and test 3 runs, the steel mass was used [Figure 56] and no anchor was installed at the roof ridge. With tests 1 and 2 having gone successfully, instead of conducting test 3, it was decided to verify certain real work situations in which these anchors are not installed in accordance with the manufacturer's recommendations.

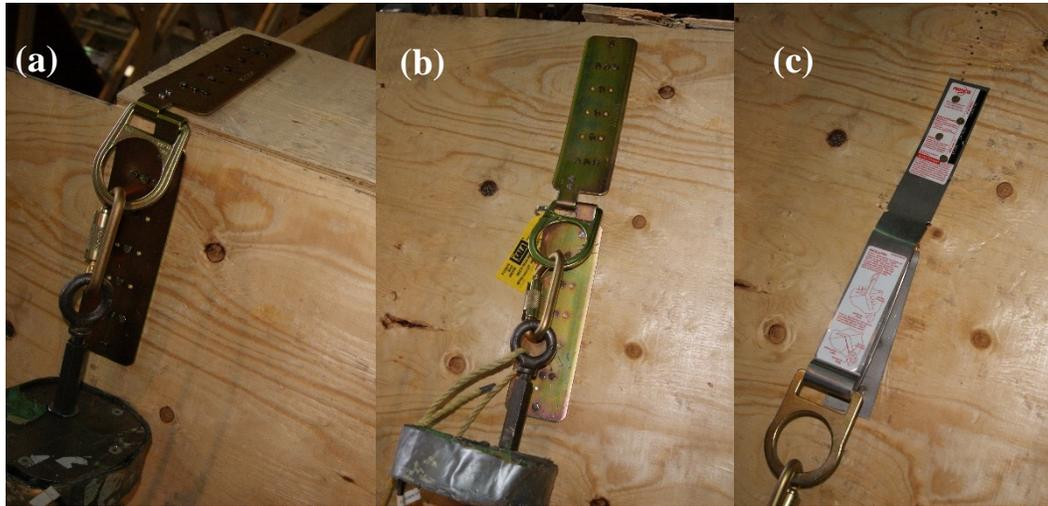

Figure 55 – Configuration of anchorage connectors for test 1: (a) Protecta, (b) DBI, (c) Ridge



Figure 56 – Test 2: Ridge anchorage connectors

During the test 3 runs, the number of nails used per anchor base leg was reduced to 3 instead of the 10 recommended by the manufacturers of the Protecta and DBI anchors, and to 2 instead of 4 for the Ridge anchors, as illustrated in Figure 57. These tests were conducted to verify certain non-recommended installation practices that nonetheless occur regularly on worksites, according to the contractor. In addition, the nails were not driven in all the way, which is another common practice in the residential housing industry, so that the nails can easily be pulled out with a hammer once the anchors are no longer needed.

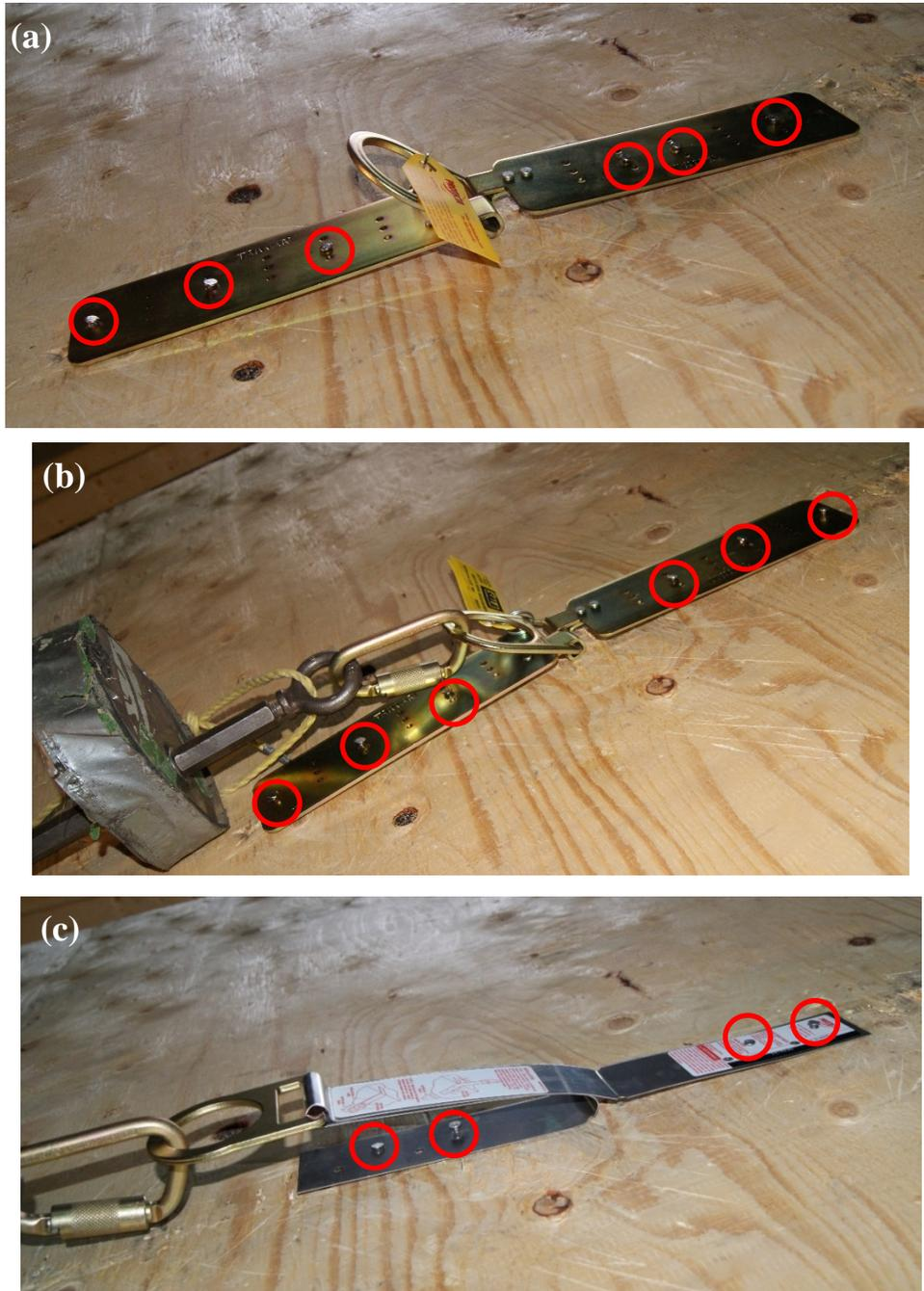

Figure 57 – Nailing of anchorage connectors for test 3: (a) Protecta, (b) DBI, (c) Ridge

Test 4 for the three anchor models was done with the wooden torso. Although the tests were relatively conclusive, the lifting up of the centre of the anchors prompted us to exercise caution, and a decision was made not to continue with the tests (5 and 6), nor with test 10, given that some anchors had been ripped out during test 7.

Table 12 sums up all the results of the Table 7 tests, while Table 13 summarizes all the observations made regarding the structure and the various anchors following the Table 7 tests.

Table 12 – Summary of results of Table 7 tests

Test	Fall of mass (m)			Lanyard + harness						Harness impact indicator stitches ripped		
	DBI	Protecta	Ridge	Lanyard stretch (mm)			Max. arrest force (kN)			DBI	Protecta	Ridge
				DBI	Protecta	Ridge	DBI	Protecta	Ridge			
1	1.2			610	603	610	3.84	3.08	3.40	2/2	2/2	2/2
2				667	648	679	4.28	3.84	2.95			
3				686	673	686	3.26	3.18	2.98			
Av.				654	641	658	3.80	3.37	3.11	2/2	2/2	2/2
4				711	673	660	3.73	3.76	3.37	2/2	2/2	2/2
5												
6												
Av.	1.2			711	673	660	3.73	3.76	3.37			
7	2.4			70	64	102	11.61	13.66	14.12			
8				102	102	102	17.48	13.68	14.36			
9				133	127	89	18.68	15.86	14.98			
10												
Av.				117	114	97	18.08	14.40	14.49			

Table 13 – Observations made after Table 7 tests

Test	Observations		
	DBI	Protecta	Ridge
1	No damage	No damage	No damage
2	No damage	No damage	No damage
3	Centre of anchor lifted up slightly	Centre of anchor lifted up 5 mm	Centre of anchor lifted up very slightly
4	Centre of anchor lifted up slightly	Centre of anchor lifted up slightly	Centre of anchor lifted up slightly
7	Anchor ripped out	Strap snap hook failed	Anchor nails stayed driven in
8	No apparent movement of anchor	Damage to eaves	One nail of anchor was partly pulled out and another was ripped out completely
9	No apparent movement of anchor	Damage to eaves, and centre of anchor lifted up 5 mm	One nail of anchor was ripped out

No apparent damage occurred to the anchorage connectors or the host structure during tests 1 and 2, and all the harness impact indicators deployed for the tests. During test 2 with the DBI anchor, the maximum arrest force of the lanyard with an E4 energy absorber was recorded at 4.28 kN, slightly above the limit of 4 kN. All the anchors lifted up slightly in test 3 conducted with a reduced number of nails [Figure 58]. The Ridge anchor is relatively more flexible than the other two, so the average maximum arrest force measured with it (3.37 kN) was, on average, lower than with the other two anchors (3.73 kN).

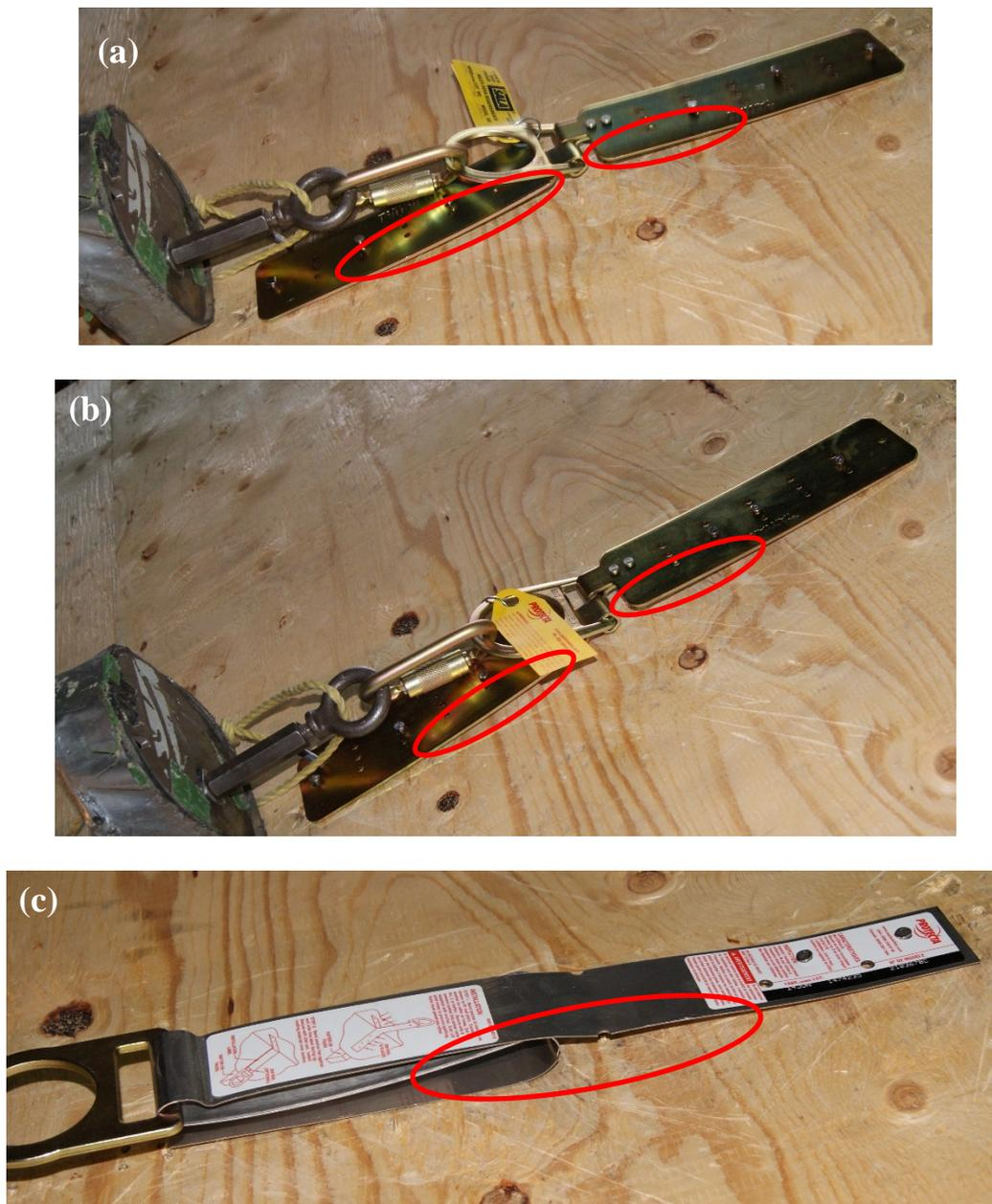

Figure 58 – Lifting of anchorage connectors in test 3: (a) DBI, (b) Protecta, (c) Ridge

For test 4, the anchorage connectors were fastened to the plywood only as a host structure, to simulate a potential case of improper installation on a jobsite. Despite that, no anchor gave way, and there was no evidence of nails being pulled out or loads being released, although the centre of the anchors did lift up slightly, to a greater degree than what was seen in test 3, as shown in Figure 59.

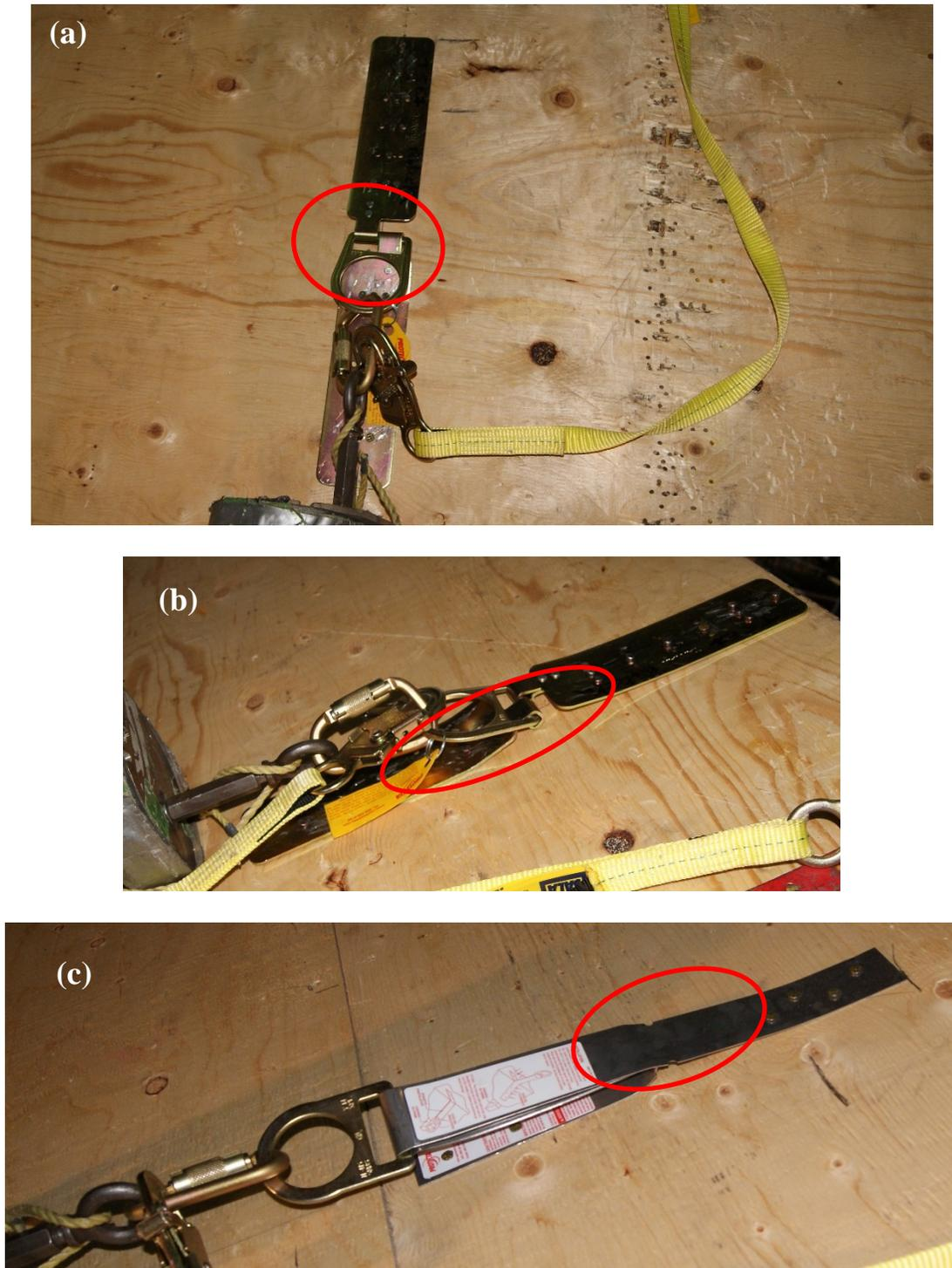

Figure 59 – Lifting of anchorage connectors in test 4: (a) DBI, (b) Protecta, (c) Ridge

Tests 7, 8 and 9 were conducted to assess the strength of the anchorage connectors and the host structure by generating maximum forces in the fall arrest system to simulate failure. To do so, the lanyard with an energy absorber was replaced with a lanyard having a 1 in. wide nylon strap without an energy absorber, and the tests were carried out using a free-fall distance of 2.4 m.

Tests 7, 8 and 9 were done first with the Protecta anchors. In test 7 with this anchor, the snap hook on the 1 in. wide nylon strap broke, as shown in Figure 60 (a). The centre of the anchor lifted up approximately 5 mm, and half of the nails in the upper leg were partially pulled out [Figure 60 (b)]. The load was released, and the steel mass hit the floor.

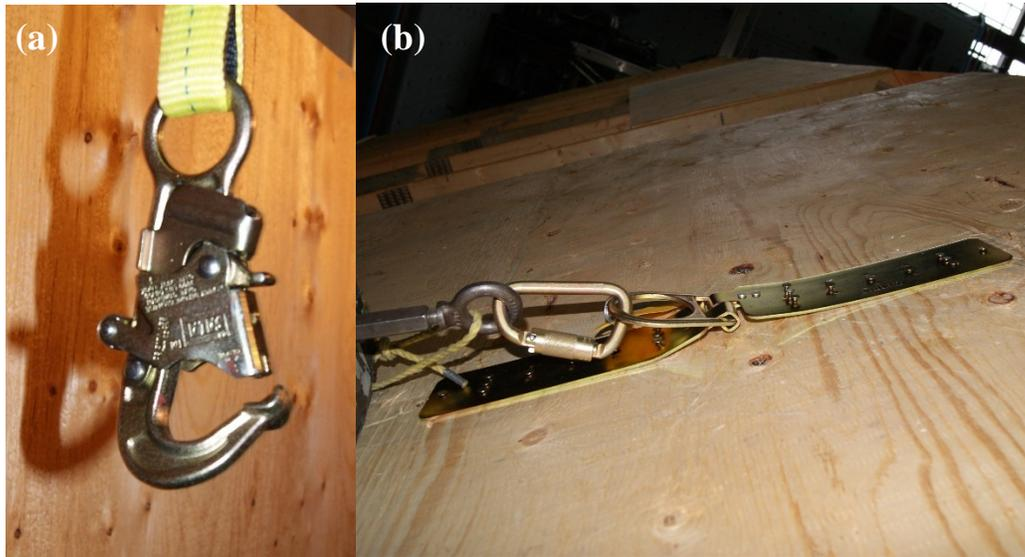

Figure 60 – Test 7 with Protecta anchorage connector: (a) failure of lanyard snap hook; (b) lifting and partial pulling out of nails of upper leg of anchor

During test 8 with the Protecta anchor, the roof eave gave way [Figure 61].



Figure 61 – Failure of roof eave in test 8 with Protecta anchor

Figure 62 shows lifting up and partial pulling out of the nails of the Protecta anchor in test 8. The amount of lift is approximately the same as that noted in test 7. In addition, the attachment to the snap hook of the nylon strap lanyard was damaged [Figure 63].



Figure 62 – Test 8 with Protecta anchorage connector: lifting and partial pulling out of nails of upper leg of anchor



Figure 63 – Test 8 with Protecta anchorage connector: partial damage of attachment to snap hook of nylon strap lanyard

Figure 64 shows how the upper leg of the connector was lifted up and its nails were partially pulled out during test 9 of the Protecta anchor. Figure 65 shows the damage to the roof eave caused by the nylon strap lanyard.



Figure 64 – Test 9 with Protecta anchorage connector: lifting and partial pulling out of nails of upper leg of anchorage connector



Figure 65 – Test 9 with Protecta anchorage connector: damage to roof eave

When the first test with the DBI anchor was conducted, i.e., test 7, the anchor was ripped out completely [Figure 66] and the load was released, with the steel mass ending up on the ground [Figure 67].



Figure 66 – Test 7 with DBI anchorage connector: state of anchor after test



Figure 67 – Test 7 with DBI anchorage connector: steel mass fell to the ground

The failure of this anchor and the degree of damage to the plywood and roof truss may have been due to the successive nailing required for the previous tests. As a result, a 2 in. x 6 in. board was added to

ensure the same anchorage conditions for the subsequent tests as for the earlier ones. The new 2 x 6 had the effect of doubling the amount of the roof truss in contact with the plywood [Figure 68].

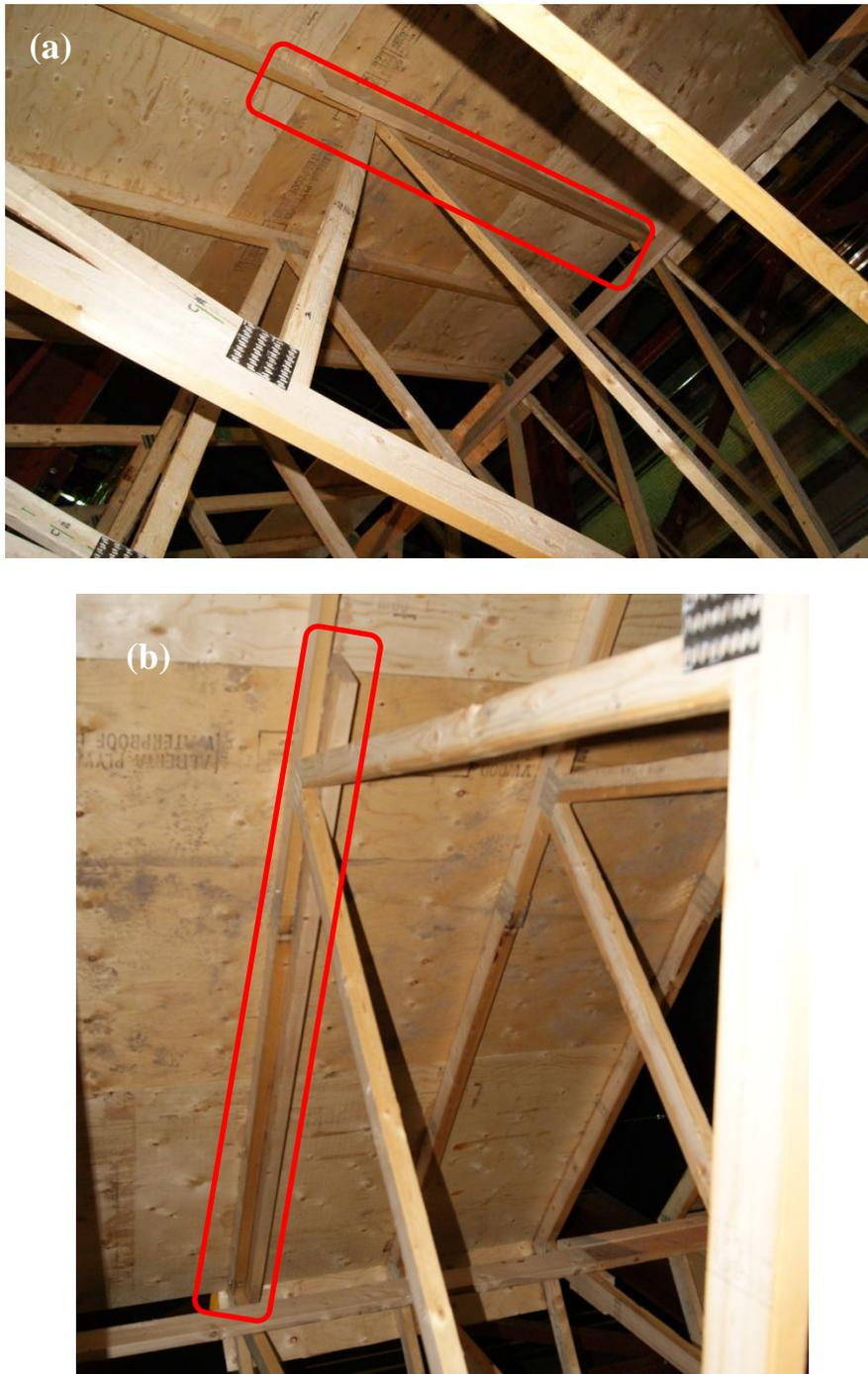

Figure 68 – 2 in. x 6 in. lumber added to double roof truss after an anchor was ripped out: (a) east side of truss; (b) west side of truss

There was no further damage to the roof eave during tests 8 and 9 with the DBI anchor. The lifting up and pulling out of the nails [Figure 69] were comparable to what was seen in the tests with the Protecta anchors.



Figure 69 – DBI anchorage connector: (a) lifting of anchor and pulling out of nails during test 8 of Table 7; (b) lifting of anchor and pulling out of nails during test 9

Figure 70 shows the state of the Ridge anchorage connector after test 7. It can be seen that the point of attachment of the ring has moved. The fold line of the lower leg has also moved as far as the first nail. No nails were pulled out during the test.



Figure 70 – Test 7 with Ridge anchorage connector: state of anchor after test

Figure 71 and Figure 72 show the state of the Ridge anchorage connector after tests 8 and 9 respectively. The top nail of the lower leg of the anchor was pulled all the way out in both tests. The next nail was pulled out slightly. Similarly, the fold line moved as in test 7, but this time as far as the second nail.



Figure 71 – Test 8 with Ridge anchorage connector: state of anchor after test



Figure 72 – Test 9 with Ridge anchorage connector: state of anchor after test

4. DISCUSSION

This section discusses the results of the research work in relation to the study objectives, which were to:

- 1) Evaluate an HLLS designed by a construction contractor from the standpoints of reliability, efficiency and user-friendliness with a view to improving it;
- 2) Make the necessary changes to the HLLS;
- 3) Test the strength of trusses braced according to common jobsite practices as a host structure for a worker's lanyard in accordance with CAN/CSA Z259;
- 4) Test the strength of trusses braced according to common jobsite practices as a host structure for an HLLS in accordance with CAN/CSA Z259;
- 5) Test the strength of trusses braced according to common jobsite practices as a host structure for six CAN/CSA Z259.15-certified anchorage connectors.

4.1 HLLS Evaluation

By its design, the HLLS is:

- Reliable, as it is primarily made of metal structural members that are easy to inspect visually and with which workers are familiar. These members are not affected by UV rays;
- Efficient because its design is governed by industry standards respecting strength of materials and dynamic drop testing according to the requirements of CAN/CSA Z259 on fall protection;
- User-friendly because its weight has been reduced considerably, making it easier to handle. In addition, it makes it easier for workers to move around, provides continuity for lanyard point of attachment and requires little intervention to activate worker protection, thus avoiding interference in work activities. By attaching themselves just once, workers can perform an uninterrupted sequence of actions while remaining safe throughout the duration of their tasks.

4.2 HLLS Improvement

The old post was made of three 2 in. x 6 in. x ¼ in. HSSs welded together to form an HSS equivalent to one 6 in. x 6 in. x ¼ in. HSS. The new post is now made of one 5 in. x 5 in. x ¼ in. HSS [Figure 4], which makes it considerably lighter. Riopel⁶ proposed a 6 in. x 6 in. x ¼ in. HSS. Verification by structural analysis also showed that a 102 mm x 102 mm x 9.5 mm (4 in. x 4 in. x 3/8 in) aluminum HSS weighing 43 kg would also be suitable and would be easier to handle than the 127 mm x 127 mm x 6.4 mm (5 in. x 5 in. x ¼ in.) HSS weighing 39 kg. But with the 102 mm x 102 mm x 9.5 mm (4 in. x 4 in. x 3/8 in.) HSS being heavier, the 127 mm x 127 mm x 6.4 mm HSS offered an advantage with regard to weight and so was chosen for the HLLS post.

The results of the Table 8 tests showed that the 127 mm x 127 mm x 6.4 mm HSS post chosen in the structural analysis successfully passed all the Table 3 dynamic drop tests of performance and strength as a lanyard anchorage. Similarly, the results of the Table 9 tests showed that these same posts also successfully passed all the Table 4 dynamic drop tests of performance and strength as an HLLS

6. M. Riopel, 2012, *Conception d'un dispositif de prévention des chutes*, internship report, Polytechnique Montréal.

anchorage. As a result, no change was made in the HLLS structural members, and the 127 mm x 127 mm x 6.4 mm HSS was selected for the HLLS post.

4.3 Trusses Braced According to Common Jobsite Practices as a Host Structure of a Post for Anchoring a Worker's Lanyard

The results of the Table 10 tests showed that the trusses braced [Figure 53] in accordance with common jobsite practices successfully passed all the Table 5 dynamic drop tests for performance and strength as a host structure for a worker's lanyard with a 127 mm x 127 mm x 6.4 mm HSS serving as the anchorage. In the first strength test (test 4) of Table 5, the bracing of the host structure suffered slight damage to the roof ridge beam [Figure 50]. It was repaired before tests 5 and 6 were conducted.

4.4 Trusses Braced According to Common Jobsite Practices as an HLLS Host Structure

The results of the Table 11 tests showed that the trusses braced [Figure 53] in accordance with common jobsite practices were able to arrest the fall of the wooden torso. However, damage was noted in test 1 of Table 6 and the structure had to be strengthened before further testing could proceed. In that test, the diagonal and the top chord of the truss bracing at the roof ridge gave way under the thrust generated by the west post [Figure 54]. The structure was subsequently reinforced by installing some additional boards to each end of the roof, i.e., those indicated in red in Figure 53.

The truss structure with the reinforced bracing passed all the dynamic drop tests for performance and strength as an HLLS host structure, with 127 mm x 127 mm x 6.4 mm HSSs as the HLLS post. In light of these results, we felt it was essential, as a minimum, to reinforce the bracing of the framework erected for the study [Figure 53], while at the same time taking care to establish continuity in the bracing installed on the vertical members.

4.5 Trusses Braced According to Common Jobsite Practices as a Host Structure for CAN/CSA Z259.15-Certified Anchorage Connectors

4.5.1 Dynamic Performance Testing

Tests were conducted on DBI, Protecta and Ridge anchorage connectors only, as the other anchor models were not available. The results obtained with the DBI, Protecta and Ridge anchors can be extrapolated to the other, non-tested anchors, since according to their technical specifications, they are similar in design and made by the same company.

The results of the Table 12 tests showed that the reinforced trusses braced [Figure 53] in accordance with common jobsite practices successfully passed all the dynamic drop tests for performance as a host structure for CSA Z259.15-certified DBI, Protecta and Ridge anchors installed according to the manufacturer's instructions, with the recommended number of nails driven into a rafter. In tests 1 and 2, no apparent damage to the anchors or host structure was noted.

In the runs of test 3, with the anchors fastened to the truss rafters using a reduced number of nails not completely driven in (Protecta and DBI with 3 nails per leg instead of 10, and Ridge with 2 nails per leg instead of 4), slight lift was observed at the centre of the three anchors. Even though no anchor gave

way, and no load was released, this practice should be prohibited on jobsites; anchors must be installed according to the manufacturer's instructions.

In the runs of test 4, with the anchors fastened only to the plywood as a host structure, no anchors gave way, nor were there any signs of nails being ripped out or of loads being released. There was evidence of slight lifting of the centre of the anchors, however. Although test 4 was relatively conclusive, it prompted us to recommend caution and to prohibit the use of plywood alone as a surface to which CAN/CSA Z259.15-certified anchorage connectors may be fastened.

4.5.2 Dynamic Strength Testing (Failure)

Tests 7, 8 and 9 were done with a 1 in. wide nylon strap lanyard, without an energy absorber, with a free-fall distance of 2.4 m in accordance with clause 8.2.3.3 – *Initial dynamic strength test procedure* of standard CAN/CSA Z259.15, whereas usual dynamic strength tests are conducted with a 5/8 in. three-strand nylon lanyard, without an energy absorber, with a free-fall distance of 1.2 m. Tests 7, 8 and 9 are very stringent anchorage connector certification tests under standard CAN/CSA Z259.15 and are not suitable for assessing the strength of host structures. The average maximum arrest forces measured in the lanyards during these tests were 18 kN for the DBI anchor, 14.4 kN for the Protecta anchor and 14.5 kN for the Ridge anchor. These maximum arrest forces will never be reached when an E4 energy absorber is in the lanyard.

Here are the main observations noted during the tests:

Test 7

- The DBI anchor was ripped out completely, and the test mass ended up on the ground. After this anchor failed, a decision was made to add a 2 in. x 6 in. piece of lumber to provide a new anchorage for the subsequent tests, as it was highly possible that the previous tests had damaged the plywood on the roof.
- With the Protecta anchor, the snap hook of the 1 in. wide nylon test strap broke, the centre of the anchor lifted up 5 mm, half of the nails in the upper leg were partially pulled out and the steel mass ended up on the ground.
- With the Ridge anchor, the nails stayed driven in.

Test 8

- With the DBI anchor, no additional damage occurred to the eaves, and anchor lift and nail pull-out were comparable with the results for the Protecta anchors.
- The roof eave gave way with the Protecta anchor. Anchor lift and partial nail pull-out occurred, and the attachment of the lanyard snap hook was damaged.
- The top nail of the lower leg of the Ridge anchor was pulled all the way out, and the next nail was pulled out slightly.

Test 9

- With the DBI anchor, no additional damage occurred to the eaves, and anchor lift and nail pull-out were comparable with the results for the Protecta anchors.
- With the Protecta anchor, lift was noted, the nails in the upper leg were pulled out partially and the eave was damaged by the nylon strap.

- The top nail of the lower leg of the Ridge anchor was pulled all the way out, while the next nail was pulled out slightly.

Tests 7, 8 and 9 simulated the failure of the reinforced braced trusses as a host structure for CAN/CSA Z259.15-certified anchorage connectors. The results of the performance testing showed, however, that the reinforced braced trusses of Figure 53 can be used as a host structure for CAN/CSA Z259.15-certified anchorage connectors that are installed in accordance with the manufacturer’s instructions.

4.6 Scope and Limitations of Study

The study demonstrated HLLS functionality on a house framework in the process of construction. For the system to be effective, however, the framework must be braced properly and, at a minimum, must follow the recommendations for “reinforced bracing” presented in this report. In addition, the HLLS itself must be installed on the framework properly. A system presentation and installation guide is being prepared in partnership with ASP Construction and will be available on the IRSST website.

The dynamic drop testing conducted on the anchorage connectors showed the performance and strength of this type of anchor when they are installed according to the manufacturer’s recommendations. As the number of test configurations was relatively limited, further studies may be necessary to confirm the strength of these anchors in a range of different situations.

5. CONCLUSION AND RECOMMENDATION

The work carried out in this study made it possible to evaluate and optimize an HLLS made of two 127 mm x 127 mm x 6.4 mm aluminum HSSs and a DBI Sala Sayflite standard horizontal lifeline. Structural analysis in accordance with classical strength-of-materials methods, design code CAN S157 – *Strength Design in Aluminum*, and testing in accordance with the requirements of the CAN/CSA Z259 standards on fall protection were used to assess the performance and strength of (1) each structural member of the HLLS and (2) the reinforced trusses braced [Figure 53] following common jobsite practices as host structures for a worker’s lanyard, the HLLS and standard CSA Z259.15-certified anchorage connectors.

The results of the performance and strength testing showed that the horizontal lifeline system and the trusses [Figure 53] braced and reinforced following common jobsite practices successfully passed all of the performance and strength drop tests conducted as part of the testing program. The HLLS can therefore be used as a safe fall protection system, and trusses braced and reinforced in accordance with common jobsite practices can be used as a host structure for a worker’s lanyard, the HLLS and CAN/CSA Z259.15-certified anchorage connectors installed according to the manufacturer’s instructions.

In addition, the contractor’s HLLS was improved by reducing the weight of the posts considerably (by around 60%), which helped reduce the total weight of the HLLS by approximately 30%. The HLLS gives workers greater mobility and protects them the entire time they are working, while also enhancing productivity; it provides appropriate protection against falls from heights for residential roofing workers. It should be noted, however, that a mechanical means of lifting is required to install and remove the HLLS. Moreover, it is not suitable for existing roofs, as properly securing the posts to the roof can be difficult.

It is to be hoped that the improved version of the HLLS, verified and validated by standardized CAN/CSA Z259 testing, will facilitate its use on construction sites. To that end, a knowledge-transfer initiative is in preparation with a view to producing plans and reference material for making an HLLS, with or without turnbuckles, as well as a user guide, to promote its use on roofing worksites.

BIBLIOGRAPHY

- Alaurent, R., J. Arteau, P.C. Wing, J-F. Corbeil, L. Desbois, D. Fortin and A. Lan. (1992). *Conception de Câbles de Secours Horizontaux* (1992). 4. Course notes, École Polytechnique de Montréal.
- AQFSB. (2009a). Association québécoise des fabricants de structures de bois. *Guide d'installation et de contreventement des fermes de toit de longue portée*. Victoriaville, Quebec.
- AQFSB. (2009b). Association québécoise des fabricants de structures de bois. *Liens continus, montage et contreventement des fermes de toit*. Victoriaville, Quebec.
- Arteau, J., Lan, A. (1991). *Protection contre les chutes de hauteur – Conception de câbles de secours horizontaux*. Études et recherches / Guide technique T-18. Montreal, IRSST, 1991, 56 pages.
- CAN/CSA Z259.10. (2012). Canadian Standards Association. *Full Body Harnesses*. Mississauga, Ontario.
- CAN/CSA Z259.11. (2010). Canadian Standards Association. *Energy Absorbers and Lanyards*. Mississauga, Ontario.
- CAN/CSA Z259.15. (2012). Canadian Standards Association. *Anchorage Connectors*. Mississauga, Ontario.
- CAN/CSA-S157. (2000). Canadian Standards Association. *Strength Design in Aluminum*. Rexdale, Ontario, CSA, 2000.
- CAN/CSA-S16-09. (2014). Canadian Institute of Steel Construction. *Limit States Design of Steel Structures*. Willowdale, Ontario CSIC.
- CECOBOIS. (2011). Centre d'expertise sur la construction commerciale en bois. *Guide technique sur les fermes de toits légères pour la construction commerciale*. Quebec City, Quebec.
- CMHC. (2015). *Canadian Wood-Frame House Construction* (ISBN 0-660-19535-6). Canada Mortgage and Housing Corporation. Retrieved July 2015 from <https://www.cmhc-schl.gc.ca/odpub/pdf/61010.pdf?fr=1414012864483>.
- Duguay, P., Massicotte, P. (2007). *Décès indemnisés à la suite d'une lésion professionnelle: Comparaison entre le Québec, l'Ontario et la Colombie-Britannique, 1997–2003*. Études et recherche. Report, Montreal, IRSST.
- Dupont, L. (2010). “Les Câbles de Secours Horizontaux: Une ‘Ligne De Vie’ à l’horizontale.” *Prévention au travail*, Vol. Printemps 2010, (2010).
- Lan, A., Arteau, J., Sirard, C. (2004). “Method for validating a multi-component safety system.” *Safety Science*, Volume 46, Issue 6, 2004, p. 493–517.
- Lan, A., Daigle, R. (2008). *Résistance du point d'ancrage d'un système d'arrêt de chute et de positionnement pour les poseurs d'acier d'armature*. Études et recherches. Report R-550, Montreal, IRSST, 2008, 40 pages.
- Lan, A., Daigle, R. (2011). *Système d'ancrage de garde-corps sur toits plats pour couvreurs*. Études et recherches. Report R-678, Montreal, IRSST, 74 pages.
- NBCC. (2010). National Research Council of Canada. *National Building Code of Canada*. Ottawa, Ontario.

OSHA. (1998). *Part 1926 Subpart M CFR 1926.500 – Fall Protection for the Construction Industry*. U.S. Department of Labor, Washington, DC.

ROHS. (2013). *Regulation respecting Occupational Health and Safety*. Éditeur officiel du Québec. Quebec City, Quebec. 2013.

S-2.1, r. 4. (2013). *Safety Code for the Construction Industry*. Les Publications du Québec, Government of Quebec. Quebec City, Quebec.

APPENDIX A – HLLS EVALUATION

A.1 Structural Analysis

The purpose of this structural analysis is to (1) show that an energy absorber needs to be included in the HLLS to limit the forces acting on the host structure and (2) optimize the HLLS. For an HLLS similar to the one developed by the residential building contractor, made of 8 mm IWRC wire rope, with an initial tension of 891.82 N (200 lb), with a 54 in. fixed end, a span from 1.83 m to 10 m, and an E4 energy absorber compliant with standard CAN/CSA Z259.11 that limits the maximum arrest force to 4 kN, the maximum anchoring force calculated with the IRSST nomograms (Arteau and Lan, 1991) is approximately 18.75 kN when arresting an accidental fall.

A.1.1 Verification of HLLS

Maximum anchoring load $T = 18.75 \text{ kN}$
 Fixed end $H = 54 \text{ in.} = 1.37 \text{ m}$
 Cable span = 1.83 m (6 ft.)

Figure A.1 shows a free-body diagram of the forces acting on the HLLS. Figure A.2 shows the loads on the HLLS structural members.

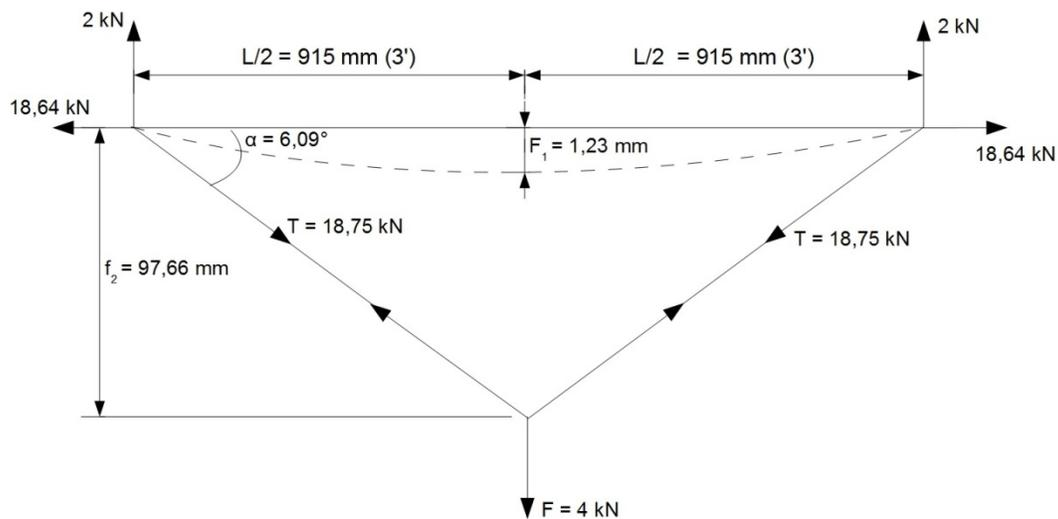

Figure A.1 – Forces acting on anchorages

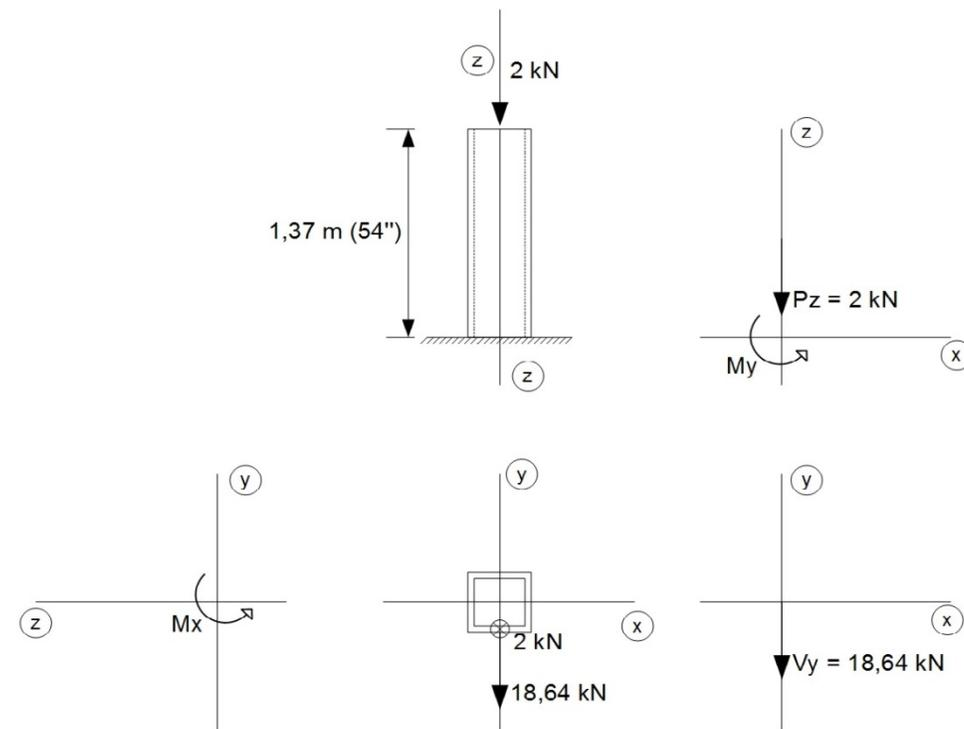

Figure A.2 – Loads on structural members

A.1.2 Forces Acting on Cable Anchorage

From Figure A.1:

Force in cable $T = 18.75$ kN

Vertical force at cable anchorage $= T \sin \alpha = 18.75 \sin 6.09 = 1.99$, i.e., 2 kN

Horizontal force at cable anchorage $T_2 = T \cos \alpha = 18.75 \cos 6.09 = 18.64$ kN

Fixed end $H = 1.37$ m (54 in.)

With the axes x , y and z indicated as in Figure A.2, these forces generate the following loads at the base of the post, the section most subject to external forces:

$$P_z = \text{axial force} = 2 \text{ kN}$$

$$V_y = \text{shear} = 18.64 \text{ kN}$$

$$M_x = \text{bending moment} = 18.64 \times 1.37 + 2 \times 0.051/2 = 25.59 \text{ kN}\cdot\text{m}$$

$$M_y = \text{bending moment} = 0$$

A.1.3 Maximum Factored Loads

According to section 7.2.1 of the *Handbook of Steel Construction* (HSC), the member shall be designed such that its factored resistance is greater than or equal to the effect of factored loads. This can be expressed by the following equation:

$$\phi R \geq \Sigma \alpha_i S_i$$

where:

ϕR : factored resistance, calculated according to standard S-16-09;

$\Sigma \alpha_i S_i$: effect of factored loads calculated in accordance with clause 4.1.3.2 of the National Building Code of Canada (NBCC);

α_i : load factors, according to NBCC;

ϕ : resistance factors, according to NBCC.

Clause 4.1.2.1 of the NBCC lists all the loads that can act on a member/structure. Only dead load D and live load L (maximum anchoring force) act on the HLLS. Table 4.1.3.2.A gives the following combinations of dead load D and live load L (maximum anchoring force) acting on the HLLS:

1. 1.4D
2. (1.25 or 0.9D) + 1.5L

If the self-weight of the HLLS in relation to the maximum anchoring force is disregarded, the most critical combination of loads is 1.5L.

D: dead load

L: live load

The factored loads acting on the HLLS are:

$$P_{fz} = 1.5L = 1.5 \times 2 = 3 \text{ kN}$$

$$V_{fy} = 1.5V_y = 1.5 \times 18.64 = 27.96 \text{ kN}$$

$$M_{fx} = 1.5M_y = 1.5 \times 25.59 = 38.38 \text{ kN}\cdot\text{m}$$

$$M_{fy} = 0$$

For the 1.37 m post, the slenderness ratio kL is taken as being equal to 1,500 mm (1.5 m). The bending and shear of the steel posts, designed in accordance with standard CAN/CSA-S-16.1 – *Design of Steel Structures*, and of the HLLS aluminum posts designed in accordance with standard CAN3-S157-M83 – *Strength Design in Aluminum*, need to be assessed.

A.1.4 Verification of Bending

According to section 13.8.3 of the HSC, an HLLS post, i.e., a member other than an I section that resists both bending and axial compression, must be designed so that:

$$\frac{C_f}{C_r} + \frac{U_{1x}M_{fx}}{M_{rx}} + \frac{U_{1y}M_{fy}}{M_{ry}} \leq 1$$

where:

C_f = factored compressive load

C_r = factored compressive resistance

U_{1x} = 1 for a member in an unbraced frame

U_{1y} = 1 for a member in an unbraced frame

M_{fx} = factored bending moment, x axis

M_{fy} = factored bending moment, y axis

M_{rx} = factored moment of resistance, x axis
 M_{ry} = factored moment of resistance, y axis

A.1.5 Verification of Shear

According to section 13.4.1.3 of the HSC, the factored shear resistance of a class 1 and 2 tubular section, where local buckling of the walls is prevented, is given by:

$$V_r = 0.66\phi(A/2)F_y$$

where:

V_r = factored shear resistance

$\phi = 0.9$

A = area of tubular section

F_y = elastic limit

A.1.6 Verification of Residential Building Contractor's HLLS

From section A.1.2:

$$P_{fz} = 1.5L = 1.5 \times 2 = 3 \text{ kN}$$

$$V_{fy} = 1.5V_y = 1.5 \times 18.64 = 27.96 \text{ kN}$$

$$M_{fx} = 1.5M_y = 1.5 \times 25.59 = 38.38 \text{ kN}\cdot\text{m}$$

A quick check of the HSC and CAN3-S157 shows that:

- 1) The contractor's HLLS post, made of three 2 in. x 6 in. HSSs, is oversized;
- 2) A 114 mm x 114 mm x 8 mm (4½ in. x 4½ in. x 5/16 in.) steel HSS with $M_r = 39.7 \text{ kN}\cdot\text{m}$ or a 127 mm x 127 mm x 9.5 mm (5 in. x 5 in. x 3/8 in.) aluminum HSS with $M_r = 39.50 \text{ kN}\cdot\text{m}$ is suitable to withstand these loads.

But these sections are heavy, which is not consistent with the study objective of optimizing the HLLS. As a result, to limit the maximum anchoring force in the HLLS, an energy absorber limiting the maximum anchoring force to 11.36 kN (2,500 lb) was used. This absorber was already included in the original HLLS.

A.2 Optimization of HLLS – Use of an Energy Absorber in HLL

With the 11.36 kN energy absorber integrated into the horizontal lifeline, three sections seem promising, namely:

1. 89 mm x 89 mm x 9.5 mm (3½ in. x 3½ in. x 3/8 in.) steel HSS
2. 102 mm x 102 mm x 9.5 mm (4 in. x 4 in. x 3/8 in.) aluminum HSS
3. 127 mm x 127 mm x 6.4 mm (5 in. x 5 in. x ¼ in.) aluminum HSS

A.2.1 Verification of an 89 mm x 89 mm x 9.5 mm (3½ in. x 3½ in. x 3/8 in.) Steel HSS with Use of an 11.36 kN (2,500 lb) Energy Absorber

From the *Handbook of Steel Construction* (HSC), for an 89 mm x 89 mm x 9.5 mm HSS:

$$\begin{aligned} M_r &= 25.4 \text{ kN}\cdot\text{m} \\ C_r &= 725.50 \text{ kN (by interpolation for } kL = 1,500 \text{ mm)} \\ T &= 11.36 \text{ kN (2,500 lb)} \end{aligned}$$

with $T = 11.36 \text{ kN}$, the factored loads are:

$$\begin{aligned} P_{fz} &= 1.5 \times 2 = 3 \text{ kN} \\ V_{fy} &= 1.5 \times 11.36 = 17.04 \text{ kN} \\ M_{fx} &= 1.5 \times 15.65 = 23.48 \text{ kN}\cdot\text{m} \\ M_{fy} &= 0 \end{aligned}$$

A.2.2 Verification of Bending

$$\frac{C_f}{C_r} + \frac{U_{1x}M_{fx}}{M_{rx}} + \frac{U_{1y}M_{fy}}{M_{ry}} \leq 1$$

$$\frac{3}{725.5} + \frac{1 \times 23.48}{25.4} + \frac{1 \times 0}{25.4} \leq 1$$

$$0.414 + 0.92 + 0 = 0.93 \leq 1 \text{ OK}$$

A.2.3 Verification of Shear

$$\begin{aligned} V_{fy} &= 17.04 \text{ kN} \\ V_r &= 0.66\phi(A/2)F_y \\ V_r &= 0.66 \times 0.9 \times (2,790/2)350 = 290,020.5 \text{ N} = 290 \text{ kN} \\ V_r &= 290 \text{ kN} \geq V_{fy} = 17.04 \text{ kN} \qquad \text{OK} \end{aligned}$$

As bending governs, the 89 mm x 89 mm x 9.5 mm steel HSS is adequate for the use of an 11.36 kN (2,500 lb) energy absorber in the HLLS.

A.2.4 Verification of Minimum Clearance

When a fall is arrested, the energy absorber in the HLLS will deploy, so it is important to check the minimum clearance below the HLLS against the energy absorber manufacturer’s data to make sure the worker will not hit the ground.

The clearance (D) required for a worker held by an HLLS is calculated as follows:

$$D = f_2 + L_l + d_a + h_t + d_s + e_h \tag{1}$$

where L_l is the length of the lanyard (1.2 m or 1.8 m), d_a the deployment distance of the energy absorber (max 1.2 m for a Class E4 absorber, 1.8 m for a Class E6), h_t the final height of the D ring in relation to the worker's feet (in m), d_s the clearance margin or safety distance (1 m for an HLLS, as defined in CAN/CSA Z259.13) and e_h the harness stretch (approximately 0.2 m).

This calculation gives a conservative estimate, as the average deployment of the energy absorber (d_a) can be calculated using the following equation (principle of the conservation of energy):

$$d_a = \frac{Wh}{F_m - W} \quad (2)$$

where h is the free-fall distance (in m), W the weight of the worker in N (including his/her equipment), and F_m the average deployment force of the absorber (between 2.5 kN and 2.8 kN for a Class E4 absorber as observed during dynamic drop testing, or $0.8 \times 4 = 3.2$ kN in accordance with CAN/CSA Z259.16, approximately 4.8 kN for a Class E6 absorber).

In other words, for a free-fall distance of 1.2 m and a worker weighing 100 kg:

$$d_a = \frac{100 \times 9.81 \times 1.2}{2600 - 100 \times 9.81} = 0.727m \quad (3)$$

considering a tear force of 2.6 kN, as observed during the laboratory testing. If a tear force of 3.2 kN was considered, the deployment of the absorber would be 52 cm.

A.3 Verification of a 102 mm x 102 mm x 9.5 mm (4 in. x 4 in. x 3/8 in.) Aluminum HSS with Use of an 11.36 kN (2,500 lb) Energy Absorber

For 6061 – T6 aluminum, Table 2.2 of CAN3-S157-M83, $F_y = 240$ MPa.

From the HSC, for a 102 mm x 102 mm x 9.5 mm steel HSS:

$$M_r = 34.7 \text{ kN}\cdot\text{m}$$

$$C_r = 904 \text{ kN (by interpolation for } kL = 1,500 \text{ mm)}$$

For a 102 mm x 102 mm x 9.5 mm aluminium HSS:

$$M_r = (34.7 \times 240)/350 = 23.79 \text{ kN}\cdot\text{m (prorated } F_y \text{ aluminum}/F_y \text{ steel)}$$

$$C_r = (904 \times 240)/350 = 619.9 \text{ kN (by interpolation for } kL = 1,500 \text{ mm)}$$

With an 11.36 kN (2,500 lb) energy absorber in the HLLS, the factored loads at the base of the post, i.e., the section most subject to external forces, are (section A.1.3):

$$P_{fz} = 1.5 \times 2 = 3 \text{ kN}$$

$$V_{fy} = 1.5 \times 11.36 = 17.04 \text{ kN}$$

$$M_{fx} = 1.5 \times 15.65 = 23.48 \text{ kN}\cdot\text{m}$$

$$M_{fy} = 0$$

A.3.1 Verification of Bending

$$\frac{C_f}{C_r} + \frac{U_{1x}M_{fx}}{M_{rx}} + \frac{U_{1y}M_{fy}}{M_{ry}} \leq 1$$

$$\frac{3}{619.9} + \frac{1 \times 23.48}{23.79} + \frac{1 \times 0}{23.79} \leq 1$$

$$0.00484 + 0.98697 + 0 = 0.99 \leq 1 \quad \text{OK}$$

A.3.2 Verification of Shear

$$V_{fy} = 17.04 \text{ kN}$$

$$V_r = 0.66\phi(A/2)F_y$$

$$V_r = 0.66 \times 0.9 \times (3,000/2) \times 240 = 213,840 \text{ N} = 214 \text{ kN}$$

$$V_r = 213.84 \text{ kN} \geq V_{fy} = 17.04 \text{ kN} \quad \text{OK}$$

As bending governs, the 102 mm x 102 mm x 9.5 mm aluminum HSS is adequate for the use of an 11.36 kN (2,500 lb) energy absorber in the HLLS.

A.3.3 Verification of Minimum Clearance

See section A.2.4.

A.4 Verification of a 127 mm x 127 mm x 6.4 mm (5 in. x 5 in. x ¼ in.) Aluminum HSS with Use of an 11.36 kN (2,500 lb) Energy Absorber

For 6061 – T6 aluminum, Table 2.2 of CAN3-S157-M83, $F_y = 240 \text{ MPa}$.

From the HSC, for a 127 mm x 127 mm x 6.4 mm steel HSS:

$$M_r = 37.6 \text{ kN}\cdot\text{m}$$

$$C_r = 775.08 \text{ kN (by interpolation for } kL = 1,500 \text{ mm)}$$

For a 127 mm x 127 mm x 9.5 mm aluminum HSS:

$$M_r = (37.6 \times 240)/350 = 25.78 \text{ kN}\cdot\text{m (prorated } F_y \text{ aluminum}/F_y \text{ steel)}$$

$$C_r = (775.08 \times 240)/350 = 535.5 \text{ kN}$$

With an 11.36 kN (2,500 lb) energy absorber in the HLLS, the factored loads at the base of the post, i.e., the section most subject to external forces, are (section A.1.3):

$$P_{fz} = 1.5 \times 2 = 3 \text{ kN}$$

$$V_{fy} = 1.5 \times 11.36 = 17.04 \text{ kN}$$

$$M_{fx} = 1.5 \times 15.65 = 23.48 \text{ kN}\cdot\text{m}$$

$$M_{fy} = 0$$

A.4.1 Verification of Bending

$$\frac{C_f}{C_r} + \frac{U_{1x}M_{fx}}{M_{rx}} + \frac{U_{1y}M_{fy}}{M_{ry}} \leq 1$$

$$\frac{3}{535.5} + \frac{1 \times 23.48}{25.78} + \frac{1 \times 0}{25.78} \leq 1$$

$0.56 + 0.9108 + 0 = 0.92 \leq 1$, so the section is slightly oversized, but OK.

A.4.2 Verification of Shear

$$V_{fy} = 17.04 \text{ kN}$$

$$V_r = 0.66\phi(A/2)F_y$$

$$V_r = 0.66 \times 0.9 \times (2,690/2) \times 240 = 191,743 \text{ N} = 192 \text{ kN}$$

$$V_r = 191.74 \text{ kN} \geq V_{fy} = 17.04 \text{ kN} \quad \text{OK}$$

As bending governs, the 127 mm x 127 mm x 6.4 mm aluminum HSS is slightly oversized with the use of an 11.36 kN (2,500 lb) energy absorber in the HLLS, but it was nevertheless selected for the HLLS post.

A.4.3 Verification of Minimum Clearance

See section A.2.4.

A.5 Recap of Structural Analysis

Table A.1 sums up the assessment of the HLLS system with a 54 in. (1.37 m) fixed end, having an 11.36 kN (2,500 lb) energy absorber on the HLLS, for three different HSSs:

- 89 mm x 89 mm x 9.5 mm (3½ in. x 3½ in. x 3/8 in.) steel HSS
- 102 mm x 102 mm x 9.5 mm (4 in. x 4 in. x 3/8 in.) aluminum HSS
- 127 mm x 127 mm x 6.4 mm (5 in. x 5 in. x ¼ in.) aluminum HSS

This structural analysis of the HLLS, based on classical strength-of-materials methods, the design standards CAN/CSA-S157 – *Strength Design in Aluminum* (CAN/CSA-S157, 2000) and CAN/CSA-S16-1 – *Limit States Design of Steel Structures*, and the National Building Code of Canada (NBCC), shows that the HLLS prototype, made of an assembly of three 2 in. x 6 in. aluminum HSSs (equivalent to 6 in. x 6 in.) welded together, is clearly oversized, as a 102 mm x 102 mm x 9.5 mm (4 in. x 4 in. x 3/8 in.) aluminum HSS is an adequate section for the HLLS posts.

The 89 mm x 89 mm x 9.5 mm (3½ in. x 3½ in. x 3/8 in.) structural steel HSS, with a length of 4.87 m (16 ft.), while adequate, should be rejected because of its weight (107 kg), which is not consistent with the study objectives. The 102 mm x 102 mm x 9.5 mm (4 in. x 4 in. x 3/8 in.) aluminum HSS, with a length of 4.87 m (16 ft.) is a lighter alternative. It could have been chosen to make the HLLS posts, but since it is expensive and available by special order only, it was not selected. In its place, the 127 mm x 127 mm x 6.4 mm (5 in. x 5 in. x ¼ in.) aluminum HSS, albeit slightly oversized, is lighter than the 102 mm x 102 mm x 9.5 mm HSS (39 kg compared with 43 kg). The 127 mm x 127 mm x 6.4 mm HSS is also available commercially. It was therefore chosen for making the HLLS posts.

Table A.1 – Summary of verification of HLLS with a 54 in. (1.37 m) fixed end and an 11.36 kN (2,500 lb) energy absorber on the HLLS

Horizontal lifeline system (HLLS)	Verification of bending	Verification of shear	Analysis*	Length	Weight	Conclusion – Choice of post
Steel posts HSS: 3½ in. x 3½ in. x 3/8 in. (89 mm x 89 mm x 9.5 mm) Fixed end: 54 in. (1.37 m) Energy absorber: 11.36 kN (2,500 lb) on HLLS	$\frac{C_f}{C_r} + \frac{U_{1x}M_{fx}}{M_{rx}} + \frac{U_{1y}M_{fy}}{M_{ry}} \leq 1$ $\frac{3}{725.5} + \frac{1 \times 23.48}{25.4} + \frac{1 \times 0}{25.4} \leq 1$ $0.00414 + 0.92 + 0 = 0.93 \leq 1 \text{ OK}$	$V_f \leq V_r$ 17 kN ≤ 290 kN OK	HLLS OK, as bending governs	4.87 m (16 ft.)	107 kg (235 lb)	Too heavy: reject
Aluminum posts HSS: 4 in. x 4 in. x 3/8 in. (102 mm x 102 mm x 9.5 mm) Fixed end: 54 in. (1.37 m) Energy absorber: 11.36 kN (2,500 lb) on HLLS	$\frac{C_f}{C_r} + \frac{U_{1x}M_{fx}}{M_{rx}} + \frac{U_{1y}M_{fy}}{M_{ry}} \leq 1$ $\frac{3}{619.9} + \frac{1 \times 23.48}{23.79} + \frac{1 \times 0}{23.79} \leq 1$ $0.00484 + 0.98 + 0 = 0.99 \leq 1 \text{ OK}$	$V_f \leq V_r$ 17 kN ≤ 214 kN OK	HLLS OK, as bending governs	4.87 m (16 ft.)	43 kg (95 lb) OK	OK
Aluminum posts** HSS: 5 in. x 5 in. x ¼ in. (127 mm x 127 mm x 6.4 mm) Fixed end: 54 in. (1.37 m) Energy absorber: 11.36 kN (2,500 lb) on HLLS	$\frac{C_f}{C_r} + \frac{U_{1x}M_{fx}}{M_{rx}} + \frac{U_{1y}M_{fy}}{M_{ry}} \leq 1$ $\frac{3}{535.5} + \frac{1 \times 23.48}{25.78} + \frac{1 \times 0}{25.78} \leq 1$ $0.0056 + 0.91 + 0 = 0.92 \leq 1 \text{ OK}$	$V_f \leq V_r$ 17 kN ≤ 192 kN OK	HLLS slightly oversized, as bending governs	4.87 m (16 ft.)	39 kg (87 lb) OK	OK: This post was chosen

Note: Density of 6061 T6 aluminum = 2,700 kg/m³; Density of structural steel = 7,850 kg/m³

*Minimum clearance still needs to be determined with the manufacturer's technical data for the energy absorber (section A.2.4)

**Selected for HLLS posts

